



Make Us Your #1 Contact.

2024 Amateur Radio Products

The Industry's Most Powerful Website | World-Class Products Shipped Worldwide



Giving Back by...

Providing Gear to DXpeditions
Supporting Young Operators
Serving Our Communities



DXENGINEERING.COM | 800-777-0703

Butternut Antenna • Clifton Labs • Comtek • Hi-Z • KD9SV • TransWorld Antenna

Hello Friends,

Greetings from DX Engineering headquarters! We've worked hard filling our catalog with the latest and greatest amateur radio gear. Please enjoy looking through its pages as you plan to upgrade your station to make more contesting QSOs, fill your logbook with All Time New Ones, or prepare for a successful Field Day. Whatever your goals, our team will be here to support you every step of the way.

Offering friendly and knowledgeable guidance to our customers is one way DX Engineering is Giving Back to the hobby that has given us so much throughout our lives. I was fortunate to have patient mentors who encouraged my passion for ham radio more than 50 years ago, leading to a lifetime of unforgettable experiences and friendships. Every longtime operator at DX Engineering tells a similar story of Elmers who were there to answer questions, help build first stations, and pass on years of operating wisdom.

The tradition of Giving Back continues to be a cornerstone of what it means to be a ham. We've made it the theme of this year's catalog, but this phrase is more than a slogan to us. At DX Engineering, Giving Back is a philosophy that guides us as a company. We put this idea into action by...

- Serving as Volunteer Examiners, emergency operators, and club officers who aid our communities and tirelessly promote amateur radio
- Providing equipment for rare DXpeditions like Clipperton Island, TX5S, Swains Island, W8S, and many others
- Helping enthusiastic hams in countries that are still developing an on-air presence
- Supporting young hams through mentorship, unique operating opportunities, and donations of gear to build student stations
- Educating amateur radio club members via free Zoom webinars
- Producing free weekly informational content on social media
- Developing new products that make operating easier and more enjoyable

As more and more people get licensed, now is a great opportunity for all of us to consider how we can Give Back to the ham radio community. Together, we can ensure that the world's best hobby will continue to thrive for generations to come. On behalf of the entire DX Engineering team, let me thank you for choosing us for your ham radio needs. Please know that your support means the world to us.

I hope to hear you on the air soon!

73,
Tim Duffy
K3LR

Tim Duffy, K3LR
Chief Executive Officer



Philippians 2:3-4 (ESV)

Do nothing from selfish ambition or conceit, but in humility count others more significant than yourselves. Let each of you look not only to his own interests, but also to the interests of others.

DX ENGINEERING®

Expert Help is Just a Click Away!

Have questions about ordering and shipping? Looking for technical advice on your purchase? Get fast answers at the new DX Engineering Online Help Center. Just click the Help Center link at DXEngineering.com and the information you need is right at your fingertips. It's another way DX Engineering is making it easier than ever to enjoy the world's greatest hobby—Ham Radio!



- Billing & payment, product, order, shipping, returns, sales tax, and technical FAQs all in one place
- Searchable library of technical articles
- Optimized for any device—mobile, tablet or desktop
- Easy navigation and powerful keyword search
- New ways to contact DX Engineering SMS Texting, Facebook Messenger
- New content added regularly



TX5S Clipperton Island



8R7X Guyana



CBOZA Juan Fernandez Islands

DX Engineering Products Travel Around the Globe

Another way DX Engineering continues to support the hobby is through sponsorship of major DXpeditions. We remain committed to helping our fellow hams, as well as our own active operators, work the world!

Hams Giving Back

For more than two decades, DX Engineering has been committed to helping our fellow amateur radio enthusiasts and communities in any way possible, whether teaching Technician classes to aspiring operators, providing gear to rare DXpeditions, mentoring young hams, offering advice and needed equipment to build school stations, serving as members of local EMCOMM units, and promoting the world's greatest hobby whenever and wherever we can.

Why? Because we're hams like you who share a desire to see amateur radio flourish in the present and long into the future. Because giving back changes lives, makes our neighborhoods more prepared for emergencies, and brings excitement to operators everywhere. Just ask the lifelong DXer about the All Time New One he just made after 40 years on the air. Giving back matters. This is our passion and our purpose.

On the Cover

Supporting DXpeditions

We're proud to help DXpeditioners around the world log more QSOs by providing mission-critical equipment, including DX Engineering coaxial cable, tool kits, antennas, radial plates, and more. Photos on the cover represent just a few of the many recent operations supported by DX Engineering: Top left: CBOZA Juan Fernandez Island Team; second from right, WD5COV, Clipperton Island TX5S; top right: K08SCA, Bouvet Island 3Y0J; middle far left: Guyana 8R7X All-Youth Team; middle far right, EY8MM and WD5COV, Clipperton Island; middle small photo, NP4G, Bouvet Island; bottom second from left: HI3R/NK4DX and AB5EB, Juan Fernandez; bottom second from right, N6PSE, Clipperton Island; bottom far right, N7QT and AC7DC, Temotu Province H40WA.

Helping Young Operators Excel

K3LR, home station of DX Engineering CEO Tim Duffy, was the site of the 2023 Dave Kalter Memorial Youth DX Adventure—a unique opportunity for talented young hams, including Agnes, ADBIR (top middle) and Katie, KE8LQR (bottom far left), to gain invaluable experience operating from a powerful station during the RSGB IOTA Contest.



Free Zoom Webinars from DX Engineering: Make Your Next Amateur Radio Club Meeting a Huge Success

Looking for a sure-fire way to provide your amateur radio club with an informational and entertaining presentation for your next gathering? Members of the DX Engineering team, including CEO Tim Duffy, K3LR, are available to meet with your club through Zoom to deliver free educational webinars on a number of amateur radio topics, from contesting tips to station upgrades and maintenance. Club members will receive information they can use from experienced operators, plus answers to questions about getting the most out of their time on the air. Scheduling a presentation is easy. Just send an email to K8MNJ@DXEngineering.com.



DX Engineering's New Showroom: Worth the Trip!

Visit the expanded DX Engineering Showroom in the Summit Racing Retail Super Store near Akron, Ohio, to get on the air using the latest rigs via three HF beam antennas on our 80-foot tower; get up close to the hottest amateur radio gear; check out open box and scratch and dent items; talk with longtime hams who can answer your questions; and pick up your order. Curbside order pickup is also available. Showroom is open 9 am to 5 pm ET Mon.-Sat. Bring your friends and see you there!



WARNING

Proposition 65 Compliance Statement:  It is the responsibility of DX Engineering to warn its customers and employees that some products sold in this catalog contain chemicals known to the State of California to cause cancer, birth defects, or other reproductive harm. Go to DXEngineering.com/Go/FAQs-DXE-Prop65 for more information.

A	
Amplifiers & Accessories	4, 38-43, 92, 95
Antenna Analyzers	114-116
Antenna Hardware	84-88
Antenna Insulators	48
Antenna Switches/Console	4, 56-57, 90, 94
Antenna Tuners	4, 43-45
Antennas: Beam	65-71
Antennas: Discone	71
Antennas: Handheld	93, 100
Antennas: Hex Beam	4, 67
Antennas: Loop	52-55, 69-70, 93
Antennas: Mobile	94-100
Antennas: Phased Arrays	64-65, 89, 92
Antennas: Receiving	89-93
Antennas: Repeater	72
Antennas: Satellite	70, 95, 100
Antennas: Vertical	58-63, 65-72
Antennas: Wire	48-52
Apparel	29, 32-35
Audio Enhancement	19-26
B	
Baluns/UNUNs	46-47
Batteries	112
Books, Videos & Guides	10, 13, 26-29
C	
Chokes/RF Filters	46-47, 91, 93
Clamps	80, 84, 86-88, 106
Cleaners	122
Coaxial Cable & Assemblies	4, 127, 130
Connectors	49, 123-127
CW Keys and Accessories	35-36
Contesting Accessories	7-8, 19, 28, 41
D	
Digital Atlas	31
Digital Mode Interfaces	18
Dummy Loads	36-37, 113
Duplexers/Multiplexers	4, 55, 73
E	
Equipment Cases & Storage	120-121
Equipment Covers	10
F	
Ferrites	47
Filters: Band Pass/High/Low	4, 55
Footswitches	22-23
G	
Generators	112
Grounding	80, 101-105
Guying	48, 60, 80-81, 83
H	
Headphones & Headsets	4, 22-24

K	
Keys, Paddles & Accessories	35-36
L	
Ladder Line	48
Lightning/Surge Protection	81, 101-105
Lubricants & Anti-Seize	82, 122
M	
Masts: For Towers	80-88
Masts: Portable	53, 82
Microphones	15, 25-26
Mobile Antennas	94-100
Mobile Radio Mounts and Stands	10-12
Mobile Transceivers	10-14
O	
Ordering Information	74
P	
Power Accessories	108-112
Power Supplies	106-108
Powerpole Accessories	108, 110
Preamplifiers	90-91
R	
Radials & Radial Plates	60-62
Radios: AM/FM/SW Broadcast	30, 32
Receivers	17, 114
Receiving Antennas	89-93
Rotators & Controllers	75-77
S	
Satellite Tracking	76
Shack Accessories	29, 31-33
Software	7, 17, 85
Soldering	118-119
Speakers	6, 9, 19-22
Starter Packages	5
T	
Test Equipment	37-38, 113-116
Cable Management, Heat Guns, Tools & Storage	82, 110, 117, 120-121, 123-127
Towers & Accessories	77-88
Transceiver Accessories	6-16
Transceivers: Base	6-10
Transceivers: Handheld	4, 14-16
Transceivers: Mobile	10-14
Triplexers/Multiplexers	4, 55, 73
Tubing	61, 82-83
W	
Warranty Information	74
Wattmeters	37-38, 109, 113
Weather Stations	30-31
Weather/Emergency Radios	30, 32
Weatherproofing	105, 122

DX Engineering carries equipment from more than 175 top manufacturers!

New Gear from the Team at DX Engineering

DX Engineering is constantly looking for ways to make your ham radio experience more effective and enjoyable. From this "build a better mousetrap" spirit comes practical and innovative offerings from our team, including DX Engineering Icom and Yaesu Radio Go Box Kits (page 5); Multiband Off Center Fed Dipole Antenna Kit (page 51); Super Duty Rotator Mast Clamps (page 75); Receive Antenna Matching Transformer (page 89); Transmit Receive Interrupter Plug-In Module for the DXE-NCC-2 (page 91); newly designed 160M Add-On Kit for Buttertern Verticals (page 61); plus new DX Engineering camo hat, kneeling pad, gel mouse pad, work shirt, and more (pgs. 32-35).

**403A NC-1
Noise-Canceling
Headset and Accessories****New!**4 |  3A

From 403A comes the premium NC-1 headset that's ideal for contesting or listening to your favorite music. The light and comfortable NC-1 features over-the-ear stereo Bluetooth headphones that upgrade with a plug-in condenser boom microphone. Enjoy crystal clear audio for contesting, wide frequency response, a top-notch 25 dB noise canceling system, Bluetooth 5.0 and an internal microphone for mobile devices, a USB-C cable, and internal rechargeable 750 mAh Li-Ion battery for up to 30 hours of operation. Headphone and boom mic also sold separately. Headset-Transceiver 8-pin round mini adapters and audio adapters sold separately.

403A NC-1 Headset and Accessories..... see page 22

**10JXX Antennas
and Accessories****New!**

10JXX is recognized by hams worldwide for their innovative designs, use of quality materials, and excellent workmanship in every antenna and part they produce. DX Engineering is pleased to now offer an excellent selection of high-performance 10JXX 23cm Yagis, 70cm Yagis, VHF/UHF log-periodic dipole arrays, 2M Yagis, 6M Yagis, 6M/2M Yagis, 2320 MHz Yagis, and finely constructed parabolic antenna feedpoint elements. Enter "JXX" at DXEngineering.com for more details.

FlexRadio**Genius Solutions Amplifier,
Tuner, and Antenna Switch****New!**

DX Engineering now carries three performance-enhancing devices from FlexRadio's Genius Solutions' lineup. For pricing and more details, enter "Genius Solutions" at DXEngineering.com.

**Power Genius XL HF+6
1,500W+ Amplifier**

The solid state PGXL 160-6M amplifier delivers full legal-limit power in all modes at 100% ICAS duty cycles. FlexRadio says the device, measuring 6" H x 20" W x 14" D and weighing 39.6 lbs., is the only fully SO2R-capable amplifier on the market with 70 dB nominal isolation between transceiver inputs. Other features include a Maximum Efficiency Algorithm (MEffA™) system that controls efficiency as a function of output; smart cooling control with real-time settings of drain voltage, drive, and fan speed; ultrafast SWR protection; CAT, band decoder, LAN interface for operation with other excitors; and network capability with built-in Ethernet connection, meaning it seamlessly integrates with any Flex-6000 Series radio.

Tuner Genius XL

Designed to complement Flex-6000 Series transceivers and the Power Genius XL amplifier to gain full SO2R operation, the TGXL tuner—the first SO2R tuner in the amateur market—provides coverage from 1.8-54 MHz with the ability to tune up to 10:1 SWR and handle up to 2000W ICAS of power. The tuner's functions can be controlled from either its front panel or by using Windows software, allowing it to be placed off the desktop if needed. The device includes "peak responding" RF power and SWR displays, and can be integrated with any modern HF radio.

Antenna Genius 8x2 Switch

Designed for LAN/WAN control and to make the most out of your dual RX transceiver, this smart matrix antenna switch supports eight antennas and two radios. The AG-2X8 features a hardware-level interlock system to prevent two radios from connecting to the same antenna, safeguards against RX antennas being used for TX, automatic antenna switching for FlexRadio rigs, rugged stainless steel chassis with wall-mount flange, and user programmable band ranges.

**VE2DX Electronics**

DX Engineering carries innovative VE2DX Electronics products including TrueCIV Icom Transceiver Hubs that connect the interfaced transceiver's CI-V data stream to multiple accessories simultaneously, providing unmatched CI-V signal performance, signal integrity, maximum link length, and RFI prevention. Data hubs featuring CI-V over Bluetooth provide an electronic solution for the missing physical CI-V port on the IC-705. Other products include the Icom Digital Meter HDMI Display TrueCIV Interface, a small device that connects Icom transceivers to any size HDMI flat panel monitor or TV for an impressive multi-function meter display; Portable Icom Two-Inch Digital Meter Displays; and 2x6 antenna switches.

VE2DX TrueCIV Icom Transceiver Hubs and Digital Meter Displays..... see page 7
VE2DX 2x6 Antenna Switches..... see page 56

DX
VE2DX ELECTRONIC
New!**VA6AM HF Transmit
Band Pass Filters and
Multiplexers****VA6AM**
TRIPLEXERS-DIPLEXERS-FILTERS
New!

Perfect for multi-multi contest stations and Field Day, HF transmit band pass filters by Pavel, VA6AM, provide a dramatically lowered noise floor for enhanced single-band, weak-signal reception. They deliver the isolation needed to eliminate image and harmonic RF interference issues for dedicated monoband operations in multi-radio environments. The 150W PEP filters boast 60 dB of out-of-band suppression. When used with these filters, VA6AM receive and transmit capable RF-filtering splitters/combiners allow multi-transceiver stations to share a single multiband antenna, delivering excellent levels of isolation between band ports.

VA6AM Band Pass Filters and Multiplexers see page 55

**DIEX Rotatable Dipole
HF Antennas****DIEX**
New!

For two decades, Brazilian-based DIEX Antennas has been providing a proven solution for space-limited operators. The company's single-band full size, multiband shortened, single-band coil shortened, two-band coil shortened, and multiband trap shortened rigid rotatable dipole HF antennas are built with quality materials, provide good directionality, deliver impressive power handling, and offer the flexibility to make adjustments to set the lowest SWR.

DIEX Rotatable Dipole HF Antennas..... see page 68

**OM Power 1,500W+
Linear Amplifiers****OM**
POWER
New!

DX Engineering is the exclusive North American distributor of products from OM Power, a company known for producing high-performance tube-style amps since 2004. Their manual and auto tune HF, HF+6, HF+MARS, and HF+6+MARS models feature FU-728F tetrode tubes capable of providing full legal-limit output power; 4.3" color touchscreen; advanced protection circuitry; and much more.

OM Power Amplifiers..... see page 42

REZ Antenna Systems

The Ranger 80 HF Portable Antenna System from Texas-based REZ Antenna Systems takes the hassle out of portable ops. You receive an adjustable base-load tuning coil that allows for tuning from 80-15M with the included seven-section military whip; radial puck; four 33" radials for connection to the puck; and MOLLE backpack. Kits either include 17" ground spike or tripod mount.

REZ Ranger 80 Portable Antenna System ...see page 52

REZ
[ANTENNA SYSTEMS]
New!**GMRS 5W UHF
Handheld Transceiver****New!** **ALINCO**

This rugged, compact, and versatile IP54-weatherproof GMRS general-purpose two-way radio is a great way to keep in touch with friends and family at sporting events, theme parks, the mall, while camping, and during travel adventures. The FCC Part 95-certified handy-talkie includes 128-channel capability; 5W GMRS, 2W FRS output; LCD screen; GMRS repeater-readiness; CTCSS/DCS group talk tones; emergency call function; hands-free VOX; FM radio; 1700mAh Li-Ion battery; and more. While this radio shares the same channels as the Family Radio Service (FRS), a license is required to operate the DJ-G46T because it offers more power and range over traditional FRS models. Accessories also work with select other Alinco HT models.



ALO-DJ-G46T 5W GMRS UHF HT.....CALL/WEB
ALO-EME-56A L-Type Earphone/Mic.....\$34.99
ALO-EDH-40 Mobile DC Cigarette Adapter; \$19.99
ALO-EMS-76 L-Type Speaker Mic\$42.99

DX ENGINEERING**Single-Band Low-
Power Dipole Kit**

Looking for the perfect project for your club, scout troop, or STEM group, or a way to introduce ham radio to your kids or grandchildren? The Single-Band Low-Power Dipole Kit gives you the essentials to build a dipole antenna: a center insulator, two end insulators, and a right angle BNC connector. The center insulator and end insulators are essentially printed circuit boards. Once assembled, the center insulator doubles as a wire winder. The end insulators also function as rulers, aiding in antenna tuning. You provide the coaxial cable, light support rope, and 14 to 26 gauge wire cut to the length of your desired frequency. Solder the six soldering points and you're ready to fine-tune your antenna and get on the air! Enter "DWK" at DXEngineering.com.

Single-Band Low-Power Dipole Kit

DXE-DWK Each\$9.99
DXE-DWK-10 Pack of 10\$99.99
DXE-DWK-25 Pack of 25\$199.99

DX ENGINEERING**Orange RG-8X Coaxial Cable**

DXE-8XV RG-8X coaxial cables are covered in a non-contaminating orange PVC jacket, so you get the high-performance benefits of DX Engineering RG-8X low-loss 50 Ω coax plus high-visibility that ensures your installations will be visible to all. Available by the foot, as assemblies with DX Engineering's patented PL-259 connectors, or in a 1,000-foot spool.



DXE-8XV-1000 Orange RG-8X, 1,000' Spool.....\$685.99
DXE-8XV Orange RG-8X, per Foot.....\$69
DXE-8XVDX025 Orange RG-8X Assembly, 25' with PL-259s.....\$59.95
DXE-8XVDX050 Orange RG-8X Assembly, 50' with PL-259s.....\$79.99
DXE-8XVDX100 Orange RG-8X Assembly, 100' with PL-259s.....\$119.99

Most in-stock parts ship throughout the contiguous US in just 1-2 days!

Getting Started Packages and Go Boxes

Building your first Ham Radio station can be overwhelming. In the Elmer spirit, we've created Getting Started Packages that illustrate what it takes to get on the air for three operating styles: base, mobile and handheld. The packages are built around popular radios, good for beginners and experts alike. Of course, these are just suggestions and each part is available separately, so you can build your own custom combo using whatever component you want. Type "Getting Started" into the search box at DXEngineering.com to see details.



Getting Started Mobile Radio Packages

Based around your choice of a 2 meter mobile transceiver, these combos will show you what typically goes into a mobile station. There are three mounting options for each radio combo: magnet, trunk/hatch or luggage rack. Each combo also includes a 2M or 2M/70cm mobile antenna and the right coaxial cable (with installed connectors) to complete a hassle-free installation.

Package Part Number	Radio	Antenna	Mount	Price
DXE-MBLICO3500LG	Icom ICO-V3500	52.4" Monoband	Luggage Rack	\$341.92*
DXE-MBLICO3500MG	Icom ICO-V3500	40.2" Dual-Band	Magnet	\$343.93*
DXE-MBLICO3500TR	Icom ICO-V3500	52.4" Monoband	Trunk/Hatch	\$331.92*
DXE-MBLYSU3100LG	Yaesu FTM-3100R	52.4" Monoband	Luggage Rack	\$318.92*
DXE-MBLYSU3100MG	Yaesu FTM-3100R	40.2" Dual-Band	Magnet	\$293.93*
DXE-MBLYSU3100TR	Yaesu FTM-3100R	52.4" Monoband	Trunk/Hatch	\$293.93*

More Getting Started Packages Online.



DXE-GOBOX-1



DXE-GOBOX-2

New!



DXE-GOBOX-1



*See DXEngineering.com for special promotional pricing.



DXE-HTICO-ICV86 DXE-HTALO-VX50T DXE-HTYSU-FT65R

Getting Started HT Radio Packages

For many newly licensed Hams, the quickest way to start enjoying the hobby is with a handheld transceiver, commonly referred to as an HT or "Handie-Talkie." We've made it easy to get on the air with three new packages that take the guesswork out of making your first contacts. Packages include a top-quality radio from Alinco, Icom, Kenwood or Yaesu; an upgraded Diamond HT Antenna; radio-specific programming software and cable from RT Systems; and speaker microphone or headset for convenient operating and clear audio. Enter "Getting Started" at DXEngineering.com for full details.

- DXE-HTALO-VX50T Alinco DJ-VX50T 2M/70cm HT, Speaker Mic, Software/Cable, Dual-Band Antenna\$236.92
- DXE-HTICO-ICV86 Icom ICO-ICV86 2M HT, Speaker Mic, Software/Cable, Monoband Antenna.....\$264.92
- DXE-HTYSU-FT65R Yaesu YSU-FT-65R 2M/70cm HT, Speaker Mic, Software/Cable, Dual-Band Antenna.....\$229.92



Icom and Yaesu High-End Getting Started Packages

Give yourself an operating advantage right out of the gate by choosing packages featuring high-end analog/digital rigs—either the Icom ID-52A VHF/UHF Multi-Function D-STAR HT or the Yaesu FT5DR VHF/UHF C4FM/FM HT. In addition to these full-feature transceivers, packages include upgraded speaker mic, RT Systems cable/programming software combo, chargers, battery pack and more.

- DXE-ID52ASTART1 Icom ID-52A Getting Started Package.....\$1,130.79
- DXE-FT5DRSTART1 Yaesu FT5DR Getting Started Package \$719.86



Getting Started Packages for Base Operations with a Mobile Transceiver

DX Engineering offers two brand new Getting Started Mobile Transceiver Packages that are completely equipped for base operations! Each package has a quality all-mode mobile/base rig (choose from Icom or Yaesu) with handheld mic, desktop switching power supply, HF automatic antenna tuner with radio interface cable, HF end-fed half-wave dipole antenna, and coaxial cable assemblies. The Icom package also comes with a 2M/440MHz VHF-UHF dual-band antenna.

The DXE-FT891START-1 package includes:

- Yaesu FT-891 HF/50MHz All Mode Mobile Transceiver with Handheld Speaker Mic
- LDG Z-100PLUS Automatic Antenna Tuner and Interface Cable
- Samlex SEC-1235M Desktop Switching Power Supply
- 50' of RG-8X Coaxial Cable with PL-259 Connectors
- Par EndFedz® End-Fed Half Wave Antenna (EF-8010-JRKW), 80/40/20/15/10, 1 kW power
- DXE-FT891START1 Yaesu FT-891 Mobile Radio Getting Started Package **CALL/WEB**

The DXE-IC7100START-1 package includes:

- Icom IC-7100 HF VHF/UHF All Mode Base/Mobile Transceiver with Handheld Speaker Mic
- LDG Z-100PLUS Automatic Antenna Tuner and Interface Cable
- Samlex SEC-1235M Desktop Switching Power Supply
- 50' of RG-8X Coaxial Cable with PL-259 Connectors
- 50' of 400MAX Coaxial Cable with PL-259 Connectors
- Par EndFedz® End-Fed Half Wave Antenna (EF-8010-JRKW), 80/40/20/15/10, 1 kW power
- Diamond X30A Dual-Band Base/Repeater Antenna
- DXE-IC7100START1 Icom IC-7100 Mobile Radio Getting Started Package..... **CALL/WEB**



Join our crew on Facebook for news and exclusive deals!

HF/UHF/VHF Go Box Kits

DX Engineering makes it easy to put together a Go Box for portable operations with these two kits featuring top-grade transceivers from either Icom or Yaesu, plus quality equipment case, rack shelving, and accessories.

Icom Go Box Kit: IC-7300 HF/50 and ID-5100A-D VHF/UHF Mobile

You also receive a Gator Cases Pro Series Equipment Rack (19" D x 10" H), two rack shelves, mobile mounting brackets, mobile suction cup mount, mAT-TUNER automatic antenna tuner (1.8-54 MHz), two SP-35 mobile speakers, and West Mountain Radio RIGrunner DC outlet panel.

DXE-GOBOX-1 Icom Go Box Kit **\$2,801.72**

Yaesu Go Box Kit: FT-710 AESS HF/50 Base/Portable and FTM-500DR C4/FM 144/430 MHz Digital Mobile
 You also receive a Gator Cases Pro Series Equipment Rack (19" D x 13.5" H), three rack shelves, mobile mounting bracket, mAT-TUNER automatic antenna tuner (1.8-54 MHz), SP-40 desktop speaker, West Mountain Radio RIGrunner DC outlet panel, West Mountain Radio Epic PWRgate battery backup system, Yaesu FP-1023A switching power supply, and Bioenno Power LiFePO4 battery (12 VDC, 20 Ah, 40A, 480W max).
Enter "DXE GOBOX" at DXEngineering.com for more details about both kits.

DXE-GOBOX-2 Yaesu Go Box Kit **\$3,340.68**



IC-7610 HF/50 MHz Transceiver

Icom's IC-7610 gives your station the edge with all-mode RF direct sampling. Combining a dual preselector and band pass filtering with the power of a Software Defined Radio (SDR), advanced Reciprocal Mixing Dynamic Range (RMDR) over 100 dB is achieved for both independent receivers. The IC-7610 can pick out the faintest signals in the presence of stronger, adjacent signals, delivering the ultimate advantage for DXers and contesters—with rich rewards for casual operators. It covers 160 through 6M with 100 watts, featuring a remarkable seven-inch high-resolution color touchscreen, intuitive controls, real-time dual spectrum scope, waterfall and audio scope displays, Quick Split and Dual Watch, remote control LAN port, Receive IN and OUT, clean transmit, general coverage 30 kHz-60 MHz, and more. The IC-7610 can take your station to the next level.



- Other features include:
- DIGI-SEL Preselector, Digital IF Filters, and Twin Band Pass Tuning
 - Superior audio with a large internally enclosed speaker
 - Custom VCO driven master clock for ultra-low phase noise
 - External monitor DVI-D port, I/Q signal output port, and 10 MHz Reference input
 - Dual port USB: internal audio digital mode and rig control interface
- | | | |
|-------------|---|-----------------|
| ICO-IC-7610 | IC-7610 HF/50 MHz Transceiver..... | CALL/WEB |
| ICO-SP-41 | IC-7610 Companion External Speaker..... | \$269.99 |

- Optional SD card slot for saving user profiles, memory keyer, and voice files
 - Simplified remote operation with optional RS-BA1 Remote Control Software
 - Independent second receiver tuning with optional RC-28 USB Encoder
 - Built-in automatic antenna tuner
 - Long list of CW, receiver, transmitter, and operational benefits
- | | | |
|-------------|---|----------------|
| ICO-MB-121 | Replacement Carrying Handle Kit for IC-7610 | \$34.99 |
| XYZ-32GB-SD | 32 GB Ultra High Speed Memory Card | \$19.99 |



ICOM IC-7300 HF/50 MHz Transceiver

Icom's first RF Direct Sampling System entry-level SDR, the IC-7300 changed the HF transceiver landscape in 2015 with a highly affordable, high-performance base/portable HF radio. In addition to the classic SSB, CW, RTTY, AM and FM modes, updated firmware brings improved functionality including a simplified FT8 mode preset. Featuring excellent receiving characteristics, this 160-6 meter model includes a touchscreen display, real-time spectrum scope and high-resolution waterfall, touch-tuning on the spectrum scope, an intuitive MULTI-function knob, dual port USB control and audio, and much more. Building all this into a rugged and compact chassis was a landmark achievement—and the IC-7300 is still an easy-to-use choice for your portable or EMCOMM station. This versatile and budget-friendly radio delivers excellent performance, easy filter adjustments, and remarkable audio clarity. The IC-7300 provides SDR performance, the controls of a classic transceiver, and the modern simplicity of a touchscreen spectrum scope display.

- Voice memory & memory keyer
- Multi-function meter
- SD card slot
- Screen capture
- 100 W (25 W AM)
- Digital noise reduction

Find the full details on the IC-7300 at DXEngineering.com.

ICO-IC-7300	HF/50 MHz Transceiver	CALL/WEB
ICO-MB-118	Mobile Mounting Bracket	\$47.99
ICO-MB-123	Transceiver Carry Handle.....	\$36.99
ICO-SP-38	Base Station Speaker.....	\$186.99
XYZ-32GB-SD	32 GB Ultra High Speed Memory Card	\$18.99



ICOM IC-9700 VHF/UHF/1.2 GHz Transceiver

Built for those who relish the challenge and rewards of VHF/UHF weak-signal operating, ICOM's IC-9700 delivers the goods. It's an RF direct sampling receiver for 2m and 70cm, with a single, down conversion for 23cm with an IF sampled receiver between 311 – 371MHz. Operators can expect a quiet receiver thanks to the rig's DSP technology. The powerful PA provides 100W on 2m, 75W on 70cm, and 10W on 23cm. The IC-9700 comes with band-specific memory channels, and the ability to adjust band-specific receiver and transmit settings, including noise blanker, noise reduction, RF power, TX power limit, and TX delay. Here are just a few more of its many features:

- Supports CW/AM/SSB/SM/RTTY/FM and D-STAR DV and Digital Data (DD) modes
- DD mode provides 128 kbps data communication
- Smooth satellite operation with normal/reverse tracking and 99 satellite channels
- Real-time, high-speed spectrum scope and waterfall display
- Dualwatch operation and full-duplex operation in the satellite mode
- Audio Scope
- 4.3" touch screen color TFT LCD
- Main or Sub-Band Scope
- Supports 2 band simultaneous reception
- Dual D-STAR receive (decodes two voice streams simultaneously)

Get more details by entering "9700" at DXEngineering.com.

ICO-IC-9700	IC-9700 VHF/UHF/1.2 GHz Transceiver	CALL/WEB
ICO-SP-38	Base Station Speaker.....	\$186.99
ICO-MB-123	Transceiver Carry Handle.....	\$36.99
ICO-MB-118	Mobile Mounting Bracket	\$47.99
XYZ-32GB-SD	32 GB Ultra High Speed Memory Card	\$18.99



Panadapter Module for Icom IC-7300 Transceiver

Think one of Icom's most beloved transceivers, the IC-7300, couldn't get any better? Think again! IC-7300 owners who have always wanted to view the rig's panadapter in an easier-to-see format can now do so with Radio Analog's PTRX-7300 IF Interface Module and your external SDR receiver. Available exclusively in North America from DX Engineering, this impedance matched and buffered device samples filtered receive and transmit IF signals from the IC-7300 for your SDR receiver spectrum scope display—without soldering, signal loss or disruption to the transceiver's proper function. It installs easily into the IC-7300, adding an IF connector on the rig's rear for connecting your SDR receiver to put the IC-7300's own signals onto a much larger screen. You can even sync the tuning of the SDR to the IC-7300 with third-party rig control software. Output and input connectors in this latest version are SMA, providing more robust, longlife connections and easy access to connectors at the rear panel without need for adapters. DX Engineering offers the DX Patrol MKIV SDR Receiver (DXP-DX-PATROLMK4) to use as the PTRX-7300 panadapter companion for your PC, laptop, MAC or mobile device.

LOG-PTRX-7300-V2	Panadapter Interface Module for IC-7300, Version 2.....	\$299.99
------------------	---	-----------------



Panadapter IF Interface Module for Icom IC-9700 Transceiver

On the heels of Radio Analog's PTRX-7300-V2 panadapter module for the IC-7300 comes its new model that lets you view the IC-9700's panadapter in an easier-to-see, larger-screen format when combined with your external SDR receiver. Designed for exceptional performance and hassle-free installation in minutes (with no modification needed at the rig's rear panel, no compromise in the radio's performance, and no soldering or special skills required), the PTRX-9700 can be installed using only a screwdriver and provided special tool and has been designed so installation can be fully reversed. Further, you can sync the tuning of the SDR to the IC-9700 with third-party rig control software. Kit includes panadapter main board, reference injection board, mounting parts, power cable, UFL-F cable assemblies, and SMA-M/SMA-M coaxial cable.

LOG-PTRX-9700	RF/IF Panadapter Kit for Icom IC-9700	\$359.99
---------------	---	-----------------

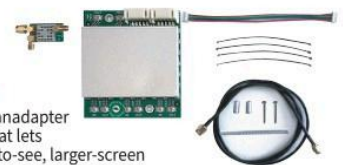

Orders over \$99 qualify for FREE standard shipping—see pg. 74 for details.

Multi-Port Icom Transceiver Interface Data Hubs and Digital Meter Displays



New!

Display using VEX-IM1-HDMIV2



VEX-CT17B-7DMV2

Based in Quebec, VE2DX Electronics has been dedicated to improving the on-air experience for hams everywhere. DX Engineering carries innovative VE2DX products including TrueCIV Icom Transceiver Hubs. These hubs connect the interfaced transceiver's CI-V data stream to multiple accessories simultaneously, providing unmatched CI-V signal performance, signal integrity, maximum link length, and RFI prevention. Units are designed to deliver perfect CI-V data to many types of tuners, band pass filters, smart antenna switch controllers, and more. From the legacy IC-735 to the IC-7300 and IC-9700, these hubs interface all Icom CI-V 3.5mm remote port radios to all types of station devices through use of 3.5mm patch cables. Data hubs featuring CI-V over Bluetooth provide an electronic solution for the missing physical CI-V port on the IC-705. Enter "VEX" at DXEngineering.com for more details on VE2DX products.

- VEX-CT17B-5 Interface Data Hub, Passive \$75.99
- VEX-CT17B-5V2 Interface Data Hub, USB-C Port \$94.99
- VEX-CT17B-6BTV2 Bluetooth Data Hub, USB-C Port, CI-V to PC Via Bluetooth \$124.99
- VEX-CT17B-6USBV2 USB Data Hub, USB-C Port, CI-V to USB PC \$113.99
- VEX-CT17B-7DMV2 USB/Bluetooth Data Hub, USB-C Port, CI-V to PC Via Bluetooth \$146.99

Icom Digital Meter HDMI Display TrueCIV Interface

This small electronic device connects Icom transceivers to any size HDMI flat panel monitor or TV for an impressive multi-function meter display. It simultaneously interfaces to a PC and multiple accessories via USB, Bluetooth, and CI-V.

- VEX-IM1-HDMIV2 Digital Meter HDMI Display/TrueCIV Interface \$146.99

Portable Icom Two-Inch Digital Meter Displays

These meter display and TrueCIV data hubs work for most Icom rigs. Their unique mini screen can show two bar graph meters or two needle meter displays, as well as other transceiver status indicators as selected by two front panel buttons. They also interface Icom transceiver CI-V data simultaneously to a PC and multiple accessories via USB, Bluetooth, and CI-V—the TUFF version is made for portable use.

- VEX-IM14BTPLUSV2 Icom 2" Digital Meter Display \$174.99
- VEX-IM14BTTUFFV2 Icom 2" Digital Meter Display, Waterproofed \$212.99

Click2Tune Transceiver Keying Switch

Here's fantastic news if you use an ICOM HF transceiver with an antenna tuner or amplifier. SOTABeams makes it easy to send a low-power carrier for tuning purposes—an annoyance if your antenna requires frequent retuning or if you use your rig with an amplifier. The Click2Tune Transceiver Keying Switch puts you in control by letting you transmit a low-power carrier without any need to change the mode, reduce power or press the PTT. The keying switch works with most ICOM transceivers with 4-Pin molex tuner connector, including IC-7300, IC-7100, IC-746 (ant. 1), and IC-9100 (ant. 1).



- SBM-CLICK2TUNEKT Transceiver Keying Switch for ICOM Radios, Kit \$16.99

Ham Radio Deluxe Software
The Radio Amateur's Best Asset



Ham Radio Deluxe Software for Windows

Billed as the "World's Most Popular Ham Radio Software," the HRD suite gives you full command of your transceiver from your computer screen, lets you monitor amateur radio satellites, simplifies logging and tracking of QSOs, provides easy rotator control, and provides support of digital modes in a single package. Choose from five provided modules: HRD Rig Control, which lets you take advantage of computer control features built into the transceiver; HRD Logbook, which lets you keep track of all QSOs and provides automatic logging of FT8 contacts; Digital Master, which provides support for CW, RTTY, PSK31, FT8, and more; HRD Satellite Tracking, which lets you stay apprised of a satellite's footprint, projected path, and predicted elevation for given passes; and HRD Rotator Control, which manages beam headings via any computer-interfaced rotator controller. Note: This is only a short description of everything these modules offer. The HRD suite is available as a full-version perpetual license key sent from DX Engineering. You pay a one-time cost for lifetime use of the software, plus one year of updates and direct support. An additional annual fee gives you updates and support beyond the first year. Users require Windows 10 or 11 and minimum of 4GB of memory. Enter "HRD Deluxe" at DXEngineering.com for more details.

- HSW-HRD-SW Ham Radio Deluxe Software License Key \$99.95

Remotely Control Icom Transceivers Through an IP Network!



IP Remote Control Software, Version 2USB
The IP Remote Control Software allows you to operate an Icom radio installed in another room using your home network or even from a remote location over the Internet. The software works with Icom IC-705, IC-9100, IC-7800, IC-7700, IC-7600, IC-7610, IC-756PROIII, IC-746PRO, IC-7400, IC-7200, IC-7300, IC-7850LE, IC-7851 and IC-7000 transceivers. Version 2USB upgrades include the ability to select between normal and large panel size, indicator click operation to change settings, RIT and TX functions, mute button and SUB dial. All you need is Windows 10 and high-speed Internet connections at each end for best results. Windows 8 and 8.1 are also supported. Comes with thumb drive and USB A-B cable. Enter "ICO IP Remote" at DXEngineering.com for more details.

- ICO-RS-BA1-V2USB IP Remote Control Software, Version 2USB \$159.99

ICOM			ICO-IC-718	ICO-IC-7300	ICO-IC-7610	ICO-IC-7851	ICO-IC-7100
Accessory	Part Number	Description					
Antennas	ICO-AH-2B	Antenna Element with Base, Compatible AH2, AH3 and AH4	X	X	X		X
	ICO-AH-710	Folded Dipole	X	X	X		
	ICO-AH-740	Relay, Driven Compant Automatic Tuning Antenna, 1.6-29.999 MHz	X	X	X		
Cables	ICO-OPC-1457	Power Cable, DC, 4-Pin, 9.8', ATO/ATC Inline Fuse Holder			X		X
	ICO-OPC-1529R	RS232 Type PC/GPS Cable					X
	ICO-OPC-2361	DC Power Cord, Same As Supplied	X	X	X		
	ICO-OPC-510	AC Power Cable				X	
Control Cable Adapters	ICO-OPC-599	Accessory Port Y-Adapter, 13-Pin DIN Plug to 7-Pin and 8-Pin DIN Receptacles	X	X			X
	ICO-OPC-2321	Control Cable Adapter to 4-Pin Type for AH740	X	X			
Hand Mic	ICO-HM-219	Hand Microphone, Same as Supplied	X	X	X		
Remote Control	ICO-RC-28	Remote Control USB Encoder, with Tuning Knob and Transmit Button			X	X	



ContestConsole Switching Unit for Icom Radios

Connect this easy-to-use control switch unit between your microphone and ICOM rig for instant access to voice, CW and PSK memories without the need to display them on the transceiver screen. It features a TX PTT button, TX low power tune function, push-button frequency control, external PTT footswitch socket, 3.5 mm auxiliary microphone socket, and more. The unit supports the IC-7300, IC-7400, IC746PRO, IC-756PROIII, IC-756PROIII, IC-7600, IC-7610, and IC-9100 transceivers. An adapter cable (OPC-589) is required if the radio has a modular microphone connector instead of an 8-pin round microphone connector.

Enter "ContestConsole" at DXEngineering.com for full details.

- SBM-CONTESTCONSL ContestConsole Switching Unit for Icom Radios \$99.99
- SBM-CC-LEAD-KT Tune Lead for ContestConsole, Kit \$12.99

Need help with your project? Call the tech line at 330-572-3200!

YAESU

FTdx-101D and FTdx-101MP HF/50MHz Transceivers

Yaesu's two industry-leading rigs have achieved unrivalled dual-receiver performance with innovations designed for the ultimate radio operating experience. The leading-edge hybrid-SDR architecture of the FTdx-101D 100 watt and FTdx-101MP 200 watt transceivers are both packed with features for radio enthusiasts, DXers, and serious contesters: 160-6 meter coverage; large touch-panel color display with dual multi-function meters; dual frequency readouts and multi-functional touch controls; intuitive menus; real-time Three Dimension Spectrum Stream and 2-D waterfall and panadapter scope; dual LED push-buttons to enable effortless, rapid independent band changes; Yaesu's renowned interference reduction system and 400 MHz High Resolution Direct Digital Synthesizer; two identical and independently controlled receivers and phase-locked diversity dual-receive with two speakers or headphones. Both models deliver superb close-in dynamic range performance, even in crowded bands. The Direct Sampling SDR section provides astounding visual awareness of activity across the band and near the operating frequency on each receiver. Get the full story by entering "FTDX" at DXEngineering.com.

Other highlights of this contest-class transceiver include:

- Active band monitor
- DSP auto notch
- General coverage RX
- Ergonomically arranged transceiver controls
- High-Q VC tuning front-end
- 9 MHz IF roofing filter
- 32 Bit IF DSP and digital noise reduction
- Ultra-low phase noise 1st local oscillator

YSU-FTDX-101D*	HF/50MHz Transceiver, 100 Watt.....	CALL/WEB
YSU-FTDX-101MP*	HF/50MHz Transceiver, 200 Watt, with SPS-101 Speaker/Power Supply Included.....	CALL/WEB
YSU-SP-101	Desktop External/Secondary Speaker for FTdx-101D/MP.....	\$219.99
YSU-SSM-75G	Replacement Speaker Mic for FTdx-101D/MP.....	\$59.99

*Additional filters and VC-TUNE are available for installation. Call and speak with a sales rep for details.



YSU-SP-30



YSU-XF-130CN

YAESU

FTDX10 Compact HF/50 MHz 100W SDR Transceiver

Whether you're in the market for a base or portable rig—or both—look no further than Yaesu's latest transceiver, the FTDX10. It utilizes the Yaesu Hybrid SDR configuration—Narrow Band SDR and Direct Sampling SDR—like the FTDX101 series. The Narrow Band SDR receiver emphasizes excellent receiver performance, while the Direct Sampling SDR provides a Digital Processing Real-Time Spectrum Scope.

The radio is loaded with features, including 15 separate band pass filters; effective QRM rejection with the IF DSP; high-quality and super stable final amplifier utilizing the new push-pull MOSFET RD70HUP2; aluminum heat sink with 80mm low-noise axial flow cooling fan; high-speed automatic antenna tuner with a large capacity 100-channel memory; RF and AF transmit monitor; microphone amplifier with three-stage parametric equalizer (SSB/AM mode); band stack function; and more, including:

- Narrow Band SDR with three types of roofing filters and phenomenal multi-signal receiving characteristics
- RMDR reaches 116 dB or more; the close-in BDR reaches 141 dB or more; and 3rd IMDR reaches 109 dB or more in the 14 MHz band at 2 kHz separation
- 250 MHz High Resolution Direct Digital Synthesizer delivers quiet and clear reception
- 3-Dimensional Spectrum Stream on the five-inch full-color TFT display with touch-panel functionality
- Front panel designed for superior operating efficiency, including multipurpose VFO outer dial—a large multipurpose ring around the outside of the VFO dial that enables additional controls and recall of memory channels
- External Display DVI Output on FTDX10 rear panel supports dedicated external flat panel Monitor Screen
- Remote operation with optional SCU-LAN10 unit and network remote control software

For many more details, enter "FTDX10" at DXEngineering.com

YSU-FTDX-10	Yaesu HF/50 MHz 100W SDR Transceiver	CALL/WEB
YSU-SP-30	Desktop External Speaker for the FTDX10	\$179.99
YSU-XF-130CN	Internal Plug-In Narrow CW Roofing Filter, 300 Hz	\$199.99
YSU-M-70	Desktop Microphone	\$144.95

Universal Wire Stand

Don't risk sliding your expensive portable/base radio onto the floor. If your radio has a folding wire loop-style stand, this stand will keep it secure. The stand features four anti-skid feet and three different cradle positions to hold your radio at the optimal viewing angle. It's compatible with the Icom IC-7300, IC-718, Elecraft K3, Yaesu FT-991, Alinco SR8T and many more.

NIF-DS-WB-UNIV	Universal Wire Stand	\$23.95
----------------	----------------------------	---------



YAESU

FT-991A HF/VHF/UHF Multi-Mode Transceiver

Ideal as an all-band base station radio, Yaesu's FT-991A delivers 160M-70cm coverage with multi-mode operation, including CW, AM, FM, SSB and Digital Modes like Packet, PSK-31, RTTY and C4FM. Updated from the original FT-991, the FT-991A includes a new real-time spectrum scope and a multi-color waterfall display.

This radio features an advanced balanced receiver circuit configuration and cutting-edge DSP to deliver excellent interference rejection in real-world operating conditions. The selectable roofing filters help mitigate interference.

The FT-991A packs 100 watts of output power (50 watts on VHF), and has a built-in automatic antenna tuner that will memorize its tuning data to make band switching a laser-fast process. This rugged and compact radio is at home in a base station or when paired with Yaesu's ATAS antenna, it makes an excellent portable radio.

YSU-FT-991A	HF/VHF/UHF Multi-Mode Transceiver	CALL/WEB
YSU-MMB-90	Mobile Mounting Bracket	\$49.99
YSU-ATAS-25	Micro Manually Tuned Portable Antenna	\$249.99



YAESU

SCU-LAN10 Network Remote Control System

Don't miss the chance to log a coveted DXCC entity while you're away from your shack! Why not make your standout Yaesu rig available to fellow club members? It's all possible with the SCU-LAN10 Network Remote Control System. This compact and powerful interface brings the advanced functionality of Ethernet LAN port direct remote control to your Yaesu FTDX-101D, FTDX-101MP and FTDX10 transceivers. Using free PC software, you can access and control these radios on your PC, local network or via the Internet from anywhere in the world with the SCU-LAN10 interface. In addition to basic transceiver operations, a variety of scope displays, including a dual-band scope, and other fulfilling functions make it possible to enjoy the advantages of your hybrid SDR from a remote location. The SCU-LAN10 includes a special 13-pin DIN interface cable, a USB cable and two snap-on ferrite RFI suppressors.

YSU-SCU-LAN10	Network Remote Control System, Yaesu FTDX-101 Series, FTDX10	\$319.99
---------------	--	----------



Need advice? 1-330-572-3200 or DXEngineering@DXEngineering.com

YAESU

FT-710 AESS HF/50 MHz Base/Portable Transceiver

Yaesu's 160 through 6 meter FT-710 AESS Transceiver with SP-40 Speaker features advanced hybrid-SDR circuitry that achieves industry- and class-leading receive performance in a compact design that makes it perfect for portable ops as well as base station service. It's loaded with the good stuff, including AESS (Acoustic Enhancement Speaker System)—a welcome addition for a transceiver of this size (9.4" W x 3.1" H x 9.7" D). The AESS' mid-low frequency enhancement speaker and the side speaker combine to create dramatic high-fidelity audio output. The result is an expansive and clear receive audio from a rig weighing just under ten pounds. Other features include 5 to 100 watts CW/SSB; 5 to 25 watts AM; 4.3" high-resolution TFT color multifunction touchscreen display; intuitive management of settings and functions; easy navigation thanks to an ergonomically designed front panel and large control dials; real-time spectrum scope display that employs the FTDX series SDR 3D scope 3-Dimensional Spectrum Stream to visualize changes in signal strengths within the bands; multi-signal receiving characteristics enabled by powerful front-end and a low-noise oscillator system; QRM rejection with all interference functions (high-speed DSP) accessible from the DSP dial; quick Memory Bank stores dedicated memory channels that are easily recalled with the touch of a button; and up to 10 memory channels. You also receive:

- Preset mode functions, most suitable for FT8 operation, are available with up to five preset parameters
- Built-in high-speed automatic antenna tuner with 100 channel memory (support for connecting an FC-40 Remote Auto Antenna Tuner is supplied on the back panel)
- CW operation with CW Zero-In Display, CW Auto Zero-In, CW Reverse, CW Keying Signal Form Shaping, and Contest Memory Keyer
- SD memory card slot for recording and saving transceiver settings, memory contents, and screen capture images, as well as for updating firmware

The Yaesu FT-710 AESS comes with SSM-75E Hand Microphone, SP-40 External Speaker, DC power cable w/fuse, and spare fuse.

Enter "FT-710" at DXEngineering.com for more details.

YSU-FT-710-AESS	FT-710 AESS HF/50 Base/Portable Transceiver.....	CALL/WEB
YSU-SMB-209	Mobile Bracket for FT-710/FT-710 AESS	\$38.00
YSU-MHG-1	Carrying Handle for FT-710 AESS, FTDX10, FT-450D	\$14.99



YAESU

FT-710-FIELD HF/50 MHz Base/Portable Transceiver

The high-performance Yaesu FT-710 transceiver, with advanced SDR circuitry that accomplishes industry-leading receive performance, is now available in a portable-friendly version. A carry strap kit is included for convenient transport. The FT-710-FIELD saves weight and space by excluding the SP-40 speaker, an available option if you want to take advantage of Yaesu's Acoustic Enhanced Speaker System (AESS) in the field, too. This compact rig (9.4" W x 3.1" H x 9.7" D) has all the great features and benefits of the FT-710-AESS (see left), including 100W CW/SSB, large control dials and ergonomically designed front-panel layout for easy navigation, real-time spectrum scope display, high-speed DSP for effective QRM rejection, built-in high-speed automatic antenna tuner, CW operation with CW zero-in display, and much more. Enter "710-Field" at DXEngineering.com for more details.

YSU-FT-710-FIELD	FT-710 w/Carry Strap, w/o SP-40 Speaker ...	CALL/WEB
YSU-SP-40	External Desktop Speaker	\$149.99



New!



Nifty!

Desk Stands

These stands from Nifty have a heavy steel base to keep your radio and its front panel safe and secure on your desktop. The proper stand will also position the controls right where you want them. The HT stand's shelf is adjustable to fit most handhelds with a belt clip. Nifty also has several model-specific stands, see list below.



NIF-HT-STAND	HT Radio Desk Stand	\$43.95
NIF-ID-5100STAND	Stand for Icom ID-5100	\$33.95
NIF-DS-IC-705	Stand for Icom IC-705 and IC-905	\$33.95
NIF-DS-FTM-300DR	Stand for Yaesu FTM-200DR/300DR/DE	\$33.95
NIF-FTM400DRSTAN	Stand for Yaesu FTM-400DR and FTM-400XD	\$33.95
NIF-DS-KX3	Stand for Elecraft KX3	\$33.95

NIF-HT-Stand

YAESU

Accessory	Part Number	Description	YSU-FT-710	YSU-FT-991A	YSU-FTDX10	YSU-FTDX-101D/MP
Antenna	YSU-ATAS-120A	40M-70cm Auto Active Tuning Mobile Antenna	x	x	x	
Base Kit	YSU-ATBK-100	VHF/UHF Antenna Base Kit	x	x	x	
Microphone	YSU-MH-36E8J	Hand Mic, DTMF		x		
Cable	YSU-CT-39A	Packet Cable, 6-Pin DIN to Stripped Leads	x	x	x	
Keypad	YSU-FH-2	Remote Control Keypad	x	x	x	x

Nifty!

Reference Guides Base Transceivers

Sometimes the hardest part of using a radio is reading the lengthy instruction manual. Nifty created concise Reference Guides for specific radio models, written in easy-to-follow language. They're spiral bound and laminated so they won't get ruined in a drawer, EMCOMM Go-Kit or glove box. Choose your manual from the radios below. If yours isn't listed, there are many more available at DXEngineering.com.



Part Number	Brand	Model	Price
NIF-MM-IC7100	Icom	IC-7100	\$38.95
NIF-MM-IC718	Icom	IC-718	\$21.95
NIF-MM-IC7300	Icom	IC-7300	\$29.95
NIF-MM-IC7610	Icom	IC-7610	\$31.95
NIF-MM-IC9700	Icom	IC-9700	\$35.95
NIF-MM-TS590SG	Kenwood	TS-590SG	\$28.95
NIF-MM-TS890S	Kenwood	TS-890S	\$35.95
NIF-MM-FT710	Yaesu	FT-710	\$29.95
NIF-MM-FT991A	Yaesu	FT-991A	\$31.95
NIF-MM-FTDX10	Yaesu	FT-DX10	\$29.95
NIF-MM-FTDX101D	Yaesu	FTDX-101D/MP	\$29.95
NIF-MM-FTDX1200	Yaesu	FTDX-1200	\$31.95

Equipment Covers

You've spent a lot of money on your Ham Radio gear, so protect it with EAntenna's high-quality Equipment Covers. These custom-fit covers are embroidered with the logo and model number of the gear they're protecting. Each polyester/cotton cover has slits in the back, so you can slip it over the radio or amp without unplugging any cables.



Part Number	Description	Price
EAN-FIC7300	Icom IC-7300	\$46.99
EAN-FIC7610	Icom IC-7610	\$46.99
EAN-FIC7851	Icom IC-7851	\$48.99
EAN-FICR8600	Icom IC-R8600	\$46.99
EAN-FIC9700	Icom IC-9700	\$46.99
EAN-FTS590	Kenwood TS-590	\$46.99
EAN-FTS990	Kenwood TS-990	\$49.99
EAN-FTS890S	Kenwood TS-890S	\$49.99
EAN-FT991	Yaesu FT-991	\$44.99
WMO-DC-FTDX10	Yaesu FTDX10	\$46.99
WMO-DC-FT710	Yaesu FT-710	\$46.99
EAN-FFTDX101-MP	Yaesu FT-DX101-MP	\$46.99
EAN-FFTDX101-D	Yaesu FT-DX101-D	\$46.99



EAN-FIC7300



Transceiver Lifting Handles

Say you want to hoist your expensive transceiver from where it sits horizontally on the desk and position it vertically without risking damage to sensitive components and rear panel connectors. Not an easy—or prudent—proposition. Now there's a convenient way to do it safely. WiMo has produced handles that can be mounted on popular transceivers so lifting and gently setting down your rig "face up" is worry-free. Angled handles flair out slightly for better grip. Straight handles allow users to mount equipment side-by-side with the transceiver. Mounting screws and black adhesive tape included.



WMO-IC7300-ANGL

WMO-IC7300-ANGL	Angled Handles for Icom IC-7300/IC-9700/IC-R8600	\$55.99
WMO-IC7300-STR8	Straight Handles for Icom IC-7300/IC-9700/IC-R8600	\$55.99
WMO-FT991A-ANGL	Angled Handles for Yaesu FT-991A	\$57.99
WMO-IC7610-ANGL	Angled Handles for Icom IC-7610/IC-7600	\$99.99

We're All Elmers Here! Get Expert Support at: Elmer@DXEngineering.com



IC-2730A VHF/UHF FM Transceiver

Icom's IC-2730A is a full-feature 50 watt dual-bander with a built-in duplexer, so you can use a single dual-band antenna to operate on both 2M and 70cm. The radio also boasts simultaneous VHF/VHF, UHF/UHF and VHF/UHF receive capabilities and 2 external speaker outputs. It uses CTCSS/DTCS tones for quiet stand by and repeater access. That makes this radio easy to use as a mobile or base station. Air band and weather band (with WX alert) coverage adds to the IC-2730A's versatility.

- Cross band repeater capability
- Free programming software
- Sub band auto mute function
- Auto repeater function
- Large, easy-to-read display with intuitive controls

This radio comes with a remote control microphone, a controller cable, a mic hanger and DC power cable.

ICO-IC-2730A	VHF/UHF FM Transceiver.....	CALL/WEB
ICO-MB-2730B	Mobile Transceiver Mounting Control Head Attachment Bracket, Includes MBA-4 and MBF-4.....	\$87.99
ICO-MB-2730R	Mobile Transceiver Mounting Control Head Attachment Bracket, Includes MBA-5 and MBF-4.....	\$68.99
ICO-MB-2730R1	Mobile Transceiver Mounting Control Head Attachment Bracket, Includes MBA-5, MBF-1, and MBF-4.....	\$159.99
ICO-MBA-4	Control Head Reattachment Bracket, for IC-2730A.....	\$55.99
ICO-MBA-5	Suction Cup Mounting Base.....	\$39.99



ID-5100A-D Digital Transceiver

Icom's cutting-edge ID-5100A-D Digital Transceiver has been a popular rig since the day it was launched. It features a large touchscreen LCD, optional Bluetooth® connectivity and second station control through an Android device.



The ID-5100A is a 50 watt D-STAR 2M/70cm mobile radio with a built-in GPS device, along with a CTCSS/DTCS encoder and decoder. The radio uses Icom's Dualwatch technology, and includes independent VHF/UHF band units, a built-in GPS engine and 1,000 memory channels. New deluxe model includes MBA-2 control bracket.

To add Bluetooth functionality to the Icom ID-5100, install the optional Plug-In Module.

It works with the special Icom VS-3 headset to let you link your radio with Bluetooth enabled devices (like a car's infotainment system). This is a particularly handy feature if you live in a state that requires hands-free mobile communication.

The headset has a TX/RX switch, a PTT switch, plus three programmable buttons. A USB charging cable is included.

ICO-ID-5100A-D	D-STAR Deluxe 2M/70cm Digital Transceiver.....	CALL/WEB
NIF-ID-5100STAND	Stand for Icom ID-5100.....	\$33.95
ICO-MBA-2	Mounting Bracket.....	\$42.99
ICO-OPC-2218LU	PC Control Programming Cable, USB A Plug, to USB Mini, to Stereo 2.5mm Plug.....	\$65.99
ICO-OPC-1529R	PC Control Programming Cable, RS-232, Stereo 2.5mm Male Plug.....	\$42.99



Lido Mounts for IC-705 and Other Equipment

Lido Mounts offers a wide array of mobile mounting options for hands-free devices, receivers, microphones, and more. We've listed a few of the latest options here, including the L-MAX-AMP Heavy-Duty Seat Bolt Mount, which is compatible via direct connection or remote head bracket with devices having a 4-hole AMPs pattern mounting plate or bracket (IC-705, ID-5100, TM-D710, FT-7800, cameras, GPS devices, satellite radios, and more). The LM-802-705 Cup Holder Mount for IC-705 and IC-7100 is made to swivel into just about any position you desire. The LM-803EXP Cup Holder Mount comes with Lido's EXP-2 Express Plate that can accommodate the belt clip on any portable radio. The cup holder mount height can be adjusted from 6 1/2" to 8".



Enter "Lido" at DXEngineering.com for more details and the full lineup.

LDO-L-MAX-AMP	Heavy-Duty Seat Bolt Mount for IC-705, et. al.	\$89.95
LDO-LM-802-705	Cup Holder Mount for IC-705/IC-7100	\$49.95
LDO-LM-803EXP	Cup Holder Mount	\$24.99
LDO-LM105EXT-2-6	Remote Head Unit Vent Mount Bracket, IC-2730, ID-5100	\$24.95

Visit DXEngineering.com for the latest limited-time offers and special savings!



IC-705 HF/VHF/UHF D-STAR All Mode Portable Transceiver

Join the growing legions of Hams who are having a blast with Icom's latest standout rig, which boasts the features of the IC-7300, IC-7610 and IC-9700 in a portable QRP package small enough to hold in one hand (7.9" W x 3.1" H x 3.3" D) and fit inside a backpack for portable fun or EMCOMM operating. Features include:

- SDR Direct Sampling technology for low noise and low distortion receiver performance and impressive transmission capabilities
- 4.3" color touch screen display—same as used in the IC-7300 and IC-9700—and high-speed, high-resolution spectrum scope and waterfall display in real time
- All-band, all-mode capability: 160-6m+2m+70cm; SSB/CW/RTTY/AM/FM/DV (D-STAR)
- 10W output power on external 13.8V supply or 5W with included clip-in rear panel battery pack (BP-272 Li-Ion)
- Built-in Bluetooth and wireless LAN
- Built-in GPS tracking logger and repeater locator
- Fully equipped for D-STAR functions
- Provided whip antenna for VHF/UHF, speaker microphone, and DC power cable

Billed by Icom as "Your New Partner for Field Operations," the IC-705 is designed to fit in an optional backpack (LC-192), featuring holes for antenna, as well as coaxial and microphone cables. See IC-705 accessories below.

ICO-IC-705	IC-705 HF/VHF/UHF D-STAR All Mode Portable Transceiver.....	CALL/WEB
ICO-AH-705	Icom HF/6M Automatic Antenna Tuner.....	\$379.99
ICO-AL-705	Icom 40M-10M Magnetic Loop Antenna.....	\$319.99
ICO-BP-307	Icom 3150 mAh Li-Ion Battery	\$139.99
ICO-CP-25H	Charger Cable, Cigarette Lighter Adapter	\$33.99
ICO-HM-243	Icom IC-705 Speaker Microphone	\$86.99
ICO-LC-192	Icom IC-705 Backpack	\$179.99
ICO-OPC-2421	Icom IC-705 DC Power Cable	\$38.99
ICO-MBF-705	Icom IC-705 Desktop Tray	\$48.99
WMO-BASE-705	WiMo Desktop Stand	\$59.99
WMO-MBA-705	WiMo Antenna Holder and Table Stand.....	\$74.99
NIF-DS-IC-705	Nifty Desk Stand	\$33.95
MTU-MAT-705PLUS	mAT TUNER IC-705 Automatic Antenna Tuner, 1.8-54 MHz.....	\$229.95
MTU-MAT-RC1	Coaxial Cable Assembly for MAT-705PLUS	\$10.00
DMV-Y-ADAPT-3	Y-Adapter Separator Cable for IC-705, 5.9'	\$5.99

HF/6M Automatic Antenna Tuner

Icom's AH-705 Automatic Antenna Tuner (1.8 MHz to 50 MHz) delivers simple and effective tuning with just the push of the Tuner button on the IC-705 transceiver. Featuring maximum 10W input power, quick tuning times, P54 dust-protection, and water-resistant construction, the AH-705 makes an excellent addition to this portable rig.



ICO-AH-705	Icom HF/6M Automatic Antenna Tuner	\$379.99
ICO-OPC-2474	Optional Control Cable, 16.4'	\$42.99
ICO-OPC-2475	Optional Coaxial Cable, 16.4'	\$79.99

ICOM			ICO-IC-2300H	ICO-IC-2730A	ICO-ID-5100A-D	ICO-ID-4100A
Accessory	Part Number	Description				
Bracket	ICO-MBF-1	Switch Mount for Control Head		x	x	x
	ICO-OPC-1132	Power Cable, DX, T-Style 2-Pin, 9.8'	x			
	ICO-OPC-1156	Remote Separation Cable, 11.5'		x	x	x
Cables	ICO-OPC-478UC	PC to Radio Programming Cable, USB	x	x	x	x
	ICO-OPC-589	Microphone Adapter Cable, 8-Pin Modular Plug to 8-Pin Round Receptacle	x	x	x	
Mount Bracket	ICO-MBF-4	Mobile Transceiver Mounting Bracket		x	x	x
Bluetooth® Headsets	ICO-VS-3	Bluetooth Headset		x	x	x
	ICO-UT-133	Bluetooth Plug-in Module		x	x	

YAESU

FTM-300DR C4FM/FM Dual-Band Digital Mobile Transceiver

While this rig includes many popular features and benefits found on the FTM-100DR and FTM-400DR/XDR series radios, that's only the tip of the iceberg when it comes to this versatile unit. Right off the bat you'll notice the 300DR's smaller profile than the FTM-400DR, which makes it a good choice for mounting in your vehicle or packing in an emergency Go-Kit.

The two-inch, high-resolution QVGA full-color TFT display is designed for superb visibility and easy reading. Its high brightness and wide viewing angle clearly highlight the frequency, operation bands, and the high-speed, high-resolution band scope function, allowing users to monitor more than 60 channels centered on the current VFO frequency in real time. Other features include:

- 50W stable high-power output
- Clear, crisp audio provided by the 3W audio power speaker
- Built-in Bluetooth® unit which enables hands-free operation
- Dual-band operation (V+V, U+U, V+U, U+V) and dual/simultaneous C4FM monitoring for both A and B bands
- Full duplex—a huge perk for contacting Amateur Radio satellites
- Crossband repeater operation with abilities of AMS-In (Fixed FM out only)
- E20-11 (Easy to Use Operation) function: This upgrade makes it simpler to access commonly used functions such as changing signaling. A menu of frequently-used functions can be called up with a single touch.
- MAG (Memory Auto Group) function
- MCS (Multi-Channel Standby) function: One-touch operation allows operators to put multiple memory channels in a standby state
- Dual functions for recording both transmitted and received audio
- Included new SSM-85D Microphone with Dual Tone Multi-Frequency
- Large-capacity 1,104 channel memory

For many more details, enter "FTM-300DR" at DXEngineering.com.

YSU-FTM-300DR C4FM/FM Dual-Band Digital Mobile Transceiver **CALL/WEB**



YAESU

FTM-200DR 50W C4FM-FM Dual Band Digital Transceiver

Another outstanding addition to the Yaesu mobile transceiver lineup, this single-receiver 144-148 MHz and 430-450 MHz radio delivers a reliable 50 watts of transmit performance with a heavy-duty heat sink that features a Funnel Air Convection Conductor to keep everything cool. The rig's 2" high-resolution QVGA full-color TFT display provides high visibility while highlighting the frequency of the operating band. Its speaker delivers a clear and crisp 3 watts of receive audio specifically tuned for radio communications, and its detachable front panel provides users with many mounting options. The FTM-200DR supports optional Bluetooth wireless operation using the SSM-BT10 headset or other commercially available Bluetooth headsets with the optional BU-4 Bluetooth Adapter Unit (sold separately). Also take advantage of the transceiver's many C4FM communication features (Automatic Mode Select, Smart Navigation Functions, Worldwide WIRE-X Internet, et. al.), high-speed band scope, 66-channel GPS receiver, and much more. Enter "FTM-200DR" at DXEngineering.com.

YSU-FTM-200DR FTM-200DR 2M/70cm Digital Transceiver **CALL/WEB**



YAESU

FTM-500DR Dual-Band Mobile Transceiver

Billed by Yaesu as a "Bighead" rig, this 50W, C4FM/FM, 144/430MHz transceiver features uncomplicated and intuitive mobile operation with a 2.4-inch high-resolution full-color touch-panel display, large VFO knob, and demountable front panel control head. Upgraded clear and powerful audio is provided by its Acoustic Enhancement Speaker System, first featured on the FT-710 AESS HF/50 MHz model. This dual speaker system produces high-fidelity audio generated by digital processing. Enjoy superior sound delivered by the front panel 6W and the main unit internal 3W speakers. Not a basic replacement for the FTM-400DR, this remarkable mobile includes an array of new features including True Dual Band C4FM/C4FM Digital D-D Dual Receive, Advanced C4FM Digital Mode and analog FM with AMS (Automatic Mode Select), high-speed band scope, "Touch & Go" functionality, enabling quick VFO changes by touching the target frequency on the display, and "Search & Go" dual-receive to monitor a second frequency during main channel operation, Bluetooth® headset capability, air band RX, built-in GPS, and APRS®. Choose from an array of accessories, including the Swing-Head Kit (YSU-SJMK-500), which lets you mount the front panel for easier viewing and use. Enter "FTM-500DR" at DXEngineering.com for more details.

- YSU-FTM-500DR FTM-500DR Dual-Band Mobile Transceiver **CALL/WEB**
- YSU-SJMK-500 Swing-Head Kit **\$29.99**
- YSU-MMB-103 Dash-Mount Bracket Kit for Control Head **\$9.99**
- YSU-CT-132 Control Head Separation Cable, 20' **\$44.99**
- YSU-SCU-62 Control Head Extension Cable, 10' **\$29.99**
- LDO-LM-105-QR Lido Hook-Style Vent Mount Kit **\$19.95**



YAESU

Part Number	Description	YSU-FTM-200DR	YSU-FTM-300DR	YSU-FTM-500DR	YSU-FTM-600DR
YSU-SSM-85D	DTMF Hand Microphone	x	x	x	x
YSU-SSM-BT20	Bluetooth Headset	x	x	x	x
YSU-SCU-41	Charging Cable for SSM-BT10 Bluetooth Headset	x	x	x	x
YSU-MEK-5	Microphone Extension Kit	x	x	x	x
YSU-BU-4	Plug-In Bluetooth Adapter Unit	x			x
NIF-DS-FTM-300DR	Desk Stand	x	x		
YSU-MMB-98	Suction Cup Mounting Bracket	x	x		x
YSU-SCU-58	Wires-X Connection Cable	x	x	x	
YSU-CT-164	Data Cable, 10-Pin Mini-DIN to 6-Pin Mini-DIN	x	x		x

ICOM IC-V3500 VHF/FM Mobile Transceiver

If you're looking for a rugged and easy-to-operate 2M/VHF rig, Icom's IC-V3500 was made with you in mind. It features a white, well-designed backlit LCD for enhanced readability and reduced eyestrain. The IC-V3500 transmits from 144-148 MHz at a full 65W of stable output power and receives from 136-174 MHz. Other perks include instant mute; loud, crisp speaker output with Audio Volume Boost; and new emergency safety functions. HM-133V hand microphone with keypad and DC power cable included.

- ICO-IC-V3500 IC-V3500 VHF/FM Mobile Transceiver **CALL/WEB**
- ICO-HM-154 PTT Mobile Hand Mic, UP/DOWN Buttons Only **\$49.99**
- ICO-OPC-440 Mic Extension Cable, 8-Pin Modular, RJ45 **\$86.99**
- ICO-OPC-589 Mic Adapter Cable, 8-Pin Modular to 8-Pin Round **\$39.99**



YAESU

WiRES High Performance Digital and Analog Internet Linking Interface

This interface transforms RF communications to VoIP format, enabling long distance digital contact. WiRES is compatible with C4FM digital stations, plus traditional analog FM operation. You simply plug in to any Yaesu radio on the network and go without need for complicated router settings. It comes with all cables and set-up software. Read more about this system at DXEngineering.com.

YSU-HRI-200 WiRES High Performance Digital/Analog Linking Interface. **\$124.99**



Lido

Bracket for Yaesu Mobile Radios

Made from lightweight, strong aluminum, this bracket is designed to adapt a required Pro-Clip mount or vehicle-specific mount (not included) for direct 5mm swivel stud attachment to Yaesu FTM-100, FTM-300, FTM-350, FTM-400 or FT-891 control heads. This mount can be attached to any Pro-Clip or other VSM mount with a 4-hole AMPS pattern and includes a double-T quick-release mounting system with the swivel. A mounting plate for the microphone is also included. The LMEXT01DELUX Extension Bracket allows you to mount two devices to one vehicle mount. Measuring 4 3/4" x 2 1/4", the bracket also lets you adjust device location for extra horizontal or vertical clearance.

- LDO-LM-EXT-10 Bracket for Yaesu Mobile Radios **\$29.95**
- LDO-LMEXT01DELUX Extension Bracket **\$29.95**



Prices are subject to change without notice.

YAESU

FT-891 HF/6M All Mode Portable Transceiver

Portable and mobile operators rejoice! The all-new FT-891 gives you HF and 6 meter coverage plus 100 watts of transmit power. A high speed 32 bit DSP successfully mitigates QRM, and the FT-891's circuit design and 3 Khz roofing filter boasts Yaesu's legendary performance. The large screen and intuitive controls make the radio easy to operate. The FT-891 is rugged and compact, with a detachable faceplate for use in the field or in a vehicle.

YSU-FT-891 HF/6M All Mode Portable Transceiver **CALL/WEB**



YAESU

FT-2980R 80W 2M FM Mobile Transceiver

This rugged, compact and economical radio is ideal for mobile or portable stations. At 80 watts, the new FT-2980R adds extra transmit power over the venerable 75W FT-2900R. Even at those output levels, the radio requires no fan—robust heat sinks easily handle the power. Three watts of audio output make it easy to hear in noisy environments too.

An intuitive smart scan function means it's simple to find activity, while the alphanumeric display has four brightness levels for use in a mobile station. In addition to the extended 136-174 MHz receive range, this mobile radio gets the NOAA weather channels with severe weather alerts. It's also equipped with Yaesu's handy dual watch feature, which allows you to operate on a VFO, Memory channel, or Home channel, while periodically checking a user-defined Memory Channel for activity.

YSU-FT-2980R 80W 2M FM Mobile Transceiver..... **CALL/WEB**



ALINCO DR-06TA VHF FM Transceiver

The upgraded DR-06TA builds upon Alinco's legendary series of mobile radios. It's loaded with features that you don't often find in this price range.

- 100 memory channels
- Theft alarm feature
- Ten autodial memories
- 7 character alphanumeric display
- Wide and narrow FM modes
- CTCSS, DCS encode and decode, DTMF encode and tone-burst

The 6M DR-06TA features 50 watts of output. Its optional EJ-41U TNC board permits 1200/9600 bps digital packet operation. The DR-06TA also has a handy front panel data port and rear panel DSUB9 computer connection. The radio comes with Alinco's commercial-grade backlit microphone with a metal connector.

ALO-DR-06TA 6M VHF FM Transceiver **CALL/WEB**



YAESU

Yaesu FTM-6000R 50W 144/430 MHz Dual-Band FM Mobile Transceiver

If you're in the market for a basic mobile rig that doesn't skip on many of the latest functions that amateur operators demand in their transceivers, get your hands on the Yaesu FTM-6000R. Here is just some of what you'll find packed into this dual-band radio, which can be made Bluetooth-capable with the Yaesu BU-4 plug-in module:

- Brand-new user-intuitive operating interface (E2O-III). The interface has three modes for users to assign functions and settings.
- 50 watts of stable and reliable transmit performance
- Heavy-duty heat sink equipped with Funnel Air-Convection Conductor
- Speaker delivers 3 watts of crisp receive audio tuned for radio communication
- 1,100 memory channels with alphanumeric tags
- Detachable front panel that can be mounted at the most desirable position
- Supports optional Bluetooth wireless operation using the SSM-BT10 Headset or a commercially available Bluetooth headset. Installation of the BU-4 Bluetooth Adapter Unit is required.
- Scanning functions include VFO, Memory, and Primary Memory Group Scan
- New Band Skip function permits unused bands to be skipped while the registry memory channels can be called, even if the frequency is in the skipped band

FTM-6000R supplied accessories:

- DTMF Microphone SSM-85D
- Bracket for Control-Head
- DC Power Cable
- Mounting Bracket
- Control Cable (10') & USB Cable
- Operating Manual

Enter "FTM-6000R" at DXEngineering.com for more details.

YSU-FTM-6000R FTM-6000R Mobile Transceiver **CALL/WEB**



ALINCO

DR-CS25T 50W 222-225 MHz Compact Mobile Transceiver

Enjoy smooth operation, large back-lit display and back-lit microphone keys, excellent transmit/receive audio, and plenty of high-tech features in the ultra-compact DR-CS25T VHF mobile transceiver from Alinco. Take advantage of the rig's 200 PC-programmable channels; selectable output power of 50/25/10W; variety of built-in calling features: 2-Tone/5-Tone, 51 CTCSS, 1024 DCS, 4 Tone-burst tones and DTMF/ANI decode; EMS-74 DTMF microphone that enables direct frequency entry and remote control; various scan modes; and more. Also comes with mounting bracket with hardware kit and DC power cable.

ALO-DR-CS25T 222-225 MHz Compact Mobile Transceiver..... **CALL/WEB**



YAESU

FTM-3100R 2 Meter Mobile Transceiver

The compact, durable, and easy-to-operate FTM-3100R is a ruggedly built VHF-FM mobile transceiver, providing high output power of up to 65 watts to ensure stable long-distance communications. One of the distinguishing features of this exciting mobile transceiver is the Front Panel Speaker that delivers 3 watts of loud and crystal clear audio. The transceiver is a great choice for stress-free and enjoyable communications, even in noisy environments.

This rig comes equipped with a heavy-duty heat sink that includes a FACC, Funnel Air-Convection Conductor (Wind Tunnel). The FACC gathers cool air through a wide open front air intake and concentrates the air flow to the critical final amplifier area drawn by a rear cooling fan. Enjoy 220 memory channels with 8 alpha-numeric tags consisting of 199 "Regular" memories, one "Home" channel for a favorite frequency or repeater pair, and 10 sets of band-edge memories. This analog FM transceiver boasts all of the features of the FTM-3200R, except C4FM Digital mode.

YSU-FTM-3100R 2M FM Analog Mobile Transceiver..... **CALL/WEB**



YAESU

Accessories for Yaesu FT-817/818 Mobile Transceivers

DX Engineering carries a nice selection of accessories for the FT-817 and FT-818, including the LDG Automatic Antenna Tuner, SOTABeams Digital Audio Filter Module, MFJ Portable Telescopic HF Antenna, Yaesu Handheld Microphones, mAT TUNER MAT-10 Automatic Antenna Tuner, Nifty Mini Manuals, DC Adapters and Cables, Chelegance Tilt Stand Bracket Kit, bhi RADIO-MATE Keypad, Yaesu Soft Carrying Case, Ameritron Interface Cables and more. Enter "FT-817/818" at DXEngineering.com.

Mini-Manuals and Quick Reference Cards for Mobile Radios

Due to their size, mobile transceivers often incorporate a lot of menus and very few physical controls, which means there's always a bit of a learning curve if you're looking at a new radio. Nifty Mini-Manuals and Quick Reference Cards ensure that you'll get up to speed quickly.

Part Number	Brand	Model	Price
Mini-Manuals			
NIF-MM-IC2730	Icom	IC-2730A	\$21.95
NIF-MM-IC705	Icom	IC-705	\$33.95
NIF-MM-ID5100	Icom	ID-5100A	\$36.95
NIF-MM-TMD710G	Kenwood	TM-D710G	\$31.95
NIF-MM-TMV71A-E	Kenwood	TM-V71A/E	\$24.95
NIF-MM-FTM-200DR	Yaesu	FTM-200DR	\$31.95
NIF-MM-FTM300DR	Yaesu	FTM-300DR	\$35.95
NIF-MM-FTM500DR	Yaesu	FTM-500DR	\$35.95
NIF-MM-FTM400XDR	Yaesu	FTM-400XDR	\$35.95
NIF-MM-FTM-6000R	Yaesu	FTM-6000R	\$21.95
NIF-MM-FTM7250DR	Yaesu	FTM-7250DR	\$24.95
NIF-MM-FT2900R	Yaesu	FT-2900R	\$21.95
NIF-MM-FT70DR	Yaesu	FT-70DR	\$24.95
NIF-MM-FT817ND	Yaesu	FT-817/ND	\$21.95
NIF-MM-FT857D	Yaesu	FT-857/D	\$21.95
NIF-MM-FT8900R	Yaesu	FT-8900R	\$21.95
NIF-MM-FT891	Yaesu	FT-891	\$28.95

Nifty!



NIF-MM-IC705

Our catalog is only the beginning! See thousands of products at DXEngineering.com

ALINCO

DR-MD500T Advanced Dual-Band VHF/UHF DMR Part 90 Mobile Transceiver

Another stellar rig in Alinco's mobile radio lineup, the DR-MD500T is loaded with features and benefits that make this a great addition to any transceiver collection. Capable of operating in digital and analog mixed modes in VFO or memory mode, this DMR Tier I and II rig features large 1.77" color LCD display; crystal clear DMR digital audio for use in noisy environments; 2W audio output to ensure loud, crisp receive audio; 55W output power on VHF and 40W on UHF; up to 4,000 memory channels; 10,000 TalkGroups and up to a 300,000 contact list; automatic repeater roaming; X-band repeat, analog uplink/digital downlink or vice versa; communication recording in digital mode; and much more. The radio comes with EMS-88 handheld DTMF keypad microphone, mobile bracket, mounting bracket kit, mic hanger, DC cable, and USB data cable. **What do hams say? Five Stars: "This gem has 300,000 contacts memory so you can load every DMR ID in the world today with 30% more room to spare...The sound quality is great...The radio is compact, has a cooling fan and tons of features including an FM radio."**



ALO-DR-MD500T VHF/UHF DMR Part 90 Mobile Transceiver **CALL/WEB**

DR-735T 2M/70cm Mobile Transceiver

This versatile new radio from Alinco supports full duplex for true dual-band functionality and cross-band repeat. The DR-735 packs a wide range of adjustable parameters, from RF output to LCD screen color. The detachable controller allows for easy installation, while the heavy-duty base unit features plenty of integrated heat sinks for stability and long-term durability. It also boasts wide and narrow ceramic filters for narrow band operation. Find up-to-date specs at DXEngineering.com.



ALO-DR-735T 2M/70cm Mobile Transceiver **CALL/WEB**
 ALO-EDS-30 Front Control Unit Separation Cable Kit **\$54.99**
 ALO-EDS-8 Microphone Adapter for EMS-14 Desk Mic **\$29.99**

AnyTone

AT-D578UV III Plus Tri-Band VHF/UHF/DMR Mobile Transceiver

This well-built mobile transceiver comes loaded with ham-friendly benefits whether you're on the go or in the shack. It includes wideband full duplex receive capabilities (V+V,U+U&V+U), separate volume controls for channels A/B, built-in DMR repeater roaming, built-in Bluetooth connectivity for devices like the included Bluetooth PTT button, as well as the ability to pass Bluetooth audio through your vehicle's speakers. Features include selectable power outputs from 55W to 1W, color-customizable 1.77" color TFT display for easy day or night viewing, with selectable single or dual channel display; digital and analog APRS; transmit and receive GPS data location services for EMCOMM and other uses, such as coordinating hikers along a trail; 4,000 memories; 10,000 talk groups; up to 500,000 contact list entries; and built-in cross-band repeat. The AT-D578UV comes with mounting bracket and hardware, remote control hand microphone with keypad, USB programming cable and downloadable software, and DC power cable. **Enter "Anytone Tri-Band" at DXEngineering.com for more details.**



ANY-AT-D578UVIII Anytone VHF/UHF/DMR Mobile Transceiver **CALL/WEB**
 ANY-BT-01 Programmable Bluetooth Speaker Mic **\$149.99**

AnyTone

AT-D878UV II Plus Dual-Band DMR Handheld Transceiver

This rugged 2M/70cm rig includes DMR (Tier I/II) digital communications with support for traditional analog FM operation. Users can set frequency and transmit parameters without having to depend solely on preprogrammed channels, making the radio easier to use. Output power is easily configurable in four increments from 1-7 watts (2M) and 1-6 watts (70cm). It features a GPS receiver; up to 5 DMR IDs; roaming which allows you to select a reachable repeater from a predefined list; integrated Bluetooth and Bluetooth PTT; and RX and TX APRS on FM or DMR, with APRS setting accessible from the menu. The transceiver comes with antenna, Li-Ion battery, charger, AC adapter, belt clip, programming cable, and wrist strap.



ANY-AT-D878UVII AT-D878UV II Dual-Band DMR HT **CALL/WEB**
 ANY-BAT-868 AnyTone Battery Pack, Li-Ion, 3100 mAh, 7.4 V **\$29.99**
 ANY-BCS-200 Speaker Mic for AnyTone/Kenwood/Bridgecom/Other HTs **\$29.99**

ALINCO

DR-MD520T Advanced Tri-Band Mobile DMR Transceiver

This DMR Tier I and II tri-band transceiver (144/220/440MHz) from Alinco is loaded with features for today's serious operators, including 55W (VHF), 40W (UHF) maximum output power; 1.77" color LCD display; 4,000 memory channels; up to 500,000 digital contact lists; use of DVSI's AMBE+2 vocoder for crystal clear DMR digital audio for ham radio applications with no noise or fading, even in low-lying areas; built-in GPS receiver to support APRS; 2W audio output power to ensure loud and crisp receive audio; automatic repeater roaming; X-band repeat; analog uplink/digital downlink or vice versa; FM broadcasting receiver with 100 memory channels and VFO; 10,000 talk groups; AM aircraft bands receive capabilities; and much more. The DR-MD520T comes with EMS-88 hand microphone with built-in remote control keypad, mobile bracket, mounting bracket kit, DC cable, MicroUSB data cable, and mic hanger.



ALO-DR-MD520T Tri-Band Mobile Transceiver **CALL/WEB**

FireSpot DMR Hotspot

Here's an affordable and simple solution for operators who want to communicate worldwide with common digital radio modes such as D-STAR, DMR, Fusion and more. Housed in a sturdy 3D-printed case, the FireSpot comes with preinstalled host software and can be easily configured using the Pi-Star dashboard. The FireSpot can be used wirelessly or plugged directly into your router via Ethernet cable for a reliable and stable connection. Moonraker recommends that first-time setup is done via router plugged into the Ethernet port.



MKR-27-150 FireSpot DMR Hotspot **\$165.99**

SkyBridge Plus Dual-Band DMR Hotspot

The SkyBridge Plus is an Internet-based access point that allows you to use your DMR radio to communicate with other connected repeaters or hotspots through the Brandmeister network over the Internet, allowing you to talk all over the world. The fully assembled and tested unit supports operation on 2M and 70cm. Users can take advantage of its upgraded high-performance Pi3B board and processor; 400% faster boot-up speed; a larger, adjustable-brightness 2.4" LCD screen that allows more information to be displayed; wired and wireless 2.4 GHz Internet connection; and built-in Ethernet port. The device comes with WiFi antenna, Ethernet cable, and AC power adapter. Among its many benefits, you can easily scan and identify your Internet's IP address on screen without using an IP finding tool. SkyBridge Plus is compatible with DMR, D-STAR, Yaesu System Fusion, and NXDN radios. **Enter "SkyBridge" at DXEngineering.com for more details.**



BGM-SKYBRIDGEPLS SkyBridge Plus Dual-Band DMR Hotspot **\$424.99**

ALINCO

DJ-MD5XLT and DJ-MD5FXT VHF/UHF Dual-Band DMR Handheld Transceivers

The easy-to-use, 5 watt 2M/70cm DMR DJ-MD5XLT comes with built-in GPS along with APRS support and automatic repeater roaming. Other features include large full-color LCD display; 5/2.5/1.0/0.2W selectable output power; up to 4,000 memory channels; TDMA real two-slot DMR; FM Broadcast receive; built-in VOX; digital voice recorder; up to 500,000 digital contact lists; mixed mode capability; crystal clear DMR digital audio for use in noisy environments, security applications, or for repeater coverage areas, with no noise or fading, even in low-lying areas; ample audio output power for outstanding receive audio; durable IP54-rated polycarbonate body; and 1700 mAh Li-Ion battery. The more affordable DJ-MD5FXT boasts many of the features of the DJ-MD5XLT, including automatic repeater roaming and large full-color display, but does not include built-in GPS with APRS support. **Enter "ALO-DJ-MD5" at DXEngineering.com to compare models.**

ALO-DJ-MD5XLT Dual-Band DMR HT **CALL/WEB**
 ALO-DJ-MD5FXT Dual-Band DMR HT **CALL/WEB**
 ALO-EMS-76 Speaker Microphone **\$42.99**
 ALO-EME-56A Earphone/Microphone **\$34.99**
 ALO-EBP-87 Replacement Battery Pack, Li-Ion 1500 mAh **\$34.99**
 ALO-EBP-106 Replacement Battery Pack, Li-Ion 3250 mAh **\$42.99**
 ALO-EDC-314 Rapid Charger for EBP-106 **\$21.99**



We stock many more items than we can show. See them all at DXEngineering.com!

KENWOOD

TH-D75A
Tri-Band 144/220/430 MHz
D-STAR/APRS Handheld Transceiver

This much-anticipated, high-performance rig from the HT specialists at Kenwood builds on the success of the TH-D74 by adding advanced features and even more functionality. Users can enjoy a significant leap forward thanks to simultaneous reception of two D-STAR signals; Reflector Terminal Mode for accessing D-STAR reflectors; enhanced voice guidance (four variable speed levels, 1-7 variable volume levels, support for call sign reading with phonetic codes); built-in GPS; digipeater functions; an APRS standalone digipeater, which allows APRS coverage to be expanded even in mountainous locations; Bluetooth headset PTT support for enhanced hands-free operation; inclusion of a Type-C USB port; and an ergonomic design for comfortable operating. All this plus features you've depended on from Kenwood: superb voice clarity, with built-in audio equalizer to suit user preferences; simplex, single repeater relay, and inter-repeater gateway options; real-time messaging between stations running APRS; maximum storage of 100 stations and much more. Antenna, 1820 mAh Li-Ion battery, power adapter, and belt clip included. Enter "TH-D75A" at DXEngineering.com for more details.



New!

KWD-TH-D75A	Tri-Band D-STAR/APRS HT.....	CALL/WEB
KWD-KNB-75LAM	1820 mAh Li-Ion Battery Pack.....	\$109.99
KWD-KSC-25LSK	Rapid Charger.....	\$55.99
KWD-KMC-45D	Speaker Mic.....	\$99.99
KWD-PG-3J	Cigarette Power Adapter.....	\$51.99

ICOM IC-V86 VHF FM Portable Handheld Transceiver

The Icom IC-V86 144 MHz FM Handheld Transceiver takes the FM/2 meter portable to a new level. Enjoy 1,500 mW of audio power, 7W of RF output power, more transmit coverage, and longer operational capabilities thanks to the unit's new 2250mAh Li-Ion battery pack. Add to that an improved chassis design and speaker, the ability to easily hear incoming signals in noisy environments, compact size (2.3" x 4.4" x 1.2") and ultra-rugged construction, and you're looking at a next-class HT. Other features include 200 memory channels, 6 scan edge channels and 1 call channel; durable BNC female antenna connector; integrated VOX function; and IP54 waterproof rating. Comes with battery pack, desktop charger, belt clip and rubber whip antenna.



ICO-IC-V86	VHF FM Portable Handheld Transceiver..	CALL/WEB
ICO-BC-193-12	Desktop Charger.....	\$69.99
ICO-BP-263	Alkaline Battery Case, Holds 6 AAs.....	\$30.99

IC-T10 VHF/UHF Dual-Band FM Handheld Transceiver

Based on Icom's commercial-grade IC-F1000T radios and reminiscent of the T70 HTs, this direct conversion wideband VHF/UHF portable handheld provides a stable 5W RF output on 2 and 70cm meters, along with FM broadcast receive capabilities of 88-108 MHz. Features include 200 channel memory, priority scan, 1500mW AF output, and internal VOX and CTCSS/DTCS/DTMF encoding. The IC-T10 comes with 2280 mAh Li-Ion battery, rapid charger, AC adapter, FA-S270C dual-band antenna, and belt clip.



ICO-IC-T10	IC-T10 VHF/UHF FM HT.....	CALL/WEB
ICO-HM-158LA	Handheld Speaker-Microphone.....	\$48.99
ICO-BP-280	Replacement Li-Ion Battery Pack, 3.6 V 3,280 mAh.....	\$100.00
NIF-MM-ICT10	Nifty IC-T10 Mini Manual.....	\$21.95

ID-52A VHF/UHF Multi-Function D-STAR Handheld Transceiver



The handheld rig you've been waiting for is here! The ID-52A includes all the things you love about the ID-51A plus a number of significant upgrades designed to take your portable ops to the next level. Weighing a mere 10.4 oz., this compact unit packs a lot in a small package. Here's just some of what you get:



- Larger 2.3" transreflective color display that's easier to see even in direct sunlight
- Full-color waterfall display—the first of its kind for an HT
- Bluetooth® communication as standard, allowing for connectivity with a range of external audio devices
- Dualwatch allows for the monitoring of two frequencies or bands simultaneously. VHF/VHF, UHF/UHF and VHF/UHF monitoring are all supported along with the new ability to decode two DV signals at once
- Charging via micro USB connector
- Air band reception is expanded from VHF to UHF (225 to 374.995 MHz)
- Integrated speakers that provide an increased audio output of 750 mW
- 80% increase in overall volume to hear in loud conditions
- The latest D-STAR functions that enable you to send, receive, and view saved photos on an installed micro SD card using only the ID-52A
- Integrated GPS: Use the D-PRS mode to send location data, as well as show received station location, distance, and direction. The ID-52A also displays current Grid Square information
- DR mode for D-STAR operations for easy access to local repeaters based on the internal GPS information, as well as Terminal and Access Point modes
- Enhanced UHF capabilities allow for monitoring of Military Air Bands from 225 to 374.995 MHz, and the wideband receiver lets you listen to nearby broadcast FM stations
- Voice recorder function
- QSO log in CSV data format
- Improved heat dissipation efficiency
- IPX7 waterproof construction



For more details, enter "ID-52A" at DXEngineering.com

ICO-ID-52A	ID-52A Dual-Band D-STAR HT.....	CALL/WEB
ICO-VS-3	Bluetooth Headset w/ USB Charge Cable for ID-52A.....	\$148.99
NIF-MM-ID-52A	Nifty Mini-Manual for ID-52A.....	\$35.95

ID-50A VHF/UHF Multi-Function D-STAR Handheld Transceiver

New!

This 2M/70cm digital transceiver packs a lot of functionality and fun in a compact HT. Take advantage of the rig's band scope and waterfall displays that make it easy to find active channels; dual-watch function that doubles QSO opportunities to monitor VHF/VHF, VHF/UHF, and UHF/UHF bands at the same time; a built-in GPS receiver that displays current grid square information and can be used for Position Auto Reply, Near Repeater Search, and GPS log functions; and D-STAR, which opens up a world of possibilities to make local and worldwide contacts. Other features include IPX7 waterproof rating, multi-function USB-C port, reception of FM and Air bands, 500 memory channels, microSD card slot, and the ability to import photos into the ID-50A from a smart device (with available software download). The HT comes with Li-Ion 1880 mAh battery pack, antenna, belt clip, and hand strap.



ICO-ID-50A	ID-50A Dual-Band Digital HT.....	CALL/WEB
ICO-LC-202	Carrying Case.....	\$28.95
These accessories work with both the ID-50A and ID-52A HTs		
ICO-HM-183LS	Waterproof Speaker Mic.....	\$127.99
ICO-BP-307	Li-Ion 3150 mAh Battery.....	\$139.99
ICO-BC-202IP3L	Rapid Desktop Charger.....	\$64.99
ICO-BC-228	Desktop Charger AC Adapter.....	\$69.99
ICO-CP-25H	Cig Lighter Charger Cable for Rapid Charger.....	\$33.99
ICO-CP-12L	Cig Lighter Charger Cable w/ Noise Filter.....	\$38.99

DX ENGINEERING

Handheld Speaker Microphone for Icom D-STAR HTs

Available exclusively in North America through DX Engineering, this ruggedly built IP-67-rated remote control microphone is compatible with Icom's ID-31/50A/51/52 D-STAR series radios. It features higher audio output without the need for a powered internal amplifier, delivering louder and more intelligible audio in a larger housing compared to Icom's OE mini-mic. Made to professional-grade specifications, it comes with front-mounted pushbutton controls (Channel Up/Down and Icom A/B Function), a unique wind baffle for clearer transmitting, ergonomic design for operating with gloves on, and a clothing mic clip that provides 360 degree rotation.



DXE-MIC-ID51-52	Speaker Mic.....	\$81.99
-----------------	------------------	----------------

ON ALL BANDS
AN AMATEUR RADIO BLOG POWERED BY DX ENGINEERING

Check out our blog, OnAllBands.com, for articles on upcoming DXpeditions, what's new in contesting, digital operations, and a range of other topics. Want more? We've got loads of tech videos and interviews on the DX Engineering YouTube channel. Of course, when you want personal attention, our experts are only an email or phone call away.

DXEngineering.com is loaded with detailed photos, specs, videos, and more!

FT5DR 2M/70cm C4FM/FM Digital Handheld Transceiver

The full-featured FT5DR dual-band HT delivers all of the functionality and benefits of its sister model (FT3DR) plus some significant upgrades that make it stand out from its worthy predecessor. Take advantage of its comfort and compact size (2.44" W x 3.94" H x 1.34" D) and full-flat back body that provides excellent grasp; a reliable 5 watts of RF power output and upgraded and noticeably louder 1 watt of audio power; rugged and shock-resistant construction with rubber protection on the bottom corners of the main body; upgraded waterproof rating of IPX7; high-resolution display highlighting the frequency of the operational band; three touch panel keys and seven operation keys below the display for intuitive operability; and the new TOUCH & GO operation that allows users to immediately start communications on an often-used frequency.

Other features include: Real Dual Band Operations (V+V, U+U, V+U, U+V) available with two independent receivers; many C4FM digital communication functions; wireless hands-free operation using the optional Bluetooth® headset (SSM-BT10); built-in high-sensitivity 66 channel GPS receiver; included 2,200mAh high-capacity Li-Ion battery pack (SBR-14L1); and much more.

Enter "FT5DR" at DXEngineering.com for more details.

YSU-FT-5DR	FT5DR 2M/70cm C4FM/FM Digital HT	CALL/WEB
YSU-SHC-40	Soft Carrying Case	\$25.00
YSU-SSM-BT20	SSM-BT20 Bluetooth Headset	\$38.00
YSU-SHB-26	Replacement Quick-Release Holster	\$25.00
YSU-SCU-57	Wires-X Cable Kit w/ SCU-55/CT-44 Audio Cables	\$39.00
NIF-MM-FT5DR	Nifty FT5DR Mini-Manual Reference Guide	\$31.95

FT-60R 2M/70cm MHz Dual-Band Handheld Transceiver

Armed with wide-band (108-520, 700-999.99 MHz) receiver coverage, Yaesu's FT-60R is an excellent option for listening in the field. It packs 5 watts of power in a small package. Stash it in your glovebox or Go-Kit. What makes this HT unique is Yaesu's Emergency Automatic ID feature originally developed for search-and-rescue missions. When active, it causes the radio of the recipient (who is presumably lost or incapacitated) to transmit, search units can listen for that radio.

YSU-FT-60R	144/430 MHz Dual-Band Handheld Transceiver	CALL/WEB
------------	--	----------

YAESU YAESU



FT-65R VHF/UHF Handheld Transceiver

Small and lightweight yet darn-near bulletproof, Yaesu built this handheld to stand up to harsh use. Covering the 2 meter and 70cm bands, the FT-65R's RF power is selectable in 0.5, 2.5 and 5 watt steps, and the front firing speaker is backed by a full watt of audio amplification. This versatile rig features a programmable VFO scan, priority channel scan, WX channels/WX alert, LED flashlight, and CTCSS/DCS. Programming advanced features from a PC is simple. It comes with a 1,950 mAh Li-Ion battery providing over nine hours of operating time, and a rapid charger—all at a very attractive price tag.

YSU-FT-65R	2M/70cm Handheld Transceiver	CALL/WEB
YSU-SBR-25L1	Battery Pack, 1,950 mAh	\$39.99
YSU-SBR-26L1	Battery Pack, 2,500 mAh	\$49.99
NIF-QR-FT65R	Nifty Quick Reference Card	\$9.95



YAESU

FT-70DR C4FM FDMA FM Dual-Band Handheld Transceiver

Packing Yaesu's exclusive System Fusion digital protocol, the FT-70DR gives you both analog and digital capabilities with a very attractive price tag. Using Yaesu's clever Automatic Mode Select (AMS) function, the FT-70DR will automatically switch transmit modes depending on the received signal. A multi-color LED light provides quick, intuitive indication of the radio's current mode.

This handheld also incorporates a digital group monitor function, which allows operators to create and communicate with specific digital groups. The FT-70DR operates on the 2M/70cm bands with a 108 to 579.995 MHz extended receive range. The radio has up to 5 watts (selectable) of RF transmit power.

YSU-FT-70DR	C4FM FDMA FM Dual-Band HT	CALL/WEB
YSU-SAD-25B	Replacement Charger	\$29.99
YSU-SBH-28	Rapid Charger	\$29.99
YSU-SBR-24L1	Li-Ion Battery Pack	\$39.99
YSU-SHC-27	Soft Carrying Case	\$19.99
NIF-MM-FT70DR	Nifty Mini Manual, FT-70DR	\$24.95



ALINCO

DJ-VX50T Dual-Band Handheld Transceiver

Made to professional-grade standards, this 2M/70cm HT from Alinco is loaded with a range of features for reliable, rugged operation: FM transmit coverage from 144-148 and 420-450 MHz; built-in receive capabilities including semi-duplex dual band, VHF AM aircraft, FM broadcast and NOAA Weather radio; 5W (VHF) and 4W (UHF) output; three-color selectable display; 200 memory channels; scanning modes; and a variety of tone bursts for repeater access or selective calling. Rated IP67 for dust and water protection, the compact DJ-VX50T comes with a high-capacity 1800 mAh Li-Ion battery pack, antenna, rapid charger and belt clip.

ALO-DJ-VX50T	Dual-Band Handheld Transceiver	CALL/WEB
ALO-EBP-101	1800 mAh Li-Ion Battery Pack	\$39.99
ALO-EDH-44	Mobile DC PowerAdapter	\$19.99



YAESU

VX-6R 2M/70cm Heavy-Duty Tri-Band Ultra-Compact FM Handheld Transceiver

Ideal for severe field use, the VX-6R can withstand vibration, impacts and immersion in water. The simplified controls make it easy to access the radio's impressive list of features, including Emergency Automatic ID, VFO scanning and a battery saver/battery wake-up. Add the optional weather sensors and you'll get automatic weather updates as well. And expanded receive range covers 10 NOAA WX channels, shortwave broadcast and marine channels. It's small too, about the size of a deck of playing cards.

YSU-VX-6R	2M/220/70cm MHz Heavy-Duty Dual-Band Ultra-Compact FM HT	CALL/WEB
YSU-SBR-40L1	Li-Ion Battery Pack, 1,370mAh	\$89.99
YSU-FBA-23	Battery Case, Fits 2 AA Batteries	\$39.99
NIF-MM-VX6R	Mini-Manual for VX-6R	\$24.95



YAESU

FT-4XR VHF/UHF Handheld Transceiver

For crisp and clear audio, 5W of reliable output power, and rugged construction, Yaesu's FT-4XR VHF/UHF Dual Band FM Handheld Transceiver is a small package that delivers big time—and at a budget-friendly price. The unit's 1.4" front speaker boasts 1W of powerful audio, and its versatile scanning capabilities include VFO, Memory, Programmable Memory, Memory Bank, and Dual Receive. It comes with Selectable Frequency Step from 5 kHz; two quick programmable keys; keypad/PTT lockout to prevent accidental changes or transmissions; and 200 memory channels, 3 home channels and 10 pairs of PMS channels. Enjoy 15 hours of operating time with the supplied 1,750mAh Li-Ion battery pack. A 3.5 hour rapid charger is also included.

YSU-FT-4XR	VHF/UHF Dual-Band FM Handheld Transceiver	CALL/WEB
YSU-SBR-28L1	Li-Ion Battery Pack, 1,750mAh	\$35.99
NIF-MM-FT4XR-VR	Nifty Mini Manual, FT-4XR/VR	\$21.95



YAESU			YSU-FT-60R	YSU-VX-6R	YSU-FT-65R	YSU-FT-4XR	YSU-FT-5DR
Accessory	Part Number	Description					
Coax Adapter	YSU-CN-3	Coaxial Cable Adapter, BNC (F) to SMA (M)	x	x			x
AC Adapter	YSU-SAD-24B	AC Adapter	x	x			
Cables	YSU-SDD-13	DC Cable, Car Cigar Lighter Plug with Noise Filter	x	x			x
	YSU-E-DC-6	DC Cable, with Plug	x	x			
	YSU-CT-27	Interface/Cloning Cable					
	YSU-CT-44	Mic Adapter Cable, 2-conductor (F) to TRRS Plug	x				x
	YSU-SCU-36	Cloning Cable			x	x	
Speaker Mics	YSU-SSM-59	Programming Cable			x	x	
	YSU-SSM-17A	Speaker Mic	x				x
	YSU-MH-73A4B	Speaker Mic, Waterproof		x			
	YSU-SSM-17H	Speaker Mic with Swivel Clip & 3.5mm Audio Jack		x			
Battery Pack	YSU-SSM-17B	Speaker/Mic 2-Pin			x	x	
	YSU-SSM-512B	Earpiece Microphone, VOX			x	x	
Battery Case	YSU-FNB-83	Battery Pack	x				
	YSU-FBA-25A	Battery Case	x				

DX Engineering carries equipment from more than 160 top manufacturers!



ICOM IC-R8600
Wideband Digital Receiver

The software-designed IC-R8600 covers an impressive 0.01 to 3000 MHz, and will receive a wide range of analog and digital modes, like D-STAR, P25, NXDN and dPMR. The IC-R8600 packs several improvements, like a larger 4.3 inch touchscreen with a fast moving spectrum scope and waterfall display. Advanced FPGA processing provides enhanced signal clarity and accuracy. I/Q signal output allows use of third-party SDR software and external decoding. The SP-39AD speaker, designed specifically for use with the RG8600, features exceptional sound plus distinctive styling to exactly match your superb R8600 receiver. A nice ICOM design touch was to include a dedicated R8600 power supply right in the speaker.

- ICO-IC-R8600 Wideband Digital Receiver **CALL/WEB**
- ICO-SP-39AD Receiver Speaker for IC-R8600 **\$279.99**
- ICO-AD-55NS Power Supply for IC-R8600 **\$73.99**

IC-R6 SPORT
Communications Receiver

Carry a mammoth frequency range in the palm of your hand—from 0.100 to 1309.995 MHz! That includes utility and government communications, Amateur Radio, AM, FM, and shortwave broadcast stations. A clever voice squelch control makes it easy to pick out the voices from the cacophony of data bursts and beacons. It has 1,300 memory channels and robust scanning capabilities.

The IC-R6 Sport has a built-in ferrite bar antenna for AM broadcast and a large, backlit LCD screen. It's powered by 2 AA batteries (not included) or via optional power cords.

- ICO-IC-R6SPORT IC-R6 Sport Communications Receiver, Black **CALL/WEB**



DX PATROL

Ultra Wide-Band Coverage SDR Receiver MK4

Using cutting-edge software-defined tech, the DX Patrol Ultra Wide-band Coverage SDR Receiver MK4 gives you incredible 100 kHz to 2 GHz receive range capability with extraordinary dynamic range. But the bigger surprise is the MK4's size—it fits in the palm of your hand. The unit connects to your PC or Android-powered tablet or smartphone via USB to deliver an intuitive display and crystal-clear audio reception.

The MK4 has two separate SMA connectors to add your own HF and VHF antennas. It uses software that's completely free and setup is straightforward. A Micro-USB cable and SMA-to-BNC adapter are included.

- DXP-DX-PATROLMK4 Ultra Wide-Band Coverage SDR Receiver MK4 **\$109.95**



redpitaya

SDRlab 122-16

With a frequency range to 62.5 MHz and 16 bits of resolution, the upgraded SDRlab 122-16 represents a powerful and affordable core of the SDR radio that you build. The board offers these benefits:

- Tailored for SDR and other RF applications: HF and 50MHz bands
- No DC coupling. Minimum RF Input frequency (-3dB): 300kHz
- Comes with two 16 bit ADCs 50 Ω inputs; 14 bit DACs 50 Ω outputs
- Three times bigger dual core ARM Cortex A9 + Xilinx Zynq 7020 FPGA
- Bigger FPGA provides more real-time processing capabilities
- Hardware compatible with HPSDR
- Improved distortions, dynamic range, sensitivity, noise and crosstalk

The kit includes circuit board, SD card (16GB, class 10), ETH cable (1m), and power supply (5V, 2A). Enter "Red Pitaya" at DXEngineering.com for many more details.

- RYA-SDRLAB12216 SDRlab 122-16 Board Kit **\$739.99**



rt SYSTEMS
RADIO PROGRAMMING MADE EASY



Programming/Cloning Software and Cables

RT Systems makes programming your radio much less tedious. Instead of pressing buttons and reading small LCD screens, you can simply scroll through checkboxes and enter information with your keyboard. When noted, the proper interface cable comes with the software. The cables are also available separately. Find more at DXEngineering.com.

Part Number	Radio	Cable	Price
RTP-APK-VX50-USB	Alinco DJ-VX50	USB-29A	\$48.99
RTP-DMR-D578-USB	Anytone AT-D578	USB-RT49	\$35.00
RTP-DMR-D878-USB	Anytone AT-D878	USB-74	\$35.00
RTP-WCS-705-USB	Icom IC-705	USB RT-49	\$35.00
RTP-WCS-2300-USB	Icom IC-2300	USB-29A	\$49.95
RTP-WCS-2730-USB	Icom IC-2730A	USB-29A	\$48.99
RTP-WCS-7100-RT	Icom IC-7100	USB-RT41	\$35.00
RTP-WCS-7300-USB	Icom IC-7300	USB-RT42	\$34.99
RTP-WCS-9700-U	Icom IC-9700	—	\$35.00
RTP-WCS-R8600USB	Icom IC-R8600	USB-RT42	\$48.95
RTP-WCS-V86-USB	Icom IC-V86	USB-29A	\$48.99
RTP-WCS-D5100USB	Icom ID-5100	USB-29A	\$48.99
RTP-WCS5100DATA	Icom ID-5100A	USB-RTS05	\$48.99
RTP-WCS-T10-USB	Icom IC-T10	USB-29A	\$49.00
RTP-WCS-V3500USB	Icom IC-V3500	USB-29A	\$49.00
RTP-KRS-D74-USB	Kenwood TH-D74A	USB-A/B	\$49.99
RTP-KRS-D75-USB	Kenwood TH-D75A	USB-A/B	\$35.00
RTP-KRS-V71-USB	Kenwood TM-V71A/E	USB-K5G	\$49.95
RTP-KRS-590-USB	Kenwood TS-590	USB-63	\$48.99
RTP-ADMS-450-USB	Yaesu FT-450	USB-63	\$49.95
RTP-ADMS-1J-USB	Yaesu FT-60	USB-57A	\$48.99
RTP-ADMS-65-USB	Yaesu FT-65	USB-55	\$48.99
RTP-ADMS-4B-USB	Yaesu FT-857/897	USB-62	\$48.99
RTP-ADMS-891-USB	Yaesu FT-891	USB-A to USB-B	\$34.99
RTP-ADMS-991A-U	Yaesu FT-991/A	—	\$24.99
RTP-ADMS-991AUSB	Yaesu FT-991/A	USB-A/B	\$49.99
RTP-ADMSM3100USB	Yaesu FTM-3100	USB-29F	\$48.99
RTP-ADMS-VX6-USB	Yaesu VX-6	USB-57B	\$48.99
RTP-YPS-DX10-USB	Yaesu FTDX-10	USB-B	\$35.00
RTP-YPS-DX101USB	Yaesu FTDX-101D/MP	USB-A to USB-B	\$35.00
RTP-YPS-FT3D-U	Yaesu FT-3D	—	\$25.00
RTP-YPS-FT3D-USB	Yaesu FT-3D	USB-68	\$48.99
RTP-YPS-FT5D-U	Yaesu FT-5DR	—	\$25.00
RTP-YPS-FT5D-USB	Yaesu FT-5DR	USB-68	\$49.00
RTP-YPS-F710-U	Yaesu FT-710	—	\$25.00
RTP-YPS-F710USB	Yaesu FT-710	USB-RT42	\$35.00
RTP-YPS-4XV-USB	Yaesu FT-4X/V	USB-55	\$48.99
RTP-YPS-M-200-U	Yaesu FTM-200	—	\$25.00
RTP-YPS-M-200USB	Yaesu FTM-200	USB-77	\$48.99
RTP-YPS-M300-U	Yaesu FTM-300DR	—	\$25.00
RTP-YPS-M300-USB	Yaesu FTM-300DR	USB-77	\$48.99
RTP-YPS-M500-U	Yaesu FTM-500DR	—	\$25.00
RTP-YPS-M500-USB	Yaesu FTM-500DR	USB-77	\$48.99
RTP-YPS-M6000-USB	Yaesu FTM 6000	USB-77	\$48.99
RTP-YPS-7250-USB	Yaesu FTM-7250	USB-29F	\$48.99
RTP-YPS-818-USB	Yaesu FT-818	USB-62	\$48.99

Radio Interface Cables

RT Systems has cables for many of the most popular radios in use today. They are compatible with various handhelds, mobiles, HF rigs and receivers from common manufacturers.

Part Number	Radio	Cable	Price
RTP-USB-57B	Alinco, Yaesu	USB to 4-Conductor TRRS 3.5mm Plug	\$29.99
RTP-USB-RTS05	Icom	USB to Stereo 2.5mm Male Plug	\$30.95
RTP-USB-RTS01	Icom	USB to Stereo 3.5mm Male Plug	\$29.99
RTP-USB-K4Y	Kenwood	USB to 3.5/2.5mm Plug	\$30.95
RTP-USB-K5G	Kenwood	USB to 8-Pin Mini DIN	\$29.99
RTP-USB-63	Kenwood, Yaesu	USB to Female DB-9	\$29.99
RTP-RT-42	Yaesu, Icom	USB A to USB B	\$11.99
RTP-USB-29B	Yaesu	USB to 6-Pin Mini DIN	\$29.99
RTP-USB-62	Yaesu	USB to 8-Pin Mini DIN	\$29.99
RTP-USB-68	Yaesu	USB to Mini-B	\$29.99
RTP-USB-74	AnyTone/ Baofeng	USB Type A to 2-Pin Mic	\$11.00
RTP-USB-77	Yaesu	USB to 10-Pin Mini DIN	\$30.00

Don't see the cable you need? Check out DXEngineering.com, there's a good chance we have it!

Check out our YouTube channel for in-depth tech tips and product demos!

18 Digital Interfaces

SignalLink™ PC/Radio Sound Card Interface

The SignalLink USB combines the legendary performance of the original SignalLink SL-1+ with a state-of-the-art, built-in low-noise sound card. All sound card digital and voice modes are supported by the SignalLink USB. This includes traditional modes such as RTTY, SSTV and CW, as well as today's hottest new modes like PSK-31, MT-63 and EchoLink®. The front panel controls let you adjust your Transmit Audio, Receive Audio and Transmit Delay on the fly.



TGR-SLUSB13I-P

The SignalLink USB needs just one USB connection to the computer and one connection to the radio (in most cases). Convenient front panel controls make setup and operation very easy. The SignalLink USB is fully isolated and is compatible with all radio Mic, Data and Accessory ports. The SignalLink USB allows you to use your computer's sound card for other functions while enjoying digital communications.

Just order the correct, fully-assembled interface cable for your radio(s) and simply "plug and play." Cables are available for a mic connector interface or rear DIN plugs on radios so equipped. It makes for a neat, clean installation.

- Easy to set up
- Works with all radios
- Just plug in two cables
- Powered via USB cable
- Software included
- Easy hookup to Mac or PC
- Built-in sound card
- Comprehensive, easy instructions

SignalLink USB Digital Communications Interface Combos —To make installation easier, DX Engineering created combos that pair a Tigertronics SignalLink with a radio-specific interface cable. The manufacturers are listed below; or visit DXEngineering.com.

Part Number	Radio	Price
TGR-SLUSB13I-P	Icom 13-Pin DIN and SL-USB	\$149.95
TGR-SLUSB13K-P	Kenwood 13-Pin DIN and SL-USB	\$149.95
TGR-SLUSB4R-P	Drake 4-Pin Mic and SL-USB	\$149.95
TGR-SLUSB5PD-P	Yaesu, TEN-TEC 5-Pin DIN	\$149.95
TGR-SLUSB6PM-P	Icom, Kenwood, Yaesu 6-Pin Mini-DIN and SL-USB	\$149.95
TGR-SLUSB8PM-P	Xiegu G90/X5105/Others 8-Pin Mini-DIN and SL-USB	\$149.95
TGR-SLUSB8PD-P	Icom, TEN-TEC 8-Pin DIN and SL-USB	\$149.95
TGR-SLUSB8R-P	Icom, Alinco, Elecraft, Kenwood, Yaesu 8-Pin MIC & SL-USB	\$149.95
TGR-SLUSBHTW-P	Kenwood, Baofeng, Wouxun HT Plug and SL-USB	\$149.95
TGR-SLUSBHTY-P	Yaesu HT Plug and SL-USB	\$149.95
TGR-SLUSBK3-P	Elecraft K3 and SL-USB	\$149.95
TGR-SLUSBK3X-P	Elecraft K3X Plug and SL-USB	\$149.95
TGR-SLUSBNC-P	No Connector DIN and SL-USB	\$149.95
TGR-SLUSBRJ1-P	Yaesu RJ11 6-Pin Modular and SL-USB	\$149.95
TGR-SLUSBRJ4-P	Icom, Kenwood, Alinco, Yaesu RJ45 and SL-USB	\$149.95
TGR-SLUSB847-P	Yaesu 3.5mm Data I/O Jack and SL-USB, FT-847	\$149.95
TGR-SLUSBVXY-P	Yaesu HT TRRS Mic/Speaker Plug and SL-USB	\$149.95

Preprogrammed "Plug and Play" Radio Jumper Modules		
TGR-SL-MOD5PD	Jumper Module, TEN-TEC/Yaesu 5-Pin DIN Interface	\$9.95
TGR-SL-MOD4RT	Jumper Module, TEN-TEC 4-Pin Round Mic Jack	\$9.95
TGR-SL-MODHT	Jumper Module, Yaesu HT, use w/SLCABHTY Cable	\$9.95
TGR-SL-MOD6PM	Jumper Module, 6-Pin Mini-DIN	\$9.95
TGR-SL-MOD8PD	Jumper Module, 8-Pin DIN	\$9.95
TGR-SL-MODK3	Jumper Module, Elecraft K3	\$9.95
TGR-SL-MODKX3	Jumper Module, Elecraft KX3	\$9.95

SignalLink Radio Interface Cables—You need the right cable for your SignalLink. If you change radios, add these to your existing SL-USB. These cables use either your radio's mic connector or rear DIN port. Some radios do not have the "RX Audio" signal on the mic connector and will require a mono cable between the SignalLink USB and the radio. You can avoid this issue by attaching the SignalLink to your radio's Data or Accessory port.

Part Number	Description	Price
TGR-SL-CAB4R	4-Pin Round Mic Connector Interface Cable	\$25.95
TGR-SL-CAB8R	8-Pin Round Mic Connector Interface Cable	\$25.95
TGR-SL-CABRJ1	RJ11 Mic Connector Interface Cable	\$25.95
TGR-SL-CABRJ4	RJ45 Mic Connector Interface Cable	\$25.95
TGR-SL-CAB5PD	5-Pin TEN-TEC/Yaesu DIN Interface Cable	\$25.95
TGR-SL-CABHTY	Yaesu HT Interface Cable	\$25.95
TGR-SL-CABVXY	Yaesu TRSS Mic/Speaker Plug	\$25.95
TGR-SL-CAB847	Yaesu 3.5mm I/O Jack	\$25.95
TGR-SL-CABHTW	Kenwood, Baofeng and Wouxun HT Interface Cable	\$25.95
TGR-SL-CAB8PD	8-Pin DIN Interface Cable	\$25.95
TGR-SL-CAB8PM	Xiegu G90/X5105/Others 8-Pin Mini-DIN Interface Cable	\$25.95
TGR-SL-CAB13I	13-Pin DIN Icom Interface Cable	\$25.95
TGR-SL-CAB13K	13-Pin DIN Kenwood Interface Cable	\$25.95
TGR-SL-CAB6PM	6-Pin Mini-DIN Interface Cable	\$25.95
TGR-SL-CABNC	Unterminated Cable Interface Cable	\$25.95
TGR-SL-CABK3	Special Elecraft K3 Interface Cable	\$25.95
TGR-SL-CABKX3	Special Elecraft KX3 Interface Cable	\$25.95



microHAM

Digital Interfaces

The innovators at microHam have two digital mode interfaces that make great additions to any shack. The micro KEYER III Digital Mode and Radio Control Interface is the world's first USB interface to feature high dynamic range and 24-bit audio processing for all modes. This single-radio, all-in-one USB interface supports digital, voice, and microphone switching in one box and features two separate channels supporting transceivers with two audio outputs (main and sub-receivers). With a single USB port, it works with any Windows-based logging or control program, as well as Linux and macOS, for CW, voice, FSK, and digital operation. The lightweight and portable DXP Radio Interface is a transceiver-to-computer USB device that features quiet operation; easy configuration; jumper-free rig control interface for CAT, CI-V with a built-in level converter for many brand-name rigs; and 24-bit audio ADC and DAC for high-quality digital operation. CW operation is supported by the WinKey CW Keyer (version 3.1) developed by K1EL. Its 24-bit USB sound card provides improved signal-noise ratio, greater dynamic range (>105dB), lower noise floor, and improved weak-signal decoding compared to standard 16-bit audio interfaces or USB-enabled transceivers.

Enter "MOH Digital USB" at DXEngineering.com for more details.

- MOH-MK-3 micro KEYER III Digital Mode/Radio Control Interface.....**\$449.99**
- MOH-DXP-DXP DXP Portable Digital Mode/Radio Control Interface.....**\$339.99**

Digital Modes + Rig Control Interface



Connect the RIGblaster Advantage to your radio's microphone connector, and a computer USB connector and you'll have access to over 100 existing and future Ham radio sound card software programs! You'll also get over 20 exciting modes that your radio could not otherwise operate. The Advantage also links your computer software and radio using CAT, CI-V or DB9 interface cables.

WMT-58012-1288 RIGblaster Advantage.....**\$209.95**

RIGblaster Cables and Accessories

To maximize the potential of your RIGblaster, adapters, kits and accessories are available.

Part Number	Description	Price
WMT-58107-971	RIG Control Cable for CI-V (Icom and TEN-TEC) Radios	\$9.95
WMT-58108-972	CAT Cable for Yaesu FT-100/100D/817/857/897	\$10.95
WMT-58108-974	CAT Cable for Yaesu FT-736/747/767/990/1000	\$12.95
WMT-58111-975	Instant Setup Quick Connector Kit for Icom, Yaesu, Kenwood	\$19.95
WMT-58136-1000	4-/8-Pin to RJ45 Conversion Kit	\$24.95
WMT-58137-1001	AC Power Supply for RIGblaster M8, Plus, Pro	\$14.95



Check out our blog, OnAllBands.com, for articles on upcoming DXpeditions, what's new in contesting, digital operations, and a range of other topics.



Most in-stock parts ship throughout the contiguous US in just 1-2 days!



Parametric Receive Audio System (PRAS)

Using three separate equalization controls, Heil's Parametric Receive Audio System (PRAS) enables operators to enjoy clearer voice articulation in receive audio through more precise adjustments of midrange frequencies. The unit allows operators to adjust the parametric midrange filter from 400 Hz through 4 kHz, and control the presence of these midrange frequencies plus or minus 15dB. Combined with a low-frequency filter down to 160 Hz, and a high-frequency filter up to 6 kHz, the PRAS provides operators unparalleled control and quality of their receive audio. Heil's two-way Powered Speaker (HPS-5), sold separately, is specifically designed for use with PRAS. The speaker features a low-distortion, highly efficient Class D 24 watt amplifier that drives the specially designed 5" low-frequency driver with a 3" magnet mounted in a resonant sealed enclosure. A passive extended crossover drives a 2" high-frequency tweeter.

- HLS-PRAS-EQ Parametric Receive Audio System **\$269.00**
- HLS-HPS-5 Powered Speaker for Parametric Receive Audio System **\$199.00**



Compact In-Line DSP Noise Eliminating Module

Take high-performance noise cancelling into the field with his battery-powered option. It delivers bhi's latest noise suppression technology, and is small and rugged enough to be tucked into a duffel bag. The module is designed to work with headphones, but may also work with a compact, portable external speaker. A front-panel knob allows to you fine-tune your noise cancelling level.



- BHD-COMPACTINLINE Compact In-Line DSP Noise Eliminating Module **\$279.99**



Dual In-Line DSP Noise Eliminating Module

Many new radios (including most SDRs) have stereo audio capability. bhi's Dual In-Line accepts two separate audio signals to allow for stereo output. It can also be fed by two different signals, which is handy if you run multiple radios in your station. The dual outputs also mean you can monitor two separate signals at the same time. It also has separate seven watt audio and headphone outputs. It's an ideal DSP noise cancelling module for club events, Field Day or multi-radio DX stations.



- BHD-DUAL-IN-LINE Dual In-Line DSP Noise Eliminating Module **\$279.99**
- BHD-DL-STD1 Dual In-Line Mounting Stand **\$17.59**

DSP Noise Cancelling In-Line Module



Hear more clearly with this audio DSP unit that cleans up noisy signals and delivers more intelligible audio across all bands. Just use the included 3.5mm male mono patch cable to connect the in-line module between your radio and external speaker. Using simple controls, users can select eight noise-cancelling levels via a rotary switch (8 to 40 dB). Other features include the latest DSP noise-cancelling technology, tone reduction up to 65 dB, 5W audio amplifier, audio input overload indicator, and audio bypass feature which routes the signal directly through to the loudspeaker when the unit is switched off. The In-Line Module works on most radios and receivers.



- BHD-IN-LINE DSP Noise Cancelling In-Line Module **\$265.99**



Ground Breaker RFI Blocking Device

You've checked your connections, experimented with different power supplies, and upgraded your ground system. Still have RFI? Then put Ground Breakers to work. These nifty devices totally isolate the ground of your accessory audio equipment from those of the radio system. Line level units can handle 500 mW for the 8 Ω model. To install, simply plug the Ground Breaker into the appropriate socket on your radio and then plug in the audio accessory, such as the digital signal processor or powered speaker, into the socket on the Ground Breaker. Available for mono and stereo applications.



- BHD-GB8M 8 Ω Mono Ground Breaker **\$48.99**
- BHD-GB8S 8 Ω Stereo Ground Breaker **\$48.99**



RXSHARE Audio Switch for Multi- and Single-Operator Contesting



In the heat of a contest, serious competitors are always looking for an edge that can push them to the top. The experts at DX Engineering understand the hurdles contesters face, especially when a pair of operators need to hear the same receiver outputs. The RXSHARE Audio Switch gives two operators complete control of the specific audio they want fed to their stereo headphones, while either operating two separate radios or one shared radio. This means better coordination, fewer interruptions, less fatigue, and more QSOs. Each operator controls a three-position switch that allows them to listen to one, the other, or both channels of audio. These selections can be changed independently by each operator thanks to the unit's silent rocker switches.

In "Multi-Two" or "Multi-Single" contesting, the RXSHARE lets one operator hear when a new station is ready to be worked or when the other operator is going to work them. Using the RXSHARE in the "Separate Radios" mode, each operator may choose to listen to Radio 1 audio or Radio 2 audio in both ears, or either operator can listen to the audio from both radios in each ear. In the "Shared Radio" mode, the RXSHARE provides a convenient way of splitting the audio output of a single radio.

For single-operator/two-radio contesting, the operator can listen to the same audio in both ears from a single radio, or hear the audio from each radio in one ear for simultaneous CQ-ing and tuning for new contacts. Advanced operators can even manage two pileups at once on different bands.

The sturdy, stainless steel RXSHARE (10.50" W x 2.50" H x 3.25" D) features a clearly marked front panel and two sets of stereo headphone outputs including 1/4 inch (6.35mm) and 1/8 inch (3.5mm) stereo jacks to accommodate headphones or headsets with either type of plug.

- DXE-RXSHARE Audio Switch for Multi- and Single-Operator Contesting **\$251.99**



Wolf-100 WOLFVALE Advanced Audio Processor



Connect the transformative SOTABeams' WOLFVALE Advanced Audio Processor to your headphones or speaker and you may wonder how you've operated all these years without it—especially if you have struggled with hearing loss. Easily accessed menu selections presented on the OLED screen let you choose how you wish to enhance your radio listening experience. Functions and features include:

- Fully adjustable audio band pass filtering from 50 Hz to 5 kHz, instantly adjustable for voice, data and CW
- Bright, clear, real-time audio spectrum display shows what's happening in your radio's audio passband
- Adaptive DSP noise reduction with 100 levels, plus advanced control functions
- Adaptive DSP tone eliminator gets rid of annoying carriers, but leaves the desired signals
- Menu-selectable age-related hearing loss correction using ISO 7029:2017 median hearing-loss curves for males or females
- Memories to easily store and recall your favorite settings
- Audio test generator including two-tone test mode, sine, square and triangular wave
- Experimental CW regenerator to enjoy noise-free CW QSOs
- User updatable firmware by USB—Add a Morse Code Reader!

Note: Available on firmware-updated units, the WOLFVALE's new start-up sound, based on "WW" on Morse code, was composed by professional musician, Chris Rolinson GTDDN.

For many more details of this versatile and powerful device, enter "WOLF" at DXEngineering.com.

- SBM-WOLFVALE WOLFVALE Advanced Audio Processor **\$279.99**



Radio ClearSpeech Noise Reduction Speaker and Processor



The CLRspkr is a compact, portable loudspeaker containing an adaptive DSP noise reduction circuit with a 10 watt audio amplifier. The ClearSpeech® adaptive DSP algorithms analyze the noise content of the incoming signal, then attenuate or completely remove hum, hiss, ignition and power line noise, static and heterodynes. What you hear is clean voice and CW with over 85% of the noise removed. If you have an external speaker that you like, the ClearSpeech DSP processor unit will give you the clean sound you want. It installs between your radio and the speaker.

- WMT-58407-948 DSP Speaker **\$219.95**
- WMT-58407-949 DSP Processor **\$219.95**

Join our crew on Facebook for news and exclusive deals!



ParaPro EQ20

Any audio engineer will tell you how valuable a parametric EQ can be. It allows you to boost/cut specific frequencies so you can fine-tune your audio on the fly for better voice copy. bhi's new ParaPro units combine a robust parametric EQ with a 20 watt audio amplifier. The controls are intuitive, allowing you to easily and quickly adjust the ParaPro's frequencies—a great Contesting companion.

bhi offers a ParaPro with a built-in adjustable noise canceling DSP unit, which will automatically filter out background noise and enhance the human voice. You can also get the ParaPro with Bluetooth® capability that lets you turn your wired speakers into wireless speakers. It's a smart way to clean up your shack's wiring and open up some unique installation possibilities.

BHD-EQ20	ParaPro EQ20	\$285.99
BHD-EQ20B	ParaPro EQ20 with Bluetooth	\$319.99
BHD-EQ20-DSP	ParaPro EQ20 with DSP Unit.....	\$425.99
BHD-EQ20B-DSP	ParaPro EQ20 with Bluetooth and DSP Unit.....	\$469.99



BHD-EQ20B

25W Extension Speaker

This robust 8 Ω two-way passive extension speaker is ideal for use with bhi in-line DSP modules or as a standalone external speaker for your radio. It can be connected directly to a transceiver or to DSP units with audio power amplifiers such as the bhi ParaPro EQ20. The EXTSPK25 features a 4" bass driver and a 1" tweeter for excellent audio. It connects directly to most transceiver and receiver standard mono external speaker outputs or to DSP unit speaker outputs. Order two for stereo, dual-channel transceivers. Measures 6.30" W x 7.87" H x 5.90" D.

BHD-EXTSPK25	25W Extension Speakers	\$74.99
--------------	------------------------------	----------------



Line Level Converter for ParaPro EQ20

A proven performer, bhi's LLC-1 Line Level Converter changes a speaker output to a line level signal, adding even greater flexibility to bhi's ParaPro EQ20 Parametric Equalizer. Designed with input from active amateur operators, the inline module features audio isolation transformers that protect the class D amplifier stage on the EQ20 when using your own powered speakers.

BHD-LLC1	Line Level Converter for EQ20	\$60.99
----------	-------------------------------------	----------------



ATT2 Attenuator Pad

This handy device is used to convert high level audio signals to low level audio, making it easier to control the audio input on the bhi ParaPro EQ20. The unit can also be used with other audio equipment that meet ATT2 specs. The passive ATT2 enables a wider range of AF/volume adjustments to be made before triggering the overload LED on the EQ20. The unit accepts mono or stereo speaker level signals up to 1 watt and will attenuate the audio down to line level at around 1 volt.

BHD-ATT2	Attenuator Pad for ParaPro EQ20	\$37.99
----------	---------------------------------------	----------------



Extension Speaker

This 20W, 4 Ω speaker is useful as an extension speaker for your bhi in-line modules, or for any radio in your shack or mobile rig. Measuring 4.9" W x 5.1" H x 2.9" D, the LSPKR speaker comes with a 6.5' audio cord and adjustable mounting bracket that can be used as a stand.

BHD-LSPKR	Extension Speaker.....	\$40.99
-----------	------------------------	----------------



PWRspkr Amplified Speaker

Packing 15 watts of amplification, this speaker is great for noisy shacks, loud mobile installations or radios with weak audio output. The PWRspkr is tailored to the 300-3200 Hz range for the human voice sweet spot. It features a 4.25" speaker, requires 13.8 Vdc, and includes a 6' audio cable and mounting bracket.

WMT-58406-947	15 Watt Amplified Speaker	\$79.95
---------------	---------------------------------	----------------



Communications Speaker

Plug in the speaker and bring out communication speech fidelity that you never knew existed. It restores the smooth sound of sine waves that CW naturally generates and makes it easy to copy. The ClearTone speaker improves speech intelligibility in the 600 to 4000 Hz frequency range while reducing undesirable noise static and hum. It has a 6' cord and 3.5mm mono plug. Output: 8 watts. Impedance: 8 Ω. Dimensions: 3.75" H x 3" W x 2.25" D.

DXE-281	Communications Speaker.....	\$16.99
---------	-----------------------------	----------------



DESKTOP-MKII DSP Noise Cancelling Speaker

The new MKII model includes the latest bhi DSP noise-cancelling technology for even better receive audio! Tailored toward a base station setup, the 10 watt amplified speaker creates a sublime listening experience. Along with its upgraded DSP capabilities, it features a tweeter/bass driver combo that rivals home entertainment systems. It accepts either speaker- or line-level input, and has a separate headphone jack for using the speaker's DSP with your own headset.

BHD-DESKTOP-MKII	DESKTOP DSP Noise Cancelling Speaker	\$329.99
------------------	--	-----------------



NES 10-2MK4 DSP Noise Cancelling Speaker

Upgraded from bhi's popular MK3 model, the MK4 noise elimination speaker handles up to 5W high level input from any radio that has a high level audio output. The speaker effectively removes unwanted background noise and interference from noisy voice and radio communication channels to leave clear, intelligible speech and CW signals. This compact unit (4.33" W x 2.56" H x 2.17" D) features noise cancelling capabilities from 8 to 40 dB, tone reduction up to 65 dB, significantly improved signal to noise ratio, and eight levels for filtering QRM/QRN. It's suitable for both your base station and mobile setup in a vehicle. Enter "NES10" at DXEngineering.com for more details.

BHD-NES10-2MK4	DSP Noise Cancelling Speaker	\$199.99
----------------	------------------------------------	-----------------



RHEA Speakers

Designed to match the capabilities of modern transceivers, the Phonema RHEA-2 and RHEA-3 Speakers make a great-looking and even better-sounding addition to any shack. Manufactured with high-end acoustic materials and matched with a high-quality 8 ohm driver, they deliver a rich, balanced sound that is perfect for listening to your transceiver or receiver for hours. The speakers (7.3" W x 4.3" H x 10.82" D) are conveniently sized to match a range of Icom, Yaesu, Kenwood and Elecraft rigs, but will also work with other transceivers with similar dimensions. The box includes AG150 and Basotect acoustic foam materials for superb sound. The RHEA-3 version accepts two audio inputs selected by a front panel switch. Enter "RHEA" at DXEngineering.com for more details.

PNE-RHEA-2	RHEA-2 Speaker	\$289.99
PNE-RHEA-3	RHEA-3 Speaker, Accepts 2 Selectable Audio Inputs	\$345.99



RIGblaster DXpro Sound Card Interface

Whether you're interested in chasing DX with weak-signal modes, RTTY and SSB contesting, or operating remotely over the Internet, take a serious look at the RIGblaster DXpro sound card interface from West Mountain Radio. Combining dual sound cards and advanced software-controlled features, the RIGblaster DXpro works with all sound card based digital mode programs and logging software. The sound cards allow simultaneous monitoring of main and sub receivers. You can run digital mode programs on each channel, making it an excellent choice for SO2V/SO2R. The unit allows you to operate your favorite digital mode program simultaneously with your favorite logging program. Precision-engineered in the USA with extensive RF filtering, it's fully compatible with RemoteHams/HRD for remote control of your station and includes switchable 12V DC output for remotely controlling a small station accessory such as a TNC or 12V relay. Seven pre-wired jumper blocks included, covering most Icom, Yaesu, Kenwood, Elecraft, and Alinco radios. Supplement the interface with the DXKey Remote, a four-button analog keypad that can be attached to the device to trigger voice recordings. The AC Control Kit lets the RIGblaster DXpro control an AC device.

WMT-58001-1809	RIGblaster DXpro Sound Card Interface.....	\$349.95
WMT-58142-1819	RIGblaster DXpro DXKey Keypad	\$19.95
WMT-58142-1820	RIGblaster DXpro AC Control Kit.....	\$65.95

Orders over \$99 qualify for FREE standard shipping—see pg. 74 for details.



PNE-I34A

PNE-Y40A

PHITS Acoustic Modification Kits

A speaker driver is only part of the equation. High quality acoustic reproduction requires a cabinet with the proper amount of baffling, porting and resonance. Phonema's Acoustic Modification Kits let you add specialized internal foam and filling to get the most out of your speaker's existing cabinet, without having to swap the driver.



PNE-I23A	Kit for Icom SP-23.....	\$51.99
PNE-I34A	Kit for Icom SP-20, SP-34.....	\$73.99
PNE-I41AX	Kit for Icom SP-41.....	\$94.99
PNE-K23A	Kit for Kenwood SP-23, SP-120, SP-430.....	\$41.99
PNE-K31	Kit for Kenwood SP-31.....	\$49.99
PNE-K89A	Kit for Kenwood SP-890.....	\$66.99
PNE-K95A	Kit for Kenwood SP-950/940/930/230/180.....	\$66.99
PNE-K99	Kit for Kenwood SP-990.....	\$72.99
PNE-TT07	Kit for Ten Tec 307.....	\$59.99
PNE-Y2KA	Kit for Yaesu SP-2000.....	\$70.99
PNE-Y6A	Kit for Yaesu SP-6/767/102.....	\$66.99
PNE-Y8A	Kit for Yaesu SP-8.....	\$63.99
PNE-Y9K	Kit for Yaesu SP-9000.....	\$95.99
PNE-Y10A	Kit for Yaesu SP-10.....	\$41.99
PNE-Y101A	Kit for Yaesu SP-101.....	\$67.99
PNE-Y20A	Kit for Yaesu SP-20.....	\$51.99
PNE-Y30A	Kit for Yaesu SP-30.....	\$49.99
PNE-Y40A	Kit for Yaesu SP-40.....	\$47.99



Universal PHITS Kit

This kit comes with three types of acoustic foam that you can trim yourself to enhance the sound quality of your speakers. Kit includes acoustic material only.

PNE-SPX0	Universal PHITS Kit.....	\$55.99
----------	--------------------------	----------------



PHITS Acoustic Modification Kit for Icom SP-38

Take the next step in upgrading the sound quality of your Icom SP-38 external speaker by adding internal foam and filling designed specifically to produce less reverberation, better intelligibility, and improved frequency response.



PNE-I38AX	PHITS, Speaker Sound Quality Upgrade for Icom SP-38.....	\$82.99
-----------	--	----------------

PNE-GPH-K23



PNE-GPH-Y2K



PNE-GPH-X91



GAMMA PHITS Speaker Modification Kits

These kits swap your existing driver for a superior-quality neodymium unit. The new driver boasts better frequency response and power handling capability. You'll find similar drivers in big-buck audiophile sound systems. These driver kits are also a smart replacement for an old or damaged driver.

Speaker Driver Kits

PNE-GPH-I23	For Icom SP-23.....	\$34.99
PNE-GPH-K23	For Kenwood SP-23*, SP-120, SP-430.....	\$43.99
PNE-GPH-K23X	Speaker Driver Kit for Kenwood SP-23 with Plastic Face.....	\$41.99
PNE-GPH-K31	For Kenwood SP-31.....	\$64.99
PNE-GPH-X80	For Kenwood SP-180/230, Yaesu SP-767/102.....	\$49.99
PNE-GPH-X90	For Kenwood SP-990.....	\$44.99
PNE-GPH-X91	For Yaesu SP-101 or SP-6.....	\$45.99
PNE-GPH-Y2K	For Yaesu SP-2000.....	\$42.99
PNE-GPH-X90	For Yaesu SP-9000.....	\$44.99
PNE-GPH-I34	For Icom SP-20, SP-34.....	\$39.99

*Earlier, aluminum face SP-23 model only.



Oscar Overhead Sphere Speaker

Give your shack an out-of-this-world space-age look plus a winning audio setup with Phonema's Oscar Overhead Sphere Speaker. Hung above the radio desk like an orbiting Oscar, the high-performance 8 Ω, 25W speaker (7.1" diameter, 4 lbs.) has been designed to envelope the listener in sound, creating a unique, warm audio experience that can both improve mental concentration on signals and reduce fatigue. The directivity of the speaker allows the audio to be concentrated in a 57 degree beam, limiting the travel of radio sounds beyond the shack. It's also a great solution if you've run out of room for a speaker to be placed on a desk or shelf. A very cool choice for hearing weak CW signals, comfortable listening in any mode, or enjoying crystal clear sounds of broadcast radio—courtesy of DX Engineering, the exclusive North American dealer of Phonema products.



PNE-OSCAR-1	Oscar Overhead Sphere Speaker.....	\$179.99
-------------	------------------------------------	-----------------

YAESU

Mobile External Speakers

Rugged and compact, these handy speakers let you put your audio where you want it. They're a great solution to less-than-ideal radio installations, because you don't have to rely on the radio's own, built-in speaker. Each speaker comes with an attached 6.5' cable that terminates in a standard 1/8" phono plug. Mounting brackets are included. Got a station on your boat? The MLS-200-M10 is waterproof. The speakers are compatible with any radio that has a 1/8" external speaker jack.



YSU-MLS-100	Mobile External Speaker, Rectangle.....	\$49.99
YSU-MLS-200-M10	Mobile External Speaker, Round, for FTM-100/400DR.....	\$49.99



Miranda S Speaker

Phonema's Miranda S speaker is sized (6.024" W x 3.976" H x 10.039" D) to perfectly complement a range of radios from Icom, Kenwood, Ten Tec, Yaesu, and others. The finely finished wood enclosure houses special acoustic damping material, 10 watt power handling and 8 Ω driver. The Miranda boasts a 80-18000 Hz frequency response and 83 dB sensitivity. This great looking and sounding speaker offers a rich and articulate sound that makes it easy to understand both voice and CW signals.



PNE-MIRANDA-S	Miranda Speaker for Icom, Kenwood, Ten Tec and Yaesu.....	\$191.99
---------------	---	-----------------

KSP3 Speaker for Elecraft K3 and K3S

Specially designed to work with and complement Elecraft K3 and K3S transceivers, the 30W KSP3 Speaker from Phonema uses a robust neodymium driver that's capable of handling higher power levels, providing a clearer and more balanced sound, improved CW signals, enhanced SSB clarity between 1 and 3 kHz, and a wider bass range for an overall more pleasant listening experience. The speaker (5.98" x 3.70" x 10.28") is sealed and wrapped in a new multi-density box with AG150, TF25R and Basotect internal acoustic foam for the best possible sound. The speaker's built-in stand matches elevation angles with the K3 and K3S and works with many other transceivers with a top-to-bottom height between 3.39" and 3.78".



PNE-KSP3S	Speaker for Elecraft K3 and K3S.....	\$192.99
-----------	--------------------------------------	-----------------

YAESU

Base Station External Speakers

These external speakers offer adjustable audio filters for fine-tuning your audio. They have dual sets of inputs, so you can match one speaker to two radios. Though they're tailored to Yaesu radio models, they work well for any base station radio.



YSU-SP-2000	Base Station Speaker for FTDX-3000/5000.....	\$219.99
YSU-SP-9000	Base Station Speaker for FTDX-9000.....	\$369.99
YSU-SP-101	Base Station Speaker for FTdx-101D.....	\$219.99

YAESU

SP-10, SP-20, SP-30, and SP-40 External Speakers

Capable of stunning audio reproduction well tailored to SSB and digital voice, these two all-new speakers from Yaesu are an excellent complement to your base station. Both speakers mate perfectly with a corresponding Yaesu transceiver.



YSU-SP-10	Speaker for Yaesu FT-991.....	\$169.99
YSU-SP-20	External Speaker for Yaesu FTDX1200, FTDX3000D.....	\$209.99
YSU-SP-30	External Speaker for Yaesu FTDX10.....	\$179.99
YSU-SP-40	External Replacement Speaker for FT-710-AESS/FIELD.....	\$149.99

Need help with your project? Call the tech line at 330-572-3200!

New!



O3A-40-NC-1

NC-1 Noise-Canceling Headset and Accessories

From 403A comes the premium NC-1 headset that's ideal whether you're into contesting or high-fidelity listening of your favorite music. The light and comfortable NC-1 features over-the-ear stereo Bluetooth headphones that upgrade with a plug-in condenser boom microphone; its preamp works with most transceivers. Enjoy crystal clear audio for contesting, wide frequency response, a top-notch 25 dB noise canceling system, 40mm neodymium drivers that reproduce the slightest details in signals and music, Bluetooth 5.0 and an internal microphone for mobile devices, a USB-C cable, and internal rechargeable 750 mAh Li-Ion battery for up to 30 hours of worry-free operation. Headphone and boom mic also sold separately. Headset-Transceiver 8-pin round mic adapters and audio adapters sold separately. **Enter "NC-1" at DXEngineering.com for more details.**

O3A-40-NC-BTNC1

- O3A-40-NC-1 NC-1 Headset Set w/Noise-Canceling Bluetooth Headphones, MC-1 Plug-In Boom Mic, Adapters, Cases; **\$393.98**
- O3A-40-NC-HP Noise-Canceling Bluetooth Headphones Only w/Case.... **\$321.99**
- O3A-40-NC-MC1 Boom Mic Only, Plug-In w/Mic & HP 3.5mm TRS Plugs, 6.35mm HP Adapter, Case **\$71.99**
- O3A-40-NC-1-I8 Headset-Transceiver Adapter Cable, 8-Pin Round for Icom..... **\$33.99**
- O3A-40-NC-1-K8 Headset-Transceiver Adapter Cable, 8-Pin Round for Kenwood..... **\$33.99**
- O3A-40-NC-1-Y8 Headset-Transceiver Adapter Cable, 8-Pin Round for Yaesu..... **\$33.99**
- O3A-40-NC-BTNC1 USB Bluetooth Adapter Dongle to Use NC-1 Wirelessly on PC **\$20.99**
- O3A-40-NC-BTNC1R USB Bluetooth Adapter Dongle + Antenna, Extended Range..... **\$31.99**



External Speakers

You've spent a lot of time and money perfecting your antenna and radio, now make sure that the last step—the audio delivery—has the same performance. Icom offers several speakers to help you better hear contacts and make more QSOs. Each speaker includes the appropriate hookup cable(s).

ICO-SP-38



ICO-SP-30

- ICO-SP-41 External Speaker, IC-7610 Companion **\$269.99**
- ICO-SP-38 External Speaker, Base Station Type, IC-7300/IC-9700 Companion..... **\$186.99**
- ICO-SP-30 External Speaker, Powered, 20 W..... **\$109.99**
- ICO-SP-35 External Mobile Speaker, Replaces SP-10 **\$59.99**



HP-1 Wired Stereo Headphones

Made for rag chewing, contesting, or just listening to your favorite tunes, bhi's HP-1 compact wired stereo over-the-ear headphones offer features that provide hours of comfort. These are lightweight, closed back foldable dynamic headphones with an adjustable headband. Soft leatherette padded earcups eliminate the pressure associated with heavy headphones, so you can operate longer without fatigue. Other features include 32 Ω impedance, high sensitivity, frequency response of 20-20,000 Hz, and 6' cable terminated with an integral 3.5mm (1/8") stereo plug, 1/4" stereo to 3.5mm stereo adapter included.

- BHD-HP-1 HP-1 Wired Stereo Headphones..... **\$33.99**



NCH Active Noise Cancelling Headphones

These headphones reduce ambient background noise and provide stellar passive audio isolation so you can enjoy a more blissful listening experience, whether in an aircraft cabin or at home trying to block out the sound of a fan or air conditioner. Weighing less than half a pound, these over-the-ear headphones feature soft pads and adjustable headband for a comfortable fit. They boast active noise cancelling capabilities from 12-15 dB. A handy switch allows the active noise cancellation to be turned on or off. Comes with a 4 foot detachable cable. **Enter "bhi nch" at DXEngineering.com for more information.**

- BHD-NCH Active Noise Cancelling Headphones **\$55.99**



KENWOOD

Communications Headphones

With a vintage vibe that harkens back to Amateur Radio's golden era, Kenwood's Communications Headphones provide the perfect frequency response for CW, SSB, AM and FM copy. They're ideal for SWL, yet they're also plenty comfortable for long running contests when used with your Kenwood microphone.

- KWD-HS-5 Communications Headphones **\$99.99**



KENWOOD

External Speakers

Don't overlook the importance of a good external speaker in your station. After all, it's the final link in your signal chain. Kenwood borrowed from its storied history of offering high-fidelity audio components to create external speakers specifically tailored to Amateur Radio—including mobile applications.



KWD-SP-23

- KWD-KES-5 Mobile, 4 Ω, 3' Cord with Stripped Leads..... **\$59.99**
- KWD-SP-23 Base, 8 Ω, RF Shielded, Screw Terminals..... **\$113.99**
- KWD-SP-990 Base, 8 Ω, RF Shielded, Pushbutton Filters..... **\$341.99**



W1 Competition Headset

Whether you're contesting, DXing or rag chewing, INRAD's new W1 Headset comes with the features operators desire for hours of worry-free, comfortable operating. Weighing only 13 ounces, it includes cupped, over-the-ear earpieces that won't hurt after hours of use; thick rubberized foam padding at the top of the headband that molds to the head; the ability to tilt the headband back up to 30 degrees without moving the earpieces; large diaphragm high response speakers for clear articulation of receive audio; 600 Ω dynamic microphone element on adjustable long boom with exceptional transmit audio; and extra long 7' cable. Connect the 1/8" mono transmit audio jack on the headset to an INRAD M-series mic jack adapter and you're ready to operate for long sessions, without troubling fatigue.



- INR-W1 Competition Headset **\$189.00**



Hi-Rate2 Headset and Footswitch Packages

Here's a great combo sure to help you make more QSOs whether contesting or working DX! The upgraded Hi-Rate2 package includes an improved commercial-grade lightweight and comfortable stereo headset with a sensitive electret boom microphone and foam windscreen to reduce breath popping noise; a ruggedly built and easy-to-activate "push-to-talk" footswitch that provides worry-free operating; cable assemblies; and transceiver mic adapter. With your hands free, you can enter call signs and reports on the keyboard, while switching from receive to transmit by depressing the footswitch. Six packages based on mic connector are available.

- PDN-HI-RATE2YA8R Yaesu 8-Pin Round Mic Connector..... **\$125.00**
- PDN-HI-RATE2YARJ Yaesu 8-Pin RJ45 Modular Mic Connector..... **\$125.00**
- PDN-HI-RATE2ELCR Elecraft 8-Pin Round Mic Connector..... **\$125.00**
- PDN-HI-RATE2ICRJ Icom 8-Pin RJ45 Modular Mic Connector..... **\$125.00**
- PDN-HI-RATE2IC8R Icom 8-Pin Round Mic Connector..... **\$125.00**
- PDN-HI-RATE2KNWD Kenwood 8-Pin Round Mic Connector..... **\$125.00**



Pistol Grip Hand Switch

This ergonomic switch lets you key your transceiver when using a microphone that doesn't have a PTT switch or when noisy environments render VOX operation impossible. It installs easily, terminating in a 1/4" phono plug.



- HLS-HS-2 Pistol Grip Hand Switch..... **\$35.00**

Orders by 10 pm ET ship the same day. See pg. 74 for details.



Pro 7 Headsets

Using well-insulated ear pads and an innovative acoustic design, the Pro 7 Headsets' passive noise cancelling ability blocks out all the background noise, leaving just you and your radio. And since it's passive, you don't have to worry about eating batteries or any extra power draw. The Pro 7 series features a unique audio balance control, which allows one speaker's volume to be adjusted. The headsets' clever phase reversal switch lets you really dig out weak frequencies, and the mic boom can be used on either the right or left ear. Pro 7 models require AD-1 series cable (sold separately); see table on page 23.

HLS-PRO7BK	Pro 7 Headset, Black, Dynamic.....	\$299.00
HLS-PRO7BK-IC	Pro 7 Headset, Black, Electret	\$299.00
HLS-PRO7BU	Pro 7 Headset, Blue, Dynamic	\$299.00
HLS-PRO7BU-IC	Pro 7 Headset, Blue, Electret	\$299.00

Pro 7 Contest/DX Element

If you've got a Pro 7 headset and do a lot of contesting, you may want to swap out the stock mic element for this purpose-built unit. It's a modified version of the venerable HC-4 element, with a sharp roll-off at 600 Hz and a 10 dB boost between 2.5-3 kHz. Those tweaks allow for clear, articulate voice reproduction that works well in busting through pileups.

HLS-PRO74-DYNELE	Pro 7 Contest/DX Element	\$69.00
------------------	--------------------------------	----------------

Pro Micro Headsets

You'll typically find these headsets in commercial broadcast environments, thanks to their specially tuned HC-6 mic element. The headsets' unique mic characteristics and durable construction also make them an excellent choice for Ham Radio. Pro Micro Headsets include a microphone windscreen and single-side mono earphone. Pro Micro models require AD-1 series cable (sold separately); see table on page 24.

HLS-PMS-6	Pro Micro Headset, Single Side.....	\$79.00
HLS-PMS-IC	Pro Micro IC Headset, Single Side.....	\$89.00

Pro Set Headsets

Designed for Amateur Radio, the lightweight and versatile Pro Set Headsets work well in any shack setup. They feature Heil Sound's exclusive phase reversal switch, which can significantly improve copy during pileups.

Pro Set Elite Headsets take comfort and performance up a notch, with larger, more heavily padded earpieces. Pro Set models require AD-1 series cable (sold separately); see table on page 24.

HLS-PS-6	Pro Set Headset	\$169.00
HLS-PS-IC	Pro Set IC Headset	\$169.00
HLS-PSE-6	Pro Set Elite Headset	\$199.00
HLS-PSE-IC	Pro Set Elite IC Headset.....	\$199.00



BM-17 Emergency Communication Headsets

Any Amateur Radio operator who has ever been in the maelstrom of an emergency operation knows the value of a quality headset. Heil Sound's BM-17 series headsets have been built with urgent communications in mind, but are also great companions in the shack for whatever you have on your agenda. First, their lightweight but solid construction is ideal for keeping you comfortable, and the swivel-mounted boom makes moving the microphone in any position easy. The BM-17 features extremely sensitive speakers that don't require much AF drive from the transceiver; a frequency response of 200Hz-5kHz; and low distortion. The two BM-17 Dynamic versions come with a 500 Ω dynamic element (operating frequency response of 120Hz-10kHz). Two other models employ an electret element (operating frequency response of 35Hz-12kHz) for use with Icom radios to eliminate the low gain audio on some older and non-pro series rigs. Single and dual headphone versions available. Requires AD-1 series cable (sold separately); see table on page 24.

HLS-BM-17D-DYN	Boom Mic Dual Headphone w/Dynamic Element.....	\$149.00
HLS-BM-17D-IC	Boom Mic Dual Headphone for Icom	\$149.00
HLS-BM-17S-DYN	Boom Mic Single Headphone w/Dynamic Element	\$139.00
HLS-BM-17S-IC	Boom Mic Single Headphone for Icom	\$139.00



DXE-FS-001

DXE-FS-002

DXE-FS-003



Footswitches

Go hands-free and speed up your operating. These new PTT footswitches from DX Engineering blend performance and value. You have three options: a budget friendly rugged plastic model, the stalwart cast iron version, and a new style with an extra-wide pedal—perfect for enthusiastic stomps.

DXE-FS-001	Footswitch, Plastic.....	\$65.99
DXE-FS-002	Footswitch, Iron.....	\$101.99
DXE-FS-003	Footswitch, Wide Pedal	\$181.99

Professional Headphones

Whether you're listening to a distant shortwave broadcast or an old jazz LP, these headphones deliver exceptional sound reproduction. They include three different detachable cables, allowing you to select the correct length and connector you'll need. The cables terminate in an iPod/iPad-compatible 1/8" plug with a gold plated, screw-on 1/4" adapter. The replaceable earpieces are heavily padded for comfort.

HLS-PROSET-3	Professional Headphones.....	\$129.00
--------------	------------------------------	-----------------



Pro Set Media Pro Headset

Made to work specifically with your computer, this award-winning headset delivers beautiful articulate audio. The earphones are acoustically tuned and use Heil Sound's exclusive phase-reversing feature to create a spatial widening effect that makes audio easier to hear. The mic element is also tailored to sound card input requirements.

Pro Set Media Pro Headsets are plug-and-play, with two standard 1/8" plugs that connect to the microphone and speaker jacks of your computer.

HLS-PSM	Pro Set Media Pro Headset	\$119.00
---------	---------------------------------	-----------------



Lightweight Dual-Side Boomset

Weighing a mere 3 ounces, this headset is perfect for contesting, Field Day and any portable operation. It has an extremely sensitive mic element that draws very little power, making it great for QRP rigs. The cable has an integrated PTT switch, adding to the headset's versatility. The Dual-Side Boomset requires AD-1 series cable (sold separately); see table on page 24.

HLS-BM-10-DYN	Lightweight Dual-Side Boomset	\$149.00
---------------	-------------------------------------	-----------------



Handie-Talkie Headsets

Designed precisely for Amateur Radio handhelds, these Heil headsets let you work hands-free in the field. The slim, low profile design is discreet and lightweight, which means the headsets can be worn comfortably for hours. The single earpiece can be positioned on the left or right side. The headsets have a standard PTT switch. Select the one appropriate for your radio model below.

HLS-HTH-I	HT Headset for Icom 2-Pin Plug	\$35.00
HLS-HTH-K	HT Headset for Kenwood 2-Pin Plug	\$35.00
HLS-HTH-Y	HT Headset for Yaesu TRRS Plug.....	\$35.00

Dual-Sided Handie-Talkie Headsets

HLS-HTHD-I	Dual-Sided HT Headset for Icom 2-Pin Plug	\$39.00
HLS-HTHD-K	Dual-Sided HT Headset for Kenwood 2-Pin Plug	\$39.00
HLS-HTHD-Y	Dual-Sided HT Headset for Yaesu TRRS Plug.....	\$39.00

HLS-HTH-I



Need advice? 1-330-572-3200 or DXEngineering@DXEngineering.com

24 Audio Accessories

Cables and Adapters

These assemblies let you connect your Heil Sound mics and accessories to your transceiver. Depending on the application, they include the manufacturer-specific plugs for your mic/headset, PTT switch and transceiver. If you need help choosing the right adapter, visit DXEngineering.com, select your mic or headset, and the "suggested parts" tab will show you some options.

Part Number	Description	Price
Icom		
HLS-AD-1-I	Pro Set 8-Pin Adapter Cable	\$27.00
HLS-AD-1-IHT	Headset Adapter Cable for IC-705/HTs	\$27.00
HLS-AD-1-IM	Pro Set Modular Adapter Cable	\$27.00
HLS-AD-1-IC	Pro Set 8-Pin Adapter Cable	\$27.00
HLS-AD-1-ICM	Pro Set Modular Adapter Cable	\$27.00
HLS-CC-1-I	XLR4 to 8-Pin Mic Cable	\$40.00
HLS-CC-1-IM	XLR4 to Modular Mic Cable	\$40.00
HLS-CC-1-XLR-I	XLR3 to 8-Pin Mic Cable	\$40.00
HLS-HSTA-IC8	Traveler Headset Adapter, Icom 8-Pin	\$19.00
HLS-HSTA-IM	Traveler Headset Adapter, Icom Modular	\$19.00
Kenwood		
HLS-AD-1-K	Pro Set 8-Pin Adapter Cable	\$27.00
HLS-AD-1-KM	Pro Set Modular Adapter Cable	\$27.00
HLS-CC-1-K	XLR4 to 8-Pin Mic Cable	\$40.00
HLS-CC-1-K4	XLR4 to 4-Pin Mic Cable	\$40.00
HLS-CC-1-XLR-K	XLR3 to 8-Pin Mic Cable	\$40.00
HLS-HSTA-KM	Traveler Headset Adapter, Kenwood Modular	\$19.00
HLS-HTA-KHT	Traveler Headset Adapter, Kenwood HT Dual Plug	\$19.00
Yaesu		
HLS-AD-1-Y	Pro Set 8-Pin Adapter Cable	\$27.00
HLS-AD-1-YM	Pro Set Modular Adapter Cable	\$27.00
HLS-CC-1-Y	XLR4 to 8-Pin Mic Cable	\$40.00
HLS-CC-1-YM	XLR4 to RJ45 Modular Mic Cable	\$40.00
HLS-CC-1-XLR-YB	XLR3 to 8-Pin Mic Cable, PTT Connector	\$40.00
HLS-CC-1-XLR-YM	XLR3 to 8-Pin Modular, Balanced	\$40.00
HLS-AD-100	Yaesu 8-Pin Round to 6-Pin Modular Adapter	\$27.00
HLS-ADMY-817	Yaesu 8-Pin Mic to FT-817-450 Modular Adapter (-897,-991)	\$30.00
HLS-HSTA-YM	Traveler Headset Adapter, Yaesu 8-Pin Modular, RJ45	\$19.00
Miscellaneous		
HLS-AD-1-C	Headset Adapter, Collins/Drake, 3/16" Plug, 1/4" Jack	\$30.00
HLS-AD-1-T	Headset Adapter, TEN-TEC, 4-Pin, 1/4" Jack	\$27.00
HLS-CC-1-C	Microphone Adapter, Collins/Drake, 4-Pin to XLR4	\$49.00
HLS-CC-1-XLR-3	Mic Cable with Connectors, 3-Pin XLR Male to Female, 8'	\$40.00
HLS-CC-1-XLR-4	Mic Cable Adapter, for XLR4 HM/GM Mics to XLR3	\$40.00

HEIL
HAM RADIO



HLS-AD-1-IC



HLS-CC-1-I



HLS-CC-1-IM



HLS-AD-1-K



HLS-CH-1-KM



HLS-HTA-KHT



HLS-AD-1-YM



HLS-CC-1-XLR-3



HLS-CC-1-XLR-4



HLS-WSPS

HLS-HMCLIP

HEIL
HAM RADIO

HLS-XT-1

Genuine Heil Parts and Accessories

If you want to give your mic or headset a tune-up, then Heil Sound offers you accessories and replacement parts to do it. If you're looking for a specific part, don't hesitate to let us know and we'll do our best to find it for you.

Part Number	Description	Price
HLS-BAG1	Headset Gear Bag for Pro Set	\$29.00
HLS-BC	Boom Clip for Pro Set	\$7.00
HLS-PS-EPC	Ear Pad Covers for Pro Set (Pair)	\$9.95
HLS-EP-FOAM-PS	Foam for Pro Set Ear Pads (Pair)	\$4.95
HLS-EP-PSP	Ear Pads for Pro Set Plus/Elite (Pair)	\$10.00
HLS-EP-PS	Ear Pads for Pro Set Series (Pair)	\$10.00
HLS-EP-BM-BLACK	Ear Pads for BM Series (Pair)	\$8.95
HLS-HMCLIP	Clip for GM/HM/PR Mics, 5/8"-27 Thread	\$10.00
HLS-WSHM	Windscreen for Handi Mic Series	\$6.00
HLS-WSM	Windscreen for PR 20/35 and GM Mic	\$6.95
HLS-WSPS	Windscreen for Pro Set Mic	\$6.00
HLS-WSPSP	Windscreen for Pro Set Plus Mic	\$6.00
HLS-XT-1	High-to-Low Impedance Matching Transformer	\$19.00
HLS-HC51RETROKIT	Mic Element Upgrade Kit	\$69.00

YAESU

YSU-SSM-63A

Headsets and Earpieces

Don't be saddled with your HT all day. Grab one of these headsets or earpieces and work hands-free. Select from a traditional lightweight mono headset with a boom mic, or a low-profile earset. Each option has an inline PTT switch, and the smaller earpieces include a handy lapel clip to keep the controls close at hand. Select the one you want based on your Yaesu radio model below.

YSU-SSM-63A	VOX Headset for FT-1/2DR, FT-60R, VX-3R	\$69.99
YSU-SSM-518A	Earpiece Lapel Mic for VX-6R/FT-270	\$39.99
YSU-SSM-518A	Earpiece Lapel Mic for FT-1/2/3/5DR, VX-3R, FT-60R	\$39.99
YSU-SSM-517A	VX6R/FT270	\$41.99

Lightweight Stereo Headphones

Just listening tonight? Here's the perfect set of headphones. These comfy "cans" supply excellent sound reproduction. They come with a 4' audio cord and include a handy 1/8" phono to 1/4" phono jack adapter.

YSU-YH-77STA	Lightweight Stereo Headphones	\$99.99
--------------	-------------------------------------	---------



DXEngineering.com

We're always adding and developing innovative products that improve your on-air experience. Find the hottest new gear (including all the latest stuff that we couldn't cram into this catalog) at DXEngineering.com. Our website's tech support section has a comprehensive FAQ, a reference library filled with tech articles and free downloadable instruction manuals. Remember, if you've got a nagging issue with your station, you can always contact us via phone or email for solutions. Like to save money? DXEngineering.com's "Hot Deals" section is packed with weekly specials and deeply discounted products. Check back weekly to see what's on sale.

We're All Elmers Here! Get Expert Support at: Elmer@DXEngineering.com



Microphone Booms and Riser

Don't put your prized microphone on anything less than a professional-grade Heil Sound Boom. These quiet booms are sturdy and durable enough to go in the most active Ham shacks and sound studios. All booms are threaded to accept standard mic accessories and are the perfect compliment to your Heil Sound Microphone. The Riser is a great solution for mounting your boom behind your transceiver.

- HLS-PL2T Topless Proline Microphone Boom **\$115.00**
- HLS-HB-1 Large, Articulated Microphone Boom **\$79.00**
- HLS-SB-2 Straight Boom, 17" with Stealth C-Clamp **\$69.00**
- HLS-RS1 Boom Riser **\$49.00**
- HLS-FL-2 Flange Mount **\$29.00**
- HLS-DT1 Desktop Flush Mount **\$39.00**
- HLS-WM1 Vertical Surface Mount **\$29.00**
- HLS-PL2CLAMPR Replacement Mount for PL2T/SB-2/HB-1 **\$19.95**

Shock Mount

Using an 8-point suspension support system, these mounts fight off low frequency rumble and absorb noise caused by vibration and impact. The SM-1 is designed for slim-line Heil Sound microphones' 1" stem, while the PRSM is tailored to larger diaphragm professional-grade mics' 2" stem. It's important to check your microphone's fit before ordering.

- HLS-SM-1 Shock Mount **\$79.00**
- HLS-PRSM-B Shock Mount, Black Finish **\$99.00**

Gold Elite Microphone

Heil Sound specifically crafts this microphone for the Ham radio community. The microphone includes two distinct dynamic elements, selectable with the flip of a switch. The "Wide" setting is ideal for general voice articulation. The "Narrow" setting accentuates the lower frequency range of human voice to help smooth out the audio response. This mic uses a 4-Pin XLR plug.

- HLS-GM-ELITE Gold Elite Microphone **\$159.00**

iCM Microphone

Owners of early Icom transceivers know that they don't have a lot of gain in the microphone preamp stage. Heil Sound gives you a boost with a mic specifically suited to those transceivers. Heil Sound worked closely with Icom engineers to build a mic with an excellent frequency response, coupled with a higher output to compensate for the lack of gain in early Icom transceivers. Includes cable with 8-Pin round mic connector.

- HLS-ICM iCM Microphone **\$135.00**

Microphone Base Stand

Improving upon a timeless design, these heavy, polished chrome bases include a PTT switch that can also be used as a "cough" switch. It uses standard mic mounting threads and a 24" jumper cable is included to make mic installation a breeze.

- HLS-CB-1-PTT Microphone Base Stand **\$79.00**

PR 781 Microphones

Heil gives you a professional-quality microphone that will provide years of service in your shack. Building upon the legendary PR 780, these dynamic cardioid microphones feature a wide frequency response that retains the signature Heil Sound voice articulation.

The PR 781 works well with practically any high-quality transceiver. In fact, you'll find these same mics used in many commercial broadcast studios. This mic uses a 3-Pin XLR plug.

- HLS-PR781 PR 781 Mic, Black Screen **\$209.00**
- HLS-PR781G PR 781 Mic, Gold Screen **\$209.00**

PR 40 Microphone

With the widest frequency range of any dynamic mic in the PR series, this microphone is the workhorse of professional sound recording studios. It features a shock-mounted, low mass diaphragm, which gives you stellar sound reproduction in a durable chassis. An internal filter prevents dreaded breath blast and cuts down on P-pops, too. This microphone is simply one of the best all-around mics for audio engineers and Ham operators alike. This mic uses a 3-Pin XLR plug.

- HLS-PR40 PR 40 Microphone **\$349.00**
- HLS-PR40B PR 40 Microphone, Black **\$349.00**

PR 77D Microphone

Give your shack the same professional-quality dynamic microphone enjoyed by commercial broadcasters, podcasters, performers, recording artists, and anyone who demands a smooth, flat response over a wide frequency range. The PR 77D delivers excellent transient response, great speech articulation, and low IMD. Take advantage of 180-degree, off-axis rear rejection of over 40 dB, a bass EQ switch, and a front pattern that allows you to move about freely in front of the element with no change in response. A CC-1 XLR cable is required to interface with Amateur Radio rigs.

- HLS-PR77D Wide Range Dynamic Microphone, Black **\$249.00**
- HLS-PR77DP Wide Range Dynamic Microphone, Purple **\$249.00**

Handi Mic Microphones

These mics are the answer to muffled audio response. Well-suited to Amateur Radio use, they capture crisp, clean and articulate audio. Their rugged internal shock mount makes them a durable addition to your shack. They also feature low noise handling characteristics, making them great for use in mobile or field applications. A dash/wall mount and windscreens are included. This mic uses a 4-Pin XLR plug. The Handi Mic iC uses a high-performance output specifically tailored to Icom transceivers. The Handi Mic Pro contains the wide-range broadcast element, ideal for VHF FM rigs.

- HLS-HM-IC Handi Mic iC **\$89.00**
- HLS-HM-PRO Handi Mic Pro **\$89.00**

Microphones

Transmit with clarity with top-quality microphones from DX Engineering. Our microphones deliver clear communication with excellent frequency response, which makes them perfect for radio communication. We've got mics designed specifically for base stations and others that are well suited for field communication. Browse our inventory of leading-brand microphones from Heil Sound, Kenwood, Yaesu, ICOM, and more to find the perfect solution for your audio needs.

- HLS-HMM Heil Sound Microphone **\$84.00**
- HLS-HMM-IC Heil Sound Microphone **\$84.00**



YAESU

Reference Microphone

Yaesu purpose-built this microphone to deliver the ultimate in Amateur Radio voice reproduction. It combines both an electret condenser and dynamic mic element, selectable separately or combined with independent adjustability to suit your unique voice characteristics.

The mic base incorporates a recorder/playback module to check out audio, plus a large graphic EQ and frequency response scope. Large buttons allow for near limitless adjustability. The mic itself can be fitted with the cowl to increase treble output. It can be configured for an 8-Pin round or modular connector.

- YSU-M-1 Reference Microphone **\$671.99**

Dual Element Desk Microphone

Yaesu's M-100 packs in all the audio performance of the M1 (without the equalizer and display features). It supports a wide range of Yaesu rigs, including the FTDX 9000, FTDX 5000, FTDX 3000, FTDX 1200, FT-991A, FT-891 and FT-450 Series. Recommended for all voice modes from SSB to C4FM, the M-100 can be operated with punchy transmit audio for effective DXing and contesting. Other features include a dynamic element and condenser (electret) element, air cylinder/magnetic switch for effortless PTT, manually selectable low and high cut, and a pedestal-base mount for isolated vibration and purer sound.

- YSU-M-100 Dual Element Desk Microphone **\$439.95**



Microphone and RJ12/RJ45 Extension Cables

Choose these high-quality extension cables from Consolidated Wire for making reliable station connections every time. Microphone extension cables are universal for all brands.

- CEW-GX16-5S Mic to Transceiver, 8-Pin Round Foster Male to Female, 5' ... **\$17.99**
- CEW-GX16-10S Mic to Transceiver, 8-Pin Round Foster Male to Female, 10' . **\$21.99**
- CEW-GX16-15S Mic to Transceiver, 8-Pin Round Foster Male to Female, 15' . **\$26.99**
- CEW-RJ12EXT RJ12, Male to Female 6-Pin Modular Mic or Control, 15' **\$12.50**
- CEW-RJ45EXT 8-Pin Modular Mic, Ethernet, RJ45 Male to RJ45 Female, CAT 5E, Pair, 15' **\$14.29**

Visit DXEngineering.com for the latest limited-time offers and special savings!



Microphones

No matter which you choose, INRAD's line of quality microphones delivers performance and value for Hams at every level. Each one has its own specialized dynamic element and unique style. They all come with a 3-Pin XLR to 1/8" adapter cable for easy hookup. Certain radios may require an additional adapter, see below.

M629

Tailored to modern radios including the latest SDRs, the M629 has a brilliant cardioid dynamic element with excellent frequency response.

INR-M629 M629 Microphone **\$79.00**

M650

One of INRAD's most popular mics, with audio response similar to the M628 and M686. It has a cardioid element and internal breath screen.

INR-M650 M650 Microphone **\$79.00**

M686

Excellent transmit audio, reminiscent of the M629 and M650, with a black metal frame, cardioid element, and internal breath screen.

INR-M686 M686 Microphone **\$69.00**

M665

Retro chrome look and uni-directional element with bright mid-range and a built-in filter to mitigate breath noise and P-pops.

INR-M665 M665 Microphone **\$69.00**

M628

Value-priced counterpart to the M650, boasting a similar cardioid element with a focused 40 Hz to 15 kHz response that's well suited to SSB.

INR-M628 M628 Microphone **\$59.00**

ICOM Desktop Microphones

Here are the perfect microphones for your Icom base radio. They're unidirectional and ideal for SSB and FM voice operation. Each mic features a PTT button with PTT Lock switch, adjustable mic output, and a low-cut switch. Both mics terminate in an Icom 8-Pin round female plug. There's a dynamic or an electric condenser mic option; select the one that best suits your operating style and environment—if you don't know, call us and we can help.



ICO-SM-30

ICO-SM-30 Desktop Microphone, Electret Condenser **\$169.99**

ICO-SM-50 Desktop Microphone, Dynamic **\$335.99**

DXEngineering.com

We're always adding and developing innovative products that improve your on-air experience. Find the hottest new gear (including all the latest stuff that we couldn't cram into this catalog) at DXEngineering.com.



DMS-628-Y



Desk Microphone Systems

Get everything you need in one convenient package! The INRAD Desk Microphone System combines the company's best dynamic microphones with its heavy DMS-1 PTT desk stand and a transceiver adapter cable with coiled cord that connects from the back of the base to your transceiver mic jack. Packages come with INRAD's M628, M629, M650, M665, or M686 microphone, and your choice of four adapter cables for Icom, Yaesu, Kenwood, Elecraft and TenTec transceivers.

INR-DMS-628_	M628 Mic, PTT Desk Stand, Adapter Cable	\$161.90
INR-DMS-629_	M629 Mic, PTT Desk Stand, Adapter Cable	\$181.90
INR-DMS-650_	M650 Mic, PTT Desk Stand, Adapter Cable	\$181.90
INR-DMS-665_	M665 Mic, PTT Desk Stand, Adapter Cable	\$171.90
INR-DMS-686_	M686 Mic, PTT Desk Stand, Adapter Cable	\$171.90



PTT Desk Stand

Built for INRAD microphones and other standard stage mics with 1 inch bodies, this great-looking PTT desk stand features a large push-to-talk bar switch that lets you comfortably execute long transmissions by locking it in place. Simply slide the switch to the right to release. The stand's hefty 2 1/2 lb. metal base keeps it from sliding, and a rubberized clip makes mounting your microphone easy. A circular rubber ring in the threaded base for the standpipe and mic clip provides an integral shock mount for noise isolation. The back of the DMS-1 base has a 1/8" jack (3.5mm female) for the audio from the microphone and a 4-pin XLR male output to deliver the audio and PTT from the PTT Desk Stand to the transceiver. Choose one required INRAD coiled cord adapter cable terminated with 4-Pin XLR female and a specific transceiver microphone female connector.



INR-DMS-1	PTT Desk Stand	\$85.95
INR-DM-I	INRAD DMS-1 Adapter Cable for Icom 8-Pin Round Mic Input	\$16.95
INR-DM-K	INRAD DMS-1 Adapter Cable for Kenwood 8-Pin Round Mic Input	\$16.95
INR-DM-Y	INRAD DMS-1 Adapter Cable for Yaesu 8-Pin Round Mic Input	\$16.95
INR-DM-YM	INRAD DMS-1 Adapter Cable for Yaesu 8-Pin Modular Mic Input	\$16.95



Heil Wire Bulk Microphone Cable

Specifically designed for mics, switches, keys, paddles and other audio/control devices, this cable consists of two 18 AWG shielded internal wires plus two 18 AWG wires external to the braid. Heil's cable is specially shielded to reduce hum, PTT pulses and RFI. It is made to fit neatly into 1/4 inch connectors and receptacles.

HLS-HW-10	Microphone Cable, 10 Feet	\$15.00
HLS-HW-20	Microphone Cable, 20 Feet	\$25.00
HLS-HW-50	Microphone Cable, 50 Feet	\$65.00

Prices are subject to change without notice.

YAESU

M-90D Desktop Microphone

Experienced hams know that a quality microphone is worth its weight in gold, which is what you'll receive with the Yaesu M-90D. It employs a finely tuned dynamic element to deliver rich low-to-mid frequency response. For hams, that means a clear and concise conversational sound great for contesting, DXing, or long rag-chews. An oversize dynamic microphone element and windscreen accentuate voice input from the front and limit ambient noise and sounds from the side. Features include a large PTT bar switch, a PTT lock button, and both 8-pin modular and round connectors at the back. By swapping the orientation of the supplied coiled cord cable with 8-pin round and modular connectors at either end, the M-90D may be used with virtually any Yaesu HF transceiver*, including the FTDX101 Series and FTDX10. For difficult band conditions, a built-in, low-cut filter creates clear and crisp audio characteristics by shaping the low frequency response (cut off at 340Hz, -6dB/octave). An integrated isolation transformer enhances its audio quality. In addition, use of three air cylinder tubes provides a lifetime of solid, smooth, and noiseless PTT operation. The M-90MS Microphone and Stand Mounting Kit includes a mic head, inline PTT hand switch, and bracket to attach to a boom or stand (not included).



*Optional Power Supply Kit ABB19X001 required for use with Yaesu FT-1000/D, FT-990, FT-890, FT-840 and FT-747 rigs.

YSU-M-90D	M-90D Desktop Microphone...	\$174.95
YSU-M-90MS	M-90D Microphone and Stand Mounting Kit	\$149.95
YSU-SCU-53	Mic Adapter Cable for M-90MS, RJ-45 Jack to Round 8-Pin Plug	\$29.95

YAESU

M-70 Desktop Microphone

Whether you're into the whole brevity thing or have the gift of gab, the M-70 makes a great addition to your Yaesu rig. It utilizes a directional condenser element with a precisely-tuned frequency response that delivers clear and crisp audio. Audio is further enhanced by an isolation transformer integrated in the circuit board. The PTT employs three air-cylinder tubes, similar to the M-1 model, to provide solid and smooth extended operation. A simple one-touch PTT keylock button is placed just above the PTT key for long rag-chews. The M-70 is compatible with all Yaesu HF transceivers equipped with round 8-pin microphone connector or 8-pin modular microphone connector.



YSU-M-70 M-70 Desktop Microphone **\$144.95**



Heil Ham Radio Handbook 2nd Edition

Featuring 128 pages that are chock full of useful information, this guide penned by audio legend Bob Heil, K9EID takes readers from very basic Ham Radio principles to advanced technologies. Bob's easy, conversational style of writing for technical subjects will help you to quickly understand what radio (and audio) is all about. This handbook is an ideal primer for new Hams or those considering involvement in the hobby.

HLS-HHB Heil Ham Radio Handbook **\$20.00**





Contest University Textbooks

Couldn't make it to Dayton? These paperbacks are the same ones distributed at the annual Contest University seminars. Whether you're a seasoned contester or just becoming interested in this exciting facet of Ham radio, these textbooks are valuable additions to your library. Topics include everything from helpful tips and pointers to advanced operating methods and RF theory.

CUB-CTU-2017	2017 CTU Textbook.....	\$19.99
CUB-CTU-2018	2018 CTU Textbook.....	\$19.99
CUB-CTU-2019	2019 CTU Textbook.....	\$19.99
CUB-CTU-2022	2022 CTU Textbook.....	\$24.99
CUB-CTU-2023	2023 CTU Textbook.....	\$26.99

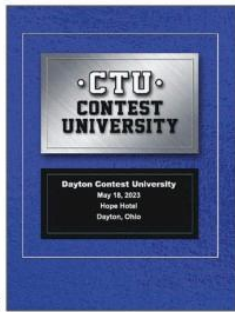

The Successful Ham Radio Operator's Handbook—Best Practices for Hams

Fred Cady, KE7X and Vic DiCiccio, VE3YT have teamed up to put together 268 spiral-bound pages of information and wisdom that is essential reading for novices and old-time Hams who are rediscovering the hobby. Topics covered include basics of how a radio works; developments such as SDR and direct sampling receivers; fun and useful aspects of Ham operation, including digital modes, weak signal VHF, public service, EMCOMM, and DXing; how to build your own dipoles and verticals; information on baluns, selecting the right coax and propagation; and much more. Want to be a successful operator? Here's a good place to start!

KEX-OPERATORBOOK The Successful Operator's Handbook **\$44.95**

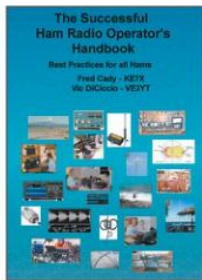

Technician and General Class License Course Books

Two of the best study guides available, these books contain everything you'll need to know to pass the licensing exam. The illustrated paperbacks offer the perfect mix of technical information and practical real-world examples.

Author Stu Turner W0STU holds an Extra Class license and also served as a U.S. Air Force Academy Engineering Professor. So he knows how to arm you with the confidence to pass the test. After you're licensed, these books are great additions to your technical library.

HDS-GENBOOK2027	General License Course, 277 Pages.....	\$22.95
HDS-TECHBOOK2026	Technician License Course, 214 Pages.....	\$22.95

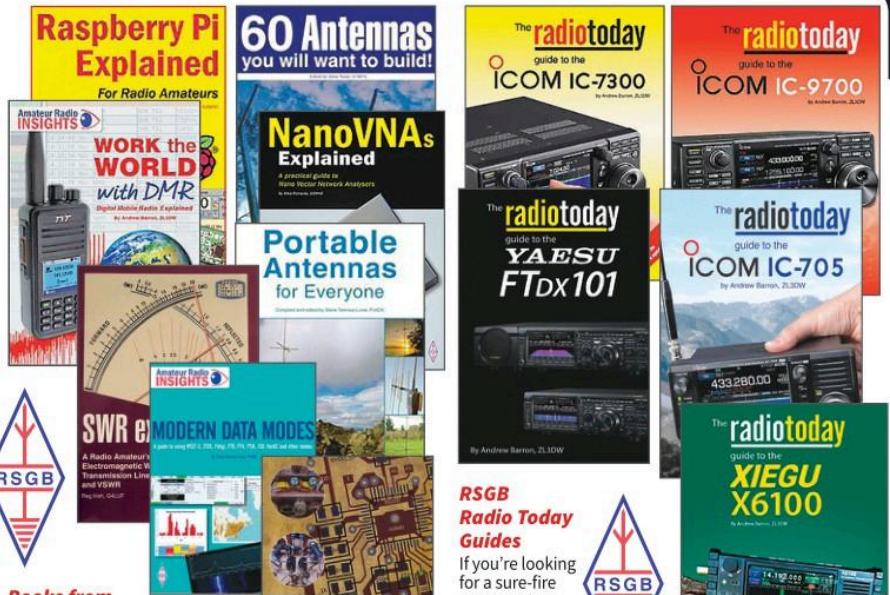
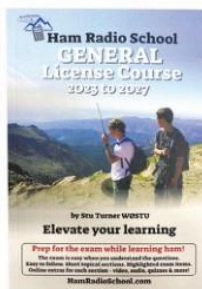

Books from the Radio Society of Great Britain (RSGB)

DX Engineering is proud to carry more than 75 ham radio reference books from the RSGB—an organization that has been advancing the art and science of amateur radio since its founding in 1913. Clearly and expertly written, RSGB's paperbacks cover a range of topics, from portable antennas to SOTA, EME to digital modes, Raspberry Pi to test equipment. A few options are below, including the 752-page RSGB Radio Communication Handbook, 15th Edition—one of amateur radio's essential guides. **Enter "RSGB" at DXEngineering.com for the full lineup.**

RSG-ANG0	60 Antennas You Will Want to Build;	\$26.99
RSG-ARA2	Amateur Radio Astronomy.....	\$28.99
RSG-ASAT	Amsats and Hamsats.....	\$25.99
RSG-BATR	Building a Transceiver.....	\$22.99
RSG-CIA3	Computers in Amateur Radio, 3rd Edition.....	\$27.99
RSG-ELE2	Elimination of Electrical Noise.....	\$13.99
RSG-GSEM	Getting Started in EME.....	\$15.99
RSG-HFDB	HF DX Basics.....	\$20.99
RSG-MAGI	The Magic Bands.....	\$27.99
RSG-MDMO	Modern Data Modes.....	\$16.99
RSG-NVNA	Nano VNAs Explained.....	\$22.99
RSG-PANT	Portable Antennas for Everyone.....	\$27.99
RSG-PARA	The Paraset Radio.....	\$15.99
RSG-PR13	Prefix Guide, 13th Edition.....	\$22.99
RSG-PSEP	Power Supplies Explained.....	\$28.99
RSG-QRP3	QRP Basics, 3rd Edition.....	\$27.99
RSG-R15H	Radio Comm. Handbook, 15th Edition, Hardback.....	\$69.99
RSG-RH15	Radio Comm. Handbook, 15th Edition, Paperback.....	\$56.99
RSG-RFDB	RF Design Basics.....	\$30.99
RSG-RPIE	Raspberry Pi Explained.....	\$27.99
RSG-RTT2	RTTY/PSK31 for the Radio Amateur;	\$15.99
RSG-SOTE	SOTA Explained.....	\$22.99
RSG-STL3	Stealth Antennas, 3rd Edition.....	\$27.99
RSG-SUWA	Successful Wire Antennas.....	\$27.99
RSG-SWRE	SWR Explained.....	\$13.99
RSG-UGPS	Using GPS in Amateur Radio.....	\$25.99
RSG-WWDM	Work the World with DMR.....	\$25.99
RSG-WWDS	Work the World with D-STAR.....	\$26.99
RSG-WWSF	Work the World w/ System Fusion.....	\$26.99
RSG-YAEX	Yagi Antennas Explained.....	\$27.99

RSGB Radio Today Guides

If you're looking for a sure-fire way to get the most out of your new transceiver, RSGB's Radio Today Guides by Andrew Barron, ZL3DW, take you far beyond what you'll find in the factory instructions. Each paperback doesn't simply repeat what's in the manual. They serve as a step-by-step "how-to-do-it" reference, covering a myriad of invaluable topics: setting up the rig, using the array of controls, operating in different modes, troubleshooting, accessing deeper menu layers, and taking advantage of new features from firmware upgrades.

RSG-RT97	Radio Today Guide to the Icom IC-9700.....	\$27.99
RSG-RT76	Radio Today Guide to the Icom IC-7610.....	\$23.99
RSG-RT73	Radio Today Guide to the Icom IC-7300.....	\$23.99
RSG-RT75	Radio Today Guide to the Icom IC-705.....	\$27.99
RSG-RT101	Radio Today Guide to the Yaesu FTdx101.....	\$27.99
RSG-RT10	Radio Today Guide to the Yaesu FTDX10.....	\$27.99
RSG-RT710	Radio Today Guide to the Yaesu FT-710.....	\$27.99
RSG-RT91	Radio Today Guide to the Yaesu FT-991A.....	\$19.99
RSG-RTX6	Radio Today Guide to the Xiegu X6100.....	\$18.99

Ham Radio Guide 2022

This spiral-bound 70-page guide is filled with useful information compiled in a single book for quick reference. Printed on strong, laminated card stock, the Ham Radio Guide by Giovanni Scavino, IK0WJM, includes updated country and prefix lists; band plans of IARU regions 1,2 and 3; a comprehensive overview of national amateur radio organizations; a fold-out world map showing all prefixes, CQ and ITU zones, time zones, and world grid locator displaying maidenhead or QTH grid squares; associations, leagues, official societies, and QSL bureaus; license reciprocity between different countries and maximum legal power by country; and much more.

WMO-35020 Ham Radio Guide 2022..... **\$55.99**

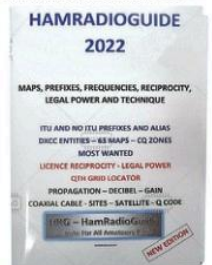

Our catalog is only the beginning! See thousands of products at DXEngineering.com

ARRL Literature

Stay up to date with the latest technological advances in our hobby. Books from the ARRL are the go-to resource for Amateur Operators of any expertise level. Build your technical library with ARRL publications.



Reference	ARR-0741 Best of the Doctor is In, Paperback	\$19.95	Educational	ARR-0079 Your First Amateur Radio HF Station	\$19.95
	ARR-1205 ARRL Operating Manual, 12th Edition	\$24.95		ARR-0823 Understanding Basic Electronics	\$29.95
	ARR-1571 ARRL Handbook 100, Collector's Edition	\$79.95		ARR-1243 Contesting for Beginners	\$24.95
	ARR-1595 Get on the Air with HF Digital, 3rd Edition;	\$22.95		ARR-1281 Microcontroller Projects	\$34.95
	ARR-1700 ARRL Handbook 100, Soft Cover Edition	\$69.95		ARR-8314 Your Introduction to Morse Code	\$15.95
	ARR-1731 Here to There Radio Wave Propagation	\$22.95	Software and Digital Modes		
	ARR-1748 The Parks on the Air Book, First Edition	\$22.95	ARR-1281 Microcontroller Projects/Amateur Radio	\$34.95	
	ARR-1854 2024 Repeater Directory	\$19.95	ARR-1472 More Arduino for Ham Radio, 384 Pages	\$34.95	
Antennas and Antenna Building			EMCOMM and HF		
ARR-0239 Even More Wire Antenna Classics, Vol. 3	\$19.95		ARR-0802 Portable Operating for Amateur Radio	\$19.95	
ARR-0789 Receiving Antennas	\$27.95		ARR-0987 Magic Band Antennas for Ham Radio	\$19.95	
ARR-0994 HF Dipole Antennas	\$19.95		ARR-1410 Storm Spotting & Amateur Radio 3rd Ed	\$19.95	
ARR-1755 Antenna Book, 25th Edition, Hard Cover	\$79.95		ARR-5439 ARES Field Resources Manual	\$12.95	
ARR-1762 Antenna Book, 25th Edition, Soft Cover	\$69.95		Log Books, Notebooks, Pocket References		
ARR-1830 Antenna Book, 25th Edition, 4 Vol. Set	\$69.95		Ditch the box-store notepads and log your contacts quickly and accurately.		
Educational			ARR-1250 Station Log Book	\$9.95	
ARR-0004 Morse Code Operating	\$15.95		ARR-7539 MINILOG Book	\$7.95	
ARR-0058 Low Bands Ham Radio, Intl. Ed. 2020	\$39.95				

Grounding and Bonding for the Radio Amateur

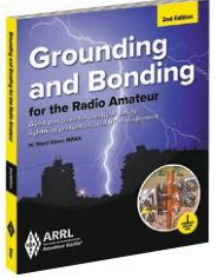

From Ward Silver, N0AX, comes the second edition of this popular amateur radio reference. It contains up-to-date content; improved drawings; and expanded coverage on key topics, including new details on grounding and bonding for portable, mobile, and upper-floor stations; routing of the ground system; routing of feedlines; and RF management. In addition to covering AC safety, there are expanded details on lightning protection, station antenna systems, single-point ground panels, and more. An essential guide to building your station with effective grounding/bonding techniques and protecting home or temporary stations, towers and antennas.

ARR-1496 Grounding and Bonding for the Radio Amateur, 2nd Edition **\$25.95**

License Manuals



For decades, Amateur Operators have trusted the ARRL License Manuals to help them pass their exams. The books include easy-to-understand lessons and a comprehensive set of sample exam questions. They're the perfect companion for the ARRL's Exam Review for Ham Radio™ online resource available for free at ARRL.org. Study guides purchased from DX Engineering always contain the current FCC question pools.

ARR-1557 Tech Class License Manual, Spiral Bound	\$32.95
ARR-1717 General Class License Manual, Spiral Bound	\$32.95
ARR-1311 Extra Class License Manual, Spiral Bound	\$32.95

ARRL Gordon West License Study Guides

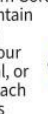

Now published by the ARRL, these comprehensive study guides by noted ham Gordon West, WB6NOA, contain all the information you need to pass your Technician, General, or Extra Class exam. Each paperback includes the current question pool (exactly as questions will appear on the exam) with explanations of why each answer is correct. Books include illustrations, diagrams, photos, and WB6NOA's unique style that makes earning your Tech license or upgrading fun and easy. Along with insights from technical editor Eric P. Nichols, KL7AJ, the guides lead you through logically organized groups of questions to help you absorb and retain information.

ARR-1908 ARRL Gordon West Tech Class Study Guide, 2022-26	\$29.95
ARR-1915 ARRL Gordon West General Class Study Guide 2023-27	\$32.95
ARR-1922 ARRL Gordon West Extra Class Study Guide 2020-24	\$32.95

Current Extra Class question pool is valid until June 30, 2024. See DXEngineering.com for new Extra Class books starting July 1, 2024.

DX ENGINEERING

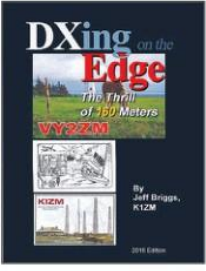

DXing on the Edge, 2nd Edition

Love 160 Meters? Author Jeff Briggs, K1ZM has compiled a new edition of his acclaimed book. It's filled with everything a diehard Topbander should know, including historical information, operating tricks and station tips. This paperback crams a ton of Top Band tidbits into 256 pages—a great read for the 160M aficionado.

DXE-DXINGBOOK DXing on the Edge Book **\$20.18**

DX ENGINEERING

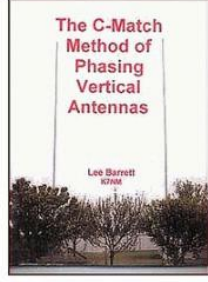

K7NM's The C-Match Method of Phasing Vertical Antennas

In this 47-page paperback, Lee Barrett, K7NM, explains the concept behind the C-Match Method and demonstrates how amateur radio operators can use it to easily phase vertical arrays. This powerful concept can be used by hams to chase rare DX stations by "pointing" their signal in the desired direction. The book includes a CD with phasing pattern programs.

KNM-VERTANTENNAS The C-Match Method of Phasing Vertical Antennas **\$19.95**

We stock many more items than we can show. See them all at DXEngineering.com!



Ham Radio for Dummies, 4th Edition

Written by Ward Silver, N0AX, the latest edition this essential reference offers expanded coverage of the ever-evolving world of ham radio, providing both novice and experienced hams with plenty to chew on. Its 432 pages touch on the gamut of amateur radio topics, including how to pass your licensing test, tips on building your station, troubleshooting RF interference, communicating during emergencies, technical fundamentals, and what's new in amateur radio tech (WSJT modes, SDRs, and more). Written in a friendly, welcoming style, Ham Radio for Dummies offers untold hours of great reading and many additional online references where you can dig even deeper into the rabbit hole of ham radio.

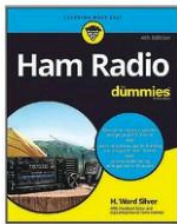

DMV-DUMMIES-4TH Ham Radio for Dummies, 4th Edition **\$34.99**

Antenna Zoning for the Radio Amateur, 3rd Edition

Originally published in 2001 and updated in 2011, the revised third edition of the paperback Antenna Zoning Book for the Radio Amateur by attorney Fred Hopengarten, K1VR, provides you and your representation with 276 pages of invaluable guidance that lets you approach the often intimidating antenna construction permit process with greater confidence. Chapters include Principles that Will Help You Win, Preparing the Permit Application, Possible Objections, Public Hearings—Your Big Moment in the Spotlight, Lawsuits, Appeals, and more. This comprehensive edition has updated details on situations involving HOAs, including a draft of a compromise statute designed to appease all parties.

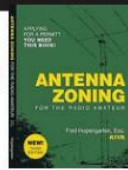

KVR-ZONING-3RD Antenna Zoning for the Radio Amateur, 3rd Edition **\$49.95**

K3MT Technical Books DVDs

K3MT Books

For those who want to dig deeper into the finer points of topics such as NVIS communication, theories behind simple antenna structures, the Smith Chart, and a range of HF antenna concerns, DX Engineering now carries books from Jokalym Press authored by longtime Ham Michael Toia, K3MT. His practical guide, "HF Antenna Topics," shows how Hams have made their own antennas, covering everything from the half-wave dipole to the ground inverted vee and simple Beverages. "You - Coax - and Smith" contains instructions on how to draw a Smith Chart, what it means, and how to use it. "A Guide to the NanoVNA" includes many examples of how to benefit from use of the device, along with 52 photos and screenshots. Enter "K3MT" at DXEngineering.com for more details.

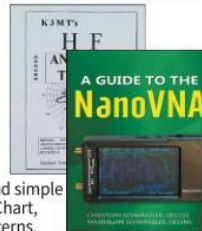

KMT-ANT-TOPICS K3MT's HF Antenna Topics, 2nd Edition..... **\$14.00**
 KMT-NEAR-VERT K3MT's Near Vertical Incidence Skywave Communication, 3rd Edition..... **\$20.00**
 KMT-RADIO-ANT K3MT's Radio Antennas, 2nd Edition..... **\$14.00**
 KMT-SMITH K3MT's You - Coax - and Smith; **\$14.00**
 KMT-NANOVNA K3MT's A Guide to the NanoVNA; **\$16.50**

Ham Radio DX: A Complete Guide

Award-winning DX enthusiast Lucas L. Ford, W6AER, imparts nearly 300 pages of real-world advice and "been there, done that" wisdom covering everything from building your DX station to busting through pileups, choosing an antenna to proper DXing etiquette. There are separate chapters on DXing in CW, Phone, and Digital; FT8 operating; dealing with RFI; use of ferrites, low-band antennas, baluns, and grounding; when and where to work DX; and much more. The book, put out by Vitamin DX Publishing, includes more than 100 photos and illustrations. Ham Radio DX makes a comprehensive addition to your ham radio library whether you're a novice or experienced DXer.

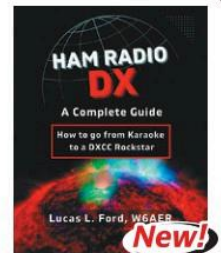

VDX-DX-GUIDE Ham Radio DX: A Complete Guide..... **\$24.99**



Q-View QSL Card Holders

Knee-deep in QSL cards? Art Sci has the perfect solution to protect, organize and display those hard-earned contacts. You can hang them on your wall or fold the holders neatly for storage.



Each package includes a pair of holders that can fit 20 cards a piece, for a total of 40 cards—rescued off of your bench, nightstand, desk and kitchen table. Select from a standard U.S. postcard size (3.5" x 3.5") or the larger international card size (4" x 6").

SIA-QSL-VIEW Q-View QSL Card Holder, U.S. **\$19.95**
 SIA-QSL-VIEWINTL Q-View QSL Card Holder, International..... **\$19.95**

Nifty!



Reference and Operating Guides

Stay up-to-date with the latest modes, band plans, frequency allocations and more. These Nifty guides are indispensable resources for your shack, EMCOMM trailer or club library. DX Engineering also has over 100 of Nifty Reference Guides and Quick Reference Cards, covering a wide range of Amateur Radio equipment. Visit DXEngineering.com to see them all.

Part Number	Description	Price
NIF-EZ-D-STAR	E-Z Guide to D-STAR Operation	\$18.95
NIF-EZ-ECHOLINK	E-Z Guide to EchoLink Operation	\$18.95
NIF-EZ-PSK31	E-Z Guide to PSK31 Operation	\$14.95
NIF-MM-BANDPLAN	HF/VHF/UHF Bands Operating Guide	\$13.95
NIF-MM-DXFIELD	DX Field Reference	\$21.95
NIF-MM-RADIOMG	Radio Monitoring Guide	\$21.95

Champion Radio Books

Champion Radio is regarded as an authority on the subject of antennas and towers, and has published three in-depth books on those subjects.



HF Tribander Performance Test Methods and Results
 Ward Silver N0AX and Steve Morris K7LXC rigorously test ten popular tri-band Yagi antennas (including the DX Engineering Skyhawk™). This updated edition outlines the test protocol, conditions and results.

HF Vertical Performance Test Methods and Results
 Ward Silver N0AX and Steve Morris K7LXC complement their acclaimed HF Tribander book, auditioning several verticals from Butternut® Antennas, MFJ, Diamond and more. The test results are well chronicled.

Up the Tower, The Complete Guide to Tower Construction
 Steve Morris K7LXC has built a lot of towers, and he's put everything he's learned along the way into this book. It covers building codes, proper guying, safety, respecting your neighbors and more.

CRP-TRIBANDBOOK HF Tribander Performance, 2nd Edition **\$20.99**
 CRP-VERTBOOK HF Vertical Performance **\$20.99**
 CRP-TOWERBOOK Up the Tower **\$35.99**

ARES® Apparel

Whether it's just a drill or an actual EMCOMM deployment, outfit your team with official ARRL ARES gear. Dressed in bright neon, you'll remain visible to other emergency workers and to the community. Lightweight and made from breathable mesh, ARRL ARES Deployment Vests feature large front and back reflector panels. The light neon green vests are imprinted with the words "AMATEUR RADIO EMERGENCY COMMUNICATIONS" on the back and display the ARES logo on the left front. Made from cotton, the ARRL ARES Deployment Hat is one size fits most adults and features a large ARES logo. The ARES hat and vests are ANSI/ISEA 107-2004 Class 2 compliant—a criteria for apparel worn by police officers, firefighters, emergency medical services and other public safety personnel.



ARR-0099 ARES Deployment Hat..... **\$14.95**
ARES Deployment Vest
 ARR-0128-S-M Small/Medium **\$20.00**
 ARR-0128-L-XL Large/X-Large **\$20.00**
 ARR-0128-2X-3X 2X-/3X-Large **\$20.00**
 ARR-0128-4X-5X 4X-/5X-Large **\$20.00**

Graph Paper Pads

A great choice for antenna design, mapping out your antenna farm or homebrew brainstorming, these graph paper pads are made of high-quality paper and are bonded with clear, flexible adhesive across the top. The DX Engineering logo is in full color in the upper left corner of the bright-white paper (8" x 11", 50 pages). Large graph squares are just under 1" on a side. There are 10 on the long side of the page and 8 squares across. They are divided into 10 x 10 graphing subdivisions, providing 100 tiny boxes in each large square.



DXE-GRAPHPPAPER Graph Paper Pad **\$13.99**

Pocket Pad

With no batteries to charge and no software to update, our new Pocket Pad is a handy way to record notes and ideas. Better yet—it's compatible with both pen AND pencil. The Pocket Pad is the perfect size for a shirt pocket and has 80 lined notebook pages.



DXE-POCKET-PAD Pocket Pad..... **\$7.99**

We stock many more items than we can show. See them all at DXEngineering.com!

PicoAPRS and VHF Transceiver with GPS Receiver

Version 4 of the matchbox-size (1.3" x 2.6" x 1") PicoAPRS Transceiver with GPS Receiver comes with all the features/applications of Version 3 (APRS tracker, receiver for APRS data, GPS tracker) but adds a VHF 2-meter handheld transceiver with PTT button, microphone, speaker, stored memories, color display and much more—all without significantly increasing its size. It also comes with a larger 240 x 240 color pixel display to show incoming APRS packet data; easier-to-use joystick-style front buttons; KISS data protocol for packet radio via side-mounted USB-C socket, Bluetooth, or Wi-Fi, making it easy to set up an APRS IGate; and WLAN interface that simplifies software maintenance. Updates can now be installed with a built-in web server. The transceiver can be used not only as an APRS tracker and receiver for APRS data but also as a TNC for the computer. The device comes almost fully preconfigured. Simply enter and save your callsign and you're ready to go. With five simple keys, the menu is easily controlled and all settings are accessible, even without a computer. Transmit power is approximately 1W and can be switched down to 0.5W. Position data is transmitted as compressed MIC-E APRS messages to keep transmit duration as short as possible. The transmitter features a 7-pole harmonic filter to suppress unwanted spurious emissions. The built-in 850mAh Li-Ion battery allows operation up to 10 hours depending on configuration. Charging cable and antenna not included. Device takes any antenna with SMA connection. **For more information, enter "PicoAPRS" at DXEngineering.com.**



WMO-PICOAPRS-VHF PicoAPRS and VHF Transceiver \$399.99

PicoAPRS-Lite APRS Transceiver Module

From the innovators at WiMo comes a remarkably powerful and versatile APRS module that can slide into your pocket or easily install out-of-sight in your vehicle, yet is ideal for monitoring world balloon trips. The little brother of the popular PicoAPRS, the PicoAPRS-Lite may weigh only 7.2 grams (without antenna jack, case or power source), but don't let that fool you. It's built for reliably tracking balloon flights with APRS payload (Pico balloons and stratosphere balloons) as well as for many other APRS purposes. Special functions of the PicoAPRS-Lite include:

- Automatic or manual frequency tuning on request (e.g., automatic for worldwide balloon flights)
- Temperature and air pressure sensor
- It can be powered by a small solar cell with buffer capacitor, or single-use or rechargeable batteries
- 3.2 - 5 voltage range
- Even when using batteries, the energy-saving mode will be used between beacon transmissions to extend battery life
- Micro USB port for settings configuration
- Integrated GPS module with balloon mode up to 80km height—perfect for stratosphere balloons
- Transmission power configurable between 0.5 and 1W
- 7-pole lowpass filter to eliminate spurious emissions
- Firmware updates via USB



For more details, enter "PicoAPRS" at DXEngineering.com.
WMO-PICOAPRSLITE APRS Transceiver Module..... \$165.99

Weather Alert Multi-Powered Digital Tuning Radio



The MMR-99 delivers excellent performance and peace of mind in a rugged package. This emergency radio covering AM/FM-RDS and seven NOAA weather channels can be charged by hand-cranking, DC-In power by USB Type-C, or by included solar panel. The radio also serves as a portable battery to charge smaller devices and can be used as a flashlight with 15 different lighting patterns for emergencies or other situations. It runs on a rechargeable 18650 Li-Ion 3.7V/2600mAh battery and comes with weather alert functionality, memory bank with up to 40 station presets for AM/FM radio, Auto Tuning System (ATS), adjustable bandwidth, Bluetooth, IPX55 rating against dust and water, PP reinforcements on each corner to resist damage from drops, and more.



SGN-MMR-99 Digital Tuning Emergency Radio \$149.99

SANGEAN CL-100 Weather Alert Radio

Keep an ear on the NOAA weather bands with this high-quality desktop radio. It features an Emergency Alert to automatically turn on and warn you of impending weather advisories. The radio is programmable for one-button tuning and has an AM/FM tuner as well. The large LCD screen displays weather alerts and RBDS information.



It's a great bedside radio too, with an alarm clock, snooze button and dimmable display. An AUX jack lets you plug in an external audio device.
SGN-CL-100 Weather Alert Radio \$139.99



LST-328-96087INT



LST-581120

Wireless Combo Weather Station

It's like having a personal meteorologist at your disposal (without all the chatty on-air banter)! The La Crosse S81120 Wireless Weather Station delivers live weather data monitoring, including outdoor temperature, barometric pressure, relative humidity, dew point, "feel like" temperature, wind speed, and wind direction. It lets you easily toggle between indoor/outdoor readings and provides temperature/humidity/wind speed alerts, wind speed history, four language settings (English, French, German, and Spanish), 3.77" x 7.01" x 1.14" color LCD, 12/24 hour time setting, your choice of five backlighting settings for customized viewing, and HI/LO records with time/date stamp. Can be wall-mounted or freestanding. Sensors and mounting bracket included.

LST-581120 Wireless Combo Weather Station ... \$121.99

More Wireless Weather Stations from La Crosse

DX Engineering carries a nice selection of La Crosse Weather Stations, including the 328-96087INT Professional Wireless Weather Station, which includes a rain gauge and rain history along with many benefits of the S81120; the V22-WRTH Complete Personal Remote Monitoring Weather Station, which includes weather forecasting, customized alerts, and the ability to monitor your station anywhere via the La Crosse View App; and the V41-PRO-INT and V42 Wireless Professional Weather Stations, which have sensors for tracking wind speed, wind direction, rainfall, temperature, and humidity. The dynamic high-definition color display shows indoor and outdoor data points plus daily/hourly AccuWeather forecast predictions. Can also be combined with View App for further functionality.

- LST-328-96087INT Professional Wireless Weather Station \$167.99
- LST-S82967 Personal Weather Station \$61.95
- LST-V41-PRO-INT Wireless Professional Weather Station, TH2i Sensor \$199.99
- LST-V42-PRO-INT Wireless Professional Weather Station, TH5i Sensor \$199.99
- LST-V22-WRTH Complete Personal Remote Monitoring Weather Station ... \$199.99



LST-V41-PRO-INT

Wireless Weather Station

Get real-time weather data right from your own backyard at an affordable price! This versatile and powerful station lets you monitor barometric pressure, as well as indoor and outdoor temperature and humidity; set customizable temperature alerts; view pressure trends; and keep track of moon phases. No wires or cables required. Dynamic color-forecast icons change based on the weather conditions. The console also displays atomic time and date.



LST-308-1425B Wireless Weather Station \$76.99

SANGEAN

ATS-909X2 World-Band Portable Radio

Sangean's ATS-909X2 World-Band Portable Radio offers significant improvements in functionality while refining the excellent features of the previous ATS-909X model. It features a larger LCD screen, Air Band, a separate headphone amplifier, SSB tuning steps of 10 Hz or 20 Hz, and so much more! The newly designed smart battery system allows the radio to detect faulty batteries and locate its position in the battery compartment when plugged in for charging under standby mode.



SGN-ATS-909X2 World-Band Portable Radio \$458.99

SANGEAN

DT-200X Pocket Radio

You don't accept compromises in your Ham gear, and you shouldn't accept them in your broadcast radios either. Sangean's Pocket Radio gives you FM/AM broadcast bands with 19 presets and a built-in speaker and clock. The auto turn-off feature will conserve its two AA batteries (not included) and the removable belt clip means this radio doesn't necessarily have to live in your pocket.



SGN-DT-200X Pocket Radio \$69.99

Wireless Vantage Pro2 Plus Weather Station

Providing accurate weather monitoring with real-time data updates every 2.5 seconds, the Vantage Pro2 Plus includes a WeatherLink console with vibrant, HD color touchscreen. It features a transmission range of up to 1,000 feet from the sensor suite to the console; sensors for outside temperatures and humidity in passive radiation field, wind speed and direction, rainfall, and UV and solar radiation. The solar-powered sensor suite comes with a battery backup; WeatherLink console is AC-powered with battery backup. The console allows you to navigate and analyze hyper-local weather data or view the latest conditions from anywhere in the room. Set alarms to get notified when conditions change, such as when temperatures begin approaching a critical point for outdoor work or when wind speeds reach a certain level. Compatible with many smart-home systems. Mounting pole not included. The upgraded DVI-6263 model includes a 24-hour fan-aspirated radiation shield for maximum accuracy.



DVI-6262	Wireless Vantage Pro2 Plus Weather Station.....	\$1,575.00
DVI-6263	Wireless Vantage Pro2 w/Fan-Aspirated Radiation Shield.....	\$1,850.00
DVI-7716A	Mounting Tripod for Vantage Vue/Vantage Pro2.....	\$180.00

Davis Instruments Vantage Vue and Vantage Pro2 Wireless Weather Stations

The Vantage Vue Weather Station from Davis Instruments provides real-time, hyper-local weather information—a valuable, self-contained tool for hams, homeowners, farmers, gardeners, weather enthusiasts, and anyone looking for reliable microclimate data. The Vantage Vue includes the solar-powered, ruggedly-housed sensor suite with battery backup (inside and outside temperature and humidity, barometric pressure, wind speed and direction, rainfall, dew point, windchill, and more) and WeatherLink console in a package that delivers dependable weather monitoring and data updates every 2.5 seconds. The station is easy to install and boasts an industry-leading transmission range of up to 1,000 feet from the sensor suite to the WeatherLink console. Vibrant HD color touchscreen console provides simple navigation, access to all sensor data both offline and logged into WeatherLink.com, alarm-setting capability, historical data storage and analysis, and more. The Vantage Pro2 model provides research-grade, professional-quality real-time data with passive radiation field sensor, wind speed measurements up to 200 MPH, and many of the benefits you'll find with the Vantage Vue model. Upgraded model (DVI-6253) includes 24-hour fan-aspirated radiation shield for maximum accuracy. **Enter "DVI Weather Station" at DXEngineering.com for more details.**



DVI-6242	Vantage Vue Weather Station.....	\$695.00
DVI-6252	Vantage Pro2 Wireless Weather Station.....	\$995.00
DVI-6253	Vantage Pro2 Wireless Station w/ Fan-Aspirated Radiation Shield.....	\$1,275.00
DVI-7716A	Mounting Tripod for Vantage Vue/Vantage Pro 2.....	\$180.00

Davis Instruments Weather Forecasting Quick Reference Cards

This card shows you how to use the information from your fancy weather station. It tells you how to interpret barometric pressure, wind direction, cloud types and more. Get years of meteorology lessons on a single card—perfect for weather-watchers, boaters and Hams.



DVI-131	Weather Forecasting Quick Reference Cards, Set of Two.....	\$14.99
---------	--	----------------

Tornado Alert

Protect your family and ham radio station with Tornado Alert, the world's first personal tornado detector. The device constantly monitors the skies in real-time for electrical activity, the scientifically proven cause of tornado formation. Tornado Alert will tell you when a tornado, lightning, or severe weather is detected within a 30-mile radius of your location, providing up to 30 minutes warning to get to safety, day or night. The backlit display shows raised warning levels as the emergency weather approaches. The device includes a powerful built-in antenna, 90 dB siren, live proximity readings that let you know how close the threat is to your location, strobe light, and simple two-button setup. By installing a backup battery, the Tornado Alert will keep you protected even with the loss of A/C power (battery not included).



TDO-TORNADOALERT	Tornado Detector.....	\$155.95
------------------	-----------------------	-----------------



Digital Atlas 4K

Geochron has made it easier than ever for operators to enjoy all the functionality and Ham-friendly features of its mechanical world clock—at a fraction of the cost.

The Digital Atlas 4K gives viewers magnificent displays of the Earth with sunrise-sunset rendered in real time through a small computer that plugs directly into a 4K TV (not provided) via HDMI.

The size of the display is only limited by the size of your TV. The Ham Radio mapset comes packed with features made for amateur radio operators, including display of the "Grey Line" (the band around the Earth separating daylight from darkness) in real time—a huge benefit for optimizing long-distance communication. It also includes DX and International Prefixes; Country Names and Borders; Equatorial, Latitude and Longitude, and Tropic Points of Reference; Major Topographical Features; the Analemma, Showing the Sun's Position at Relative Noon; and Month, Day, and Hour of Every Time Zone on Earth, Including Zulu Time.

This latest version (GEO-400-1000B) comes with an array of new features:

- More powerful hardware platform with 4x faster refresh rates
 - More capable Wi-Fi functionality
 - Quad-core Intel processor
 - Faster menu operation
- Other features include:**
- Continuously updating* (with internet*) Global Satellite Weather Overlays showing precipitation, wind speed, barometric pressure, temperature, and cloud cover
 - Static overlays that show Earth at night, major shipping routes, major flight routes, carbon monoxide pollution, human population, and simultaneous UTC with local time readout
 - Live location of the International Space Station and over 300 satellites updated every second*
 - 16 locations pins with custom text names and local time that you can place anywhere on the map

Along with the mini-computer, you receive a three-foot cord power supply; one-foot HDMI cable, male to female; remote control and AAA batteries; one-year warranty; and new updates as available with user-provided Internet service.

GEO-400-1000B	Digital Atlas 4K.....	\$479.00
---------------	-----------------------	-----------------

DX Engineering Folding Chair

Made from water-resistant poly-canvas, this durable chair is designed for heavy-duty use. This folding chair supports 350 lbs. and is big enough to be comfortable! It also has an HT or beverage holder in one arm—Brown 807s anyone? It's perfect for extra seating on the deck or in the yard. When you're looking for a new camp-type folding chair, remember this rugged, large DX Engineering Folding Chair.

DXE-FC-1BK	Folding Chair with Bag.....	\$29.99
------------	-----------------------------	----------------



DX Engineering Umbrellas

Open the DX Engineering Logo Umbrella when you need to keep the sun from baking your equipment (or your neck) during Field Day. Its 36" diameter is made to cover you, your gear or the XYL. It collapses to a compact size and includes a carrying pouch.

DXE-UMBRELLA.....	\$9.99
-------------------	---------------

Golf Umbrella

For maximum protection from whatever Mother Nature dishes out on your outdoor operating adventures, go with the 54" diameter DX Engineering Logo Golf Umbrella. It's collapsible for easy transport, comes with a handy carrying sleeve, and lets you tell the neighborhood, your golfing buddies, or ham friends where you get your amateur radio gear.

DXE-GOLFUMBRELLA.....	\$17.99
-----------------------	----------------



DX Engineering carries equipment from more than 160 top manufacturers!



Shortwave Radios and Home Emergency Products

DX Engineering is pleased to now carry shortwave radios and home emergency items from Eton Corporation—an American company that has gained a strong worldwide reputation for its innovative and trusted products since 1986.

Elite Series Shortwave Radios

Eton's finely crafted portable radios come in a range of configurations, all loaded with state-of-the-art features. Choose from the top-of-the-line Elite Satellit model, which combines a stylish design with AM, FM, SW, LW, and Air coverage. Advanced features include digital HD quality, 1,700 memory channels, and high dynamic range for detection of weak signals in the presence of strong signals. The Elite 750, which covers AM-MW, FM, SW, LW, SSB, and Air frequencies, includes a 360-degree rotating AM antenna for pulling in weak signals, the ability to program up to 100 channels for each band, 1,000 station memories, and MP3 player connectivity. The compact and powerful Elite Executive model, which comes in an attractive leather case, receives AM(MW), FM with Radio Data System (RDS), LW, SW, SSB, and VHF Aircraft band frequencies, plus includes a PLL tuner to ensure AM signals are strong and clear. The Bluetooth-ready Elite Field radio lets you enjoy AM (MW), FM with RDS, and SW frequencies along with streamed music and podcasts. The Elite Traveler (AM-MW, FM, LW, and SW) features 500 memory stations and sleep timer/alarm clock, making it a great companion on the road. Finally, the Elite Mini AM/FM shortwave model comes in a custom leather pouch and packs a powerful punch thanks to its internal AM antenna and telescoping FM/SW antenna for local and worldwide listening. Enter "Eton Elite" at DXEngineering.com for more details.



EON-NELITESATELL	Elite Satellit HD AM/FM/SW/LW/Air Portable Radio.....	\$499.99
EON-NELITEEXECUT	Elite Executive AM/FM/LW/SW Portable Radio.....	\$199.99
EON-NELITEEXCHD	Elite Executive AM/FM/LW/SW w/Color LCD.....	\$299.99
EON-NELITEFIELD	Elite Field AM/FM/SW Bluetooth Portable Radio.....	\$169.99
EON-NFIELD-BAG	Synthetic Leather Satchel for Elite Field Radio.....	\$29.99
EON-NELITETRAVEL	Elite Travel AM/FM/LW/SW Portable Radio.....	\$79.99
EON-NELITEMINI	Elite Mini AM/FM/SW Portable Radio.....	\$39.99

Emergency/Weather Radios

Don't get caught unprepared! The reliable and versatile lineup of Eton emergency/weather radios includes the Sidekick, featuring solar-powered charging, Bluetooth technology, bright LED flashlight, 2,600 mAh rechargeable Li-Ion battery, and hand crank which produces power for 10-15 minutes of operation after four minutes of cranking. The Scorpion II has a rugged exterior with an aluminum carabiner for extreme outdoor conditions. The ZoneGuard model includes seven built-in NOAA/Environment Canada weather band stations and the ability to enter your county code to receive audible and visual weather alerts. The FRX2 model features a flashlight and 1,000 mAh Li-Ion battery that is rechargeable by built-in solar panel, hand crank, or included mini USB cable. The FRX3+ radio offers the same flexible power options with a more powerful 7V 2,600 mAh battery. Enter "Eton Weather Radio" at DXEngineering.com for more details.



EON-NFRX5SIDEKIC	Sidekick AM/FM/NOAA Portable Weather Radio.....	\$99.99
EON-NSP101WXGR	Scorpion II Multi-Purpose AM/FM/NOAA Radio.....	\$59.99
EON-ARCZG100W	ZoneGuard AM/FM/NOAA Weather Radio.....	\$59.99
EON-ARCRCR100RSNG	FRX2 Compact AM/FM/NOAA Weather Radio.....	\$39.99
EON-ARCRCR3-WXR	FRX3+ AM/FM/NOAA Weather Radio.....	\$59.99
EON-ARCODYSSEY	Odyssey AM/FM/SW/Weather Band Bluetooth Emergency Radio.....	\$79.99

Emergency Lights

The compact Blackout Buddy Swivel Emergency Flashlight is a great way to light up a trail, brighten a tent, or serve as a nightlight. The swivel lets you direct the light where you need it. Plus, when plugged into a 120 VAC outlet, the three-LED Blackout Buddy automatically illuminates when the AC power goes out (lasts up to four hours on a single charge). The Blackout Buddy Color version also serves as a motion-activated nightlight. The Blackout Buddy Connect Color is customizable when connected to the Eton app via Wi-Fi or to Amazon Alexa or Google Home. Choose between 16 million colors and receive notifications when motion is detected or add these devices to your Smart Home routines for more possibilities. When plugged in, the Blackout Buddy Charge automatically turns on its bright LED emergency light if the power goes off or serves as a nightlight when unplugged (provides 30 hours of light thanks to its built-in 2,000 mAh rechargeable lithium battery). Enter "Eton Lights" at DXEngineering.com for more details.

EON-ARCBB201WSNG	Blackout Buddy Swivel Emergency Flashlight/Nightlight.....	\$9.99
EON-ARCBB202CSNG	Blackout Buddy Color Motion-Activated Nightlight/Flashlight.....	\$19.99
EON-ARCBB203USNG	Blackout Buddy Connect Color Customizable Motion-Activated Nightlight/Flashlight.....	\$39.99
EON-ARCBB300WSNG	Blackout Buddy Charge Rotatable Nightlight/Flashlight.....	\$29.99
EON-NCNCTCMBO-AG	Blackout Buddy Nightlight/Flashlight, Carbon Monoxide/Natural Gas Detector.....	\$149.99
EON-ARCPT100W	Road Torque Self-Powered Spotlight/Emergency Beacon.....	\$29.99
EON-ARCRCR100RSNG	Clipray Hand Crank, Clip-On Flashlight/Phone Charger.....	\$9.99



Gel Mouse Pad

Whether checking out articles on OnAllBands.com, making FT8 contacts, or working in the office, you'll appreciate having this soft, gel-filled wrist pad that provides the support you need to prevent fatigue. The 9" x 7.50" x 1" pad features a non-slip rubber base that keeps it firmly planted on the desk for worry-free clicking. The DX Engineering logo is silkscreened in the center of its black jersey polyester cover.

DXE-GEL-MOUSEPAD	DX Engineering Gel Mouse Pad.....	\$24.99
------------------	-----------------------------------	----------------



DX Engineering Sport Bag

An ideal travel companion, this sport bag can hold everything from your spare cables and gear to an extra pair of socks for soggy Field Days. Made from polyester cloth with a PVC coating for moisture resistance. The padded foam bag has several zippered pockets—including one big enough for a pair of shoes. The bag's detachable strap makes it easy to sling over your shoulder.

DXE-SPORTBAG2017	Sport Bag.....	\$49.99
------------------	----------------	----------------

DX Engineering Tote Bag

Let DX Engineering help you carry that weight! This well-made, 100% polyester zippered bag makes a great companion at Hamfests, Field Day, or for a trip to the grocery to pick up strong coffee and munchies for that 48-hour contesting marathon. It boasts ample room for small gear, snacks, convention freebies and whatever else you can't do without. Two mesh side pockets and one large outside front pocket keep your stuff secure, and its reinforced, adjustable straps are perfect for comfortable carrying or hauling on the shoulder.

DXE-TOTE-BK-RD	Tote Bag.....	\$27.99
----------------	---------------	----------------



DX Engineering Giant Tool Bag

What better place to store your DX Engineering tools and whatever else you're taking into the field, or keeping handy in the shack, than with a DX Engineering Giant Tool Bag. The well-built canvas bag with heavy-duty, two-way zipper enclosure has plenty of space for the tools, hardware, and fasteners you need to keep your station well maintained and on the air. The 20" x 11" x 10" water-repellant bag features a reinforced bottom, anti-skid rubber feet, and 27 pockets—21 outside and six inside.

DXE-TOOLBAG	Giant Tool Bag...	\$21.99
-------------	-------------------	----------------

DX Engineering Face Mask

Made with comfortable, stretchy polyester and featuring the DX Engineering logo, this one-size-fits-all, pull-over-the-head neck gaiter face mask can easily be positioned over the mouth and nose.



NOTE: This product, like any cloth covering, cannot guarantee the prevention or possibility of the spread or contraction of any virus or pathogen.

DXE-FACEMASK	DX Engineering Logo Gaiter-Style Face Mask.....	\$6.99
--------------	---	---------------

Check out our YouTube channel for in-depth tech tips and product demos!



Mugs and Tumblers

Staying hydrated or sufficiently caffeinated is important during marathon sessions on the air. You'll find the quality beverage containers you need at DX Engineering, including the new DX Engineering logo 30 oz. vacuum-insulated tumbler made from double-wall stainless steel. Equipped with a leak-resistant, gasket-sealed acrylic lid, this "Kong-sized" vessel (8" tall) is designed to keep drinks hot for two hours and cold for up to 36 hours! Also check out the dishwasher-safe 40 oz. Travel Tumbler with secure lid and DX Engineering logo.

DXE-COFFEEMUG	White Coffee Mug.....	\$9.99
DXE-40OZTRAVELBK	40 oz. Stainless Steel Travel Tumbler with Handle....	\$24.99
DXE-30OZ-TUMBLER	30 oz. Stainless Steel Tumbler	\$31.99
DXE-16OZ-MUG	16 oz. Ceramic Bistro Mug.....	\$19.99
DXE-17OZ-SSMUG	17 oz. Stainless Steel Mug	\$25.99
DXE-26OZBOTTLED	26 oz. Red Water Bottle	\$12.99

DX Engineering Christmas Tree Ornament

Brighten your home, work cubicle or shack with this 3.25" crystal ornament. Made in the USA from shatterproof material and given a shining red finish, it's an accessory that will surely put your ham friends in the holiday spirit and tell everyone where you get your amateur radio gear!

DXE-ORNAMENT-RED	Christmas Tree Ornament	\$9.99
------------------	-------------------------------	---------------



DX Engineering Cinch Bag

This small, lightweight backpack-style book bag will make toting stuff at your next operating event a "cinch." The dark charcoal, 100% cotton bag features a double drawstring with a plastic clasp at the top to keep it "cinched up" and your valuables secure. A zippered outer pouch lets you stash even more items. Two reinforced adjustable straps enable you to use it like a backpack for outdoor adventures or hands-free bargain-hunting at hamfest flea markets. As a finishing touch, the DX Engineering logo is embroidered on the back. A handy accessory for adults or kids.

DXE-CINCHPACK	Canvas Cinch Bag	\$26.99
---------------	------------------------	----------------



"Just One More Radio, I Promise" T-Shirt

Exclusively available from DX Engineering, the "Just One More Radio, I Promise" crew neck cotton T-shirt will speak volumes about your passion for the HT, mobile and base rigs you collect. Of course your ham friends will know it's a promise we cannot keep, so they'll get the joke right away! The stylish and comfortable shirt features a bold graphic on the back and a smaller radio on the front. Available in a variety of men's sizes.

TDE-0559_	Just One More Radio T-Shirt.....	\$19.99
-----------	----------------------------------	----------------



DX Engineering Ball Caps

Arm yourself with the latest in sun blocking, head-covering technology—the DX Engineering Ball Cap. Straight from the Paris runway, this fashionable cap proudly puts on display the full-color DX Engineering logo. It's fully adjustable, for style-conscious amateur operators of all sizes. Then add the Realtree Edge Camo Hat to your ham radio wardrobe! It features a durable 60/40 cotton-poly canvas blend, six-panel camouflage design, pre-curved bill, adjustable closure, and DX Engineering logo. One size fits all adults.

DXE-HAT	Ball Cap.....	\$9.99
DXE-CAMO-HAT	Realtree Edge Camo Hat.....	\$23.99



DX Engineering Knit Caps

Whether shoveling a path out of your shack or making QSOs on Winter Field Day, tell the world you're a Ham for all seasons with these DX Engineering logo knit caps. These 100% acrylic/polyester, machine-washable, one-size-fits-all hats look great and are made to keep your ears toasty warm. A great gift for Amateur Radio fashionistas! Available in cuff beanie style (black) and beanie with pom pom (black/gray).

DXE-KNIT-CAP-BK	Black Cuff-Style Knit Cap.....	\$16.99
DXE-KNIT-CAP-GY	Black/Gray Knit Cap with Pom Pom	\$17.99



DX Engineering Fleece/Polyester Jackets

Round out your DX Engineering-themed wardrobe with this warm and comfy full-zippered fleece/polyester jacket, available in either red or black with embroidered DX Engineering logo sewn right into the jacket's front. Add in two zippered front pockets and you've found yourself the perfect go-to outfit for fall and winter Ham events. Available in men's small to 4X-large sizes.

DXE-TMA-311_	DX Engineering Fleece/Polyester Jackets.....	\$40.99
--------------	--	----------------

DX Engineering Kneeling Mat

If you've ever dreaded cleaning the bathtub, weeding the vegetable garden, or lowering yourself to the floor to untangle some wires under a desk, worry no longer. The DX Engineering Kneeling Mat makes it much easier to finish chores in the yard, the shack, and around the house without putting undue stress on your knees. Made from EVA foam, the 19" L x 11.5" W pad is the perfect solution for making on-the-ground activities a lot more comfortable.

DXE-KNEEL-PAD	Kneeling Pad	\$16.99
---------------	--------------------	----------------



DX Engineering T-Shirts

Ham radio shirts are a great way to meet other operators and make some eyeball QSOs. These 100% cotton shirts come in black or white with a single embroidered DX Engineering logo on the front or with the logo on the front and large on the back, so you can show off your ham pride coming or going. Available in a range of sizes.

White, Single Logo, Embroidered

DXE-TMA-10019	Large.....	\$16.99
DXE-TMA-10020	X-Large	\$16.99
DXE-TMA-10021	2X-Large	\$18.99

Black, Single Logo, Embroidered

DXE-TMA-10016	Large.....	\$16.99
DXE-TMA-10017	X-Large	\$16.99
DXE-TMA-10018	2X-Large	\$18.99

Black, Dual Logos, Silkscreened

DXE-TMA-10061	Small	\$12.99
DXE-TMA-10062	Medium	\$12.99
DXE-TMA-10063	Large.....	\$12.99
DXE-TMA-10064	X-Large	\$12.99
DXE-TMA-10065	2X-Large	\$14.99
DXE-TMA-10066	3X-Large	\$15.99



Long-Sleeve T-Shirt

Perfect for those days when it's not quite right for a short-sleeve shirt but too hot for a sweatshirt, these 100% cotton long-sleeve shirts fit the bill! They feature the DX Engineering logo on the front left chest and large on the back, 1x1 rib knit cuffs, tear-away label, a feel that's soft to the touch, and a comfortable fit. Available in Black, Royal Blue, and Charcoal in men's small to 4X-large.

DXE-TMA-101_	Long-Sleeve T-Shirt... from	\$18.99
--------------	-----------------------------	----------------

Short-Sleeve Pocket T-Shirt

Crafted from premium, ultra-soft cotton that ensures maximum comfort and a great fit, these stylish pocket T-shirts are a great choice for wearing around the house or at your next club meeting. They feature the DX Engineering logo embroidered on the right, strong-seamed shoulder-to-shoulder taping for durability, and tear-away label. Available in Charcoal Heather (60/40 cotton/poly blend) and Deep Red (100% cotton) in men's small to 3X-large.

DXE-TMA-1007_	Short-Sleeve Pocket T-Shirt, Charcoal	from \$24.99
DXE-TMA-1008_	Short-Sleeve Pocket T-Shirt, Deep Red	from \$24.99



For new hams, check out our Getting Started HT, Mobile, and Base Radio Packages!



Rapid Dry™ Mesh Polo

Pocket Polo

Classic Polo

DX Engineering Polo Shirts

When your next club event or Hamfest calls for business casual attire, reach for the classic red, black and white DX Engineering polo shirt. They're made of a lightweight, breathable polyester weave for outdoor and indoor comfort. Available in a variety of men's sizes.

Classic Polo Shirt

DXE-TMA-100_ Classic Polo Shirtfrom **\$33.99**

Rapid Dry™ Mesh Polo Shirts

These stylish and comfortable red shirts featuring an embroidered DX Engineering logo combine a smooth cotton feel with Rapid Dry moisture-wicking mesh cotton/poly material that offers breathable performance for all-day wear. Available in men's and women's styles and sizes.

DXE-TMA-1105_ Rapid Dry™ Mesh Polo Shirt Men's from **\$36.99**

DXE-TMA-1106_ Rapid Dry™ Mesh Polo Shirt Women's from **\$36.99**

Pocket Polo Shirt

Look sharp, professional, and a bit like Johnny Cash in these black, snag-proof polyester polo shirts featuring an embroidered DX Engineering logo and left front pocket.

Pocket Polo Shirts are available in men's small to 4X-large. Enter "pocket polo" at DXEngineering.com for more details.

DXE-TMA-1203_ Pocket Polo Shirtfrom **\$39.99**

DX Engineering Zippered Hooded Sweatshirts

This cotton/poly fleece hoodie, featuring a color-fast embroidered DX Engineering logo, is the kind of apparel you can put on in the morning and wear all day without thinking twice. Heck, go ahead and sleep in it if you'd like—it's that comfortable! Its full zipper closure lets you decide if you want to keep drafts out or let some air in. And the attached hood is great for keeping sun and rain off your head, or for going incognito. Includes front pockets and draw cords. Choose from royal blue, charcoal or black in small to men's 4X-large sizes.

DXE-TMA-211_ DX Engineering Hooded Sweatshirt...from **\$40.99**



DX Engineering Sweatshirts

When the weather's on the chilly side and you've got connector weatherproofing on your to-do list, slip on this sweatshirt and you'll soon be thinking warm thoughts about the hobby you love. Made from comfortable cotton/poly fleece, this high-quality long-sleeve sweatshirt features an embroidered DX Engineering logo that's durable and won't fade in the wash. Choose from navy blue, gray, light gray and green in men's small to 4X-large sizes.

DXE-TMA-111_ Sweatshirtfrom **\$25.99**

DX Engineering Pullover Hooded Sweatshirts

These finely made 50/50 blend cotton/poly fleece hoodies are perfect for chilly days of outdoor antenna repairs or for just tooling around the house thinking warm thoughts about the next major contest. They feature front pouch pocket, 3" rib knit cuffs and hem, tear-away label, and embroidered DX Engineering logo that won't fade in the wash. Available in dark heather gray, heather maroon, and olive drab green, men's sizes small to 4X-large. Enter "Hooded Sweatshirt" at DXEngineering.com.

DXE-TMA-411_ Pullover Hooded Sweatshirt.....from **\$31.99**



DX Engineering Sport-Wick® Stretch 1/4 Zip Long-Sleeve Pullover

Enjoy the style, warmth, and comfort of these polyester/spandex blend long-sleeve pullovers with the DX Engineering logo embroidered on the left chest. They're available in Black, Red, Charcoal, and Royal Blue in men's and women's small to 4X-large. Tall sizes are also available.

DXE-TMA-81_ Women's Stretch 1/4 Zip Long-Sleeve Pullover **\$45.99**
 DXE-TMA-82_ Men's Stretch 1/4 Zip Long-Sleeve Pullover **\$45.99**
 DXE-TMA-83_ Tall Men's Stretch 1/4 Zip Long-Sleeve Pullover **\$47.99**



DX Engineering Logo Women's Apparel

DX Engineering now carries a full lineup of comfortable, quality-made clothing with the DX Engineering logo in women's sizes from small to 4X-large. Get yours now for Field Day!

DXE-TMA-711_ V-Neck Short-Sleeve T-Shirts.....from **\$24.99**

Featuring tri-blend softness, these stylish and nice-fitting T-shirts come in Heather Gray or True Royal Heather.

DXE-TMA-721_ Lightweight Long-Sleeve Hoodies.....from **\$25.99**

Conquer your next POTA or SOTA adventure in tri-blended comfort. Choose from Black Frost or Fuchsia Frost colors.

DXE-TMA-731_ 3/4-Sleeve Raglan-Style T-Shirts.....from **\$23.99**

These comfortable tri-blend T-shirts feature a Red Frost/Gray Frost color scheme.

DX Engineering Youth T-Shirts and Baby Rompers

For young ones prone to loudly transmit "CQ-Bottle" in the middle of the night, these DX Engineering Baby Rompers make the perfect attire. They display an embroidered DX Engineering logo on comfortable ring-spun cotton/poly fine jersey material. The gray rompers with red sleeves and trim come in sizes for 6- or 12-month-olds and feature flatlock stitch ribbed collar and raglan armholes, double-needle sleeves, double-needle ribbed binding on leg openings, and a three-snap closure. When they outgrow it, just pack it away in a cedar chest and present it to them when they've earned their DXCC! For growing hams, the classic 100% cotton black DX Engineering T-shirt is now available in youth sizes small to X-large.

DXE-TMA-51111 Black T-Shirt, Youth Size, Small..... **\$12.99**
 DXE-TMA-51112 Black T-Shirt, Youth Size, Medium..... **\$12.99**
 DXE-TMA-51113 Black T-Shirt, Youth Size, Large **\$12.99**
 DXE-TMA-51114 Black T-Shirt, Youth Size, X-Large **\$12.99**
 DXE-TMA-61111 Baby Romper, 6 Months **\$19.99**
 DXE-TMA-61112 Baby Romper, 12 Months..... **\$19.99**



Most in-stock parts ship throughout the contiguous US in just 1-2 days!

Redcap Short-Sleeve Work Shirt

Here's the perfect attire for when there's work to be done around the shack. These Redcap work shirts are made from a high-quality 4.25 oz. 65/35 poly-cotton blend, making them comfortable and rugged enough to stand up to the toughest jobs. The shirt features the latest stay-clean technology so they look sharp throughout the day, superior color retention, two button-through front pockets, open collar with sewn-in stays, and embroidered DX Engineering logo. Available in Black, Charcoal, and Navy in men's small to 4X-large.



New!

DXE-TMA-131_ Redcap Short-Sleeve Work Shirt from **\$34.99**

Keys and Accessories

Equip your amateur radio station with high-performance Bencher keys and accessories. All Bencher products are fabricated and assembled in the USA by skilled professionals, using the finest materials for superior performance and durability.



BENCHER, INC.

Keys

BNR-RJ-1	Hand Key, Black Base	\$159.95
BNR-RJ-2	Hand Key, Chrome Base	\$189.95
BNR-BY-1	Iambic Paddle, Black Base/Chrome Parts	\$179.95
BNR-BY-2	Iambic Paddle, Chrome Base/Chrome Parts	\$219.95
BNR-ST-1	Single Lever Paddle, Black Base/Chrome Parts	\$149.95

Accessories

BNR-EZ-1	4" Hook-up Cable, 1/8" and 1/4" Plugs	\$12.95
VIB-DC-BY	Cover for BY-Series Paddles	\$39.95



XT-4-MK2 Memory Keyer

The perfect keyer for Field Day, vacations, EMCOMM, or just about any portable operation, the compact and lightweight XT-4-MK2 is fully iambic with self-completing characters. This battery-powered keyer features a CW speed range of 8-45 WPM, and each of the four memories can hold approximately 240 Morse characters. The non-volatile memory locations save your programmed information even when the power is removed. Programming your CQ, call sign, contest exchanges, name, QTH, and other information is easily accomplished by pressing the record and message buttons. A paddle reverse function lets you reverse the dit and dah keys without rewiring the cable. Designed to work with modern solid-state rigs with positive keying.



New!

UMS-XT-4-MK2	Memory Keyer	\$89.95
UMS-KC-4	Cable Set, XT-4-MK2/VK-64 Keyers, 1/4" Plug, Keyer to Rig	\$14.95
UMS-KC-8	Cable Set, XT-4-MK2/VK-64 Keyers, 1/8" Plug, Keyer to Rig	\$14.95

Keyer Cables

Use these to connect your MFJ Keyer to your radio. The cables have an RCA phono plug on one end and a 3.5mm (with included 1/4" adapter) plug on the other.

MFJ-5164	Keyer Cable, 6'	\$21.95
MFJ-5166	Keyer Cable, 3'	\$26.95

MFJ

PaddlePads

A Morse code operator's best friend, DX Engineering PaddlePads are the perfect way to keep your straight key, bug, or paddle from traveling when you're working the world. These soft, pliable, and washable 1/16"-thick "grippy-sticky" pads come in two sizes (small, 5.4" x 3.4" and XL, 8.3" x 6.2") to keep everything from tiny, lightweight paddles to larger, heavier devices from sliding around in the heat of a CW contest. Amazingly, the pads feel sticky to the touch but use no adhesives that leave sticky or oily residue. Besides ham radio applications, they're also handy for keeping just about anything on a relatively flat surface from slip sliding away.



DXE-PADLEPAD-SS	Small 5.4" x 3.4" PaddlePad	\$8.99
DXE-PADLEPAD-XL	XL 8.3" x 6.2" PaddlePad	\$11.99

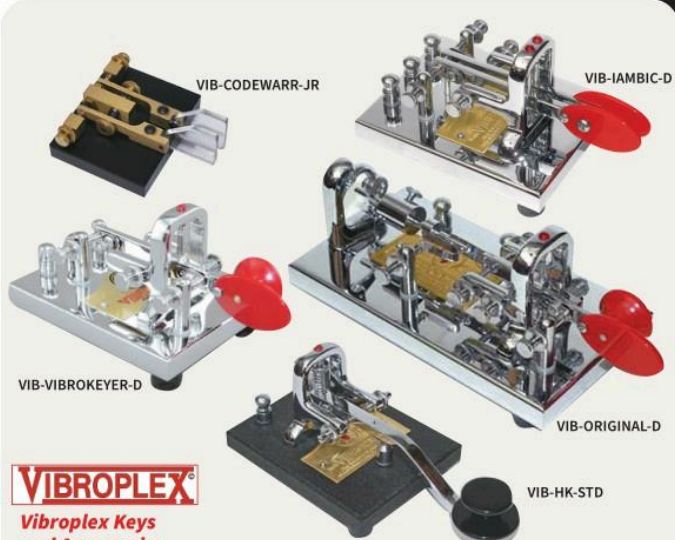

VIBROPLEX®

Vibroplex Keys and Accessories

Vibroplex has been a leading manufacturer of quality CW keys and amateur radio accessories for over 100 years. From the Original Bug (in continuous production since 1905) to the always-reliable straight key, we have a wide selection of Vibroplex models to choose from. Over 300,000 Vibroplex keys are in circulation today because of their durability and unwavering performance.

Keys

VIB-CODEWARR-JR	Black Code Warrior Jr.	\$124.95
VIB-IAMBIC-S	Iambic Paddle Standard	\$189.95
VIB-IAMBIC-D	Iambic Paddle Deluxe	\$229.95
VIB-IAMBIC-G	Iambic Paddle Gold	\$322.95
VIB-VIBROKEYER-S	Vibrokeyer Single Paddle Standard	\$189.95
VIB-VIBROKEYER-D	Vibrokeyer Single Paddle Deluxe	\$229.95
VIB-VIBROKEYER-G	Vibrokeyer Single Paddle Gold	\$322.95
VIB-ORIGINAL-S	Original Bug Standard	\$249.95
VIB-ORIGINAL-D	Original Bug Deluxe	\$289.95
VIB-HK-STD	Straight Key Standard	\$179.95
VIB-HK-DELUXE	Straight Key Deluxe Chrome	\$219.95

Accessories

VIB-DC-VIBRO	Dust Cover for HK/Iambic/Vibrokeyer	\$39.95
VIB-DC-ORIG	Dust Cover for Original Bug	\$42.95
VIB-DC-BY	Dust Cover for Bencher BY Series	\$39.95
VIB-405-CCS	Contact Cleaner Abrasive Strip	\$9.99
VIB-CP-2	2-Conductor Cable 1/4" Plug (Bug or Hand Key)	\$9.95
VIB-CP-3	3-Conductor Cable 1/4" Plug (Paddles)	\$179.95
VIB-CP-3-3-5MM	3-Conductor Cable 3.5mm Plug (Paddles)	\$9.95



VIB-DC-VIBRO



VIB-CP-2



VIB-CPO



VIB-CPO-PLUS

Code Practice Oscillator Kits

Comprised of a small PCB and speaker, these kits let you practice code using your own key or bug for a real tactile CW experience. The units generate a pleasant 700 Hz tone and are powered by a single 9V battery. They're the perfect choice for clubs that hold regular CW classes.

VIB-CPO	Practice Oscillator Kit	\$24.95
VIB-CPO-PLUS	Practice Oscillator Kit, with Key Hookup Cable	\$29.95



Join our crew on Facebook for news and exclusive deals!

HA8KF

MAGNETIC PADDLE



HA8KF Magnetic Paddles

Equip your shack with a European-made HA8KF iambic dual-lever magnetic tension paddle and feel the comfort and ease a finely crafted instrument can make for your CW sessions. Offered exclusively in North America by DX Engineering, these handmade paddles come with an extra-heavy steel base and loosely threaded thumbscrews that allow for easy tension adjustments on the fly. They feature a solid brass polished hub and either red or blue finger pieces. Each plug-and-play model comes pre-wired with a 1/4" phone plug (6.35mm male TRS). Large square, large round or small round styles are available.

Red Paddle

HKF-KEY-A	Large Square Base	\$279.99
HKF-KEY-BR	Large Round Base	\$279.99
HKF-KEY-SR	Small Round Base	\$279.99

Blue Paddle

HKF-KEY-LA	Large Square Base	\$279.99
HKF-KEY-LR	Large Round Base	\$279.99
HKF-KEY-SL	Small Round Base	\$279.99

Single Paddle

HKF-SINGLE-RR	Single, Red Paddle, Black Base	\$279.99
HKF-SINGLE-SS	Single, Gray Paddle, Black Base	\$279.99
HKF-SINGLE-RR-SS	Single, Red Paddle, Gray Base	\$279.99

SOTA Paddle

HKF-KEY-SOTA	Dual, Red Paddle, Square Aluminum Base	\$279.99
--------------	--	----------

Tourist Paddle

HKF-TOURIST-RR	Dual, Red Paddle, Square Black Base	\$199.99
----------------	---	----------

MFJ

MFJ-495 Millennium CW Memory Keyer

With the MFJ-495, you get a feature-laden keyer with dual microprocessors and nonvolatile EEPROM chip for excellent reliability. You can key in CW with your paddle, keyboard or through a computer serial port. MFJ-495's battery backed-up memory allows you to store messages and settings. This user-friendly keyer also features an internal speaker and simple interface, which makes it easy to set up and start sending CW.

MFJ-495 Millennium CW Memory Keyer \$249.95

MFJ-407E Curtis Deluxe Electronic Keyer

Using cutting-edge microprocessor control, the MFJ-407E gives you iambic key operation and dot-and-dash memory to help you send perfect code. You can adjust code speed, weight and side tone frequency, plus this keyer is compatible with your key, and single or dual paddle.

MFJ-407E Curtis Deluxe Electronic Keyer \$129.95



CHELEGANCE

JNCRadio

Double Paddle Key and Straight Key

Perfect for portable ops or in the shack, the lightweight (1.5 lbs.) and compact JNCRadio K-1 Golden Brass Iambic Double Paddle Key comes with silver-plated contacts and black plastic finger pieces attached to brass arms that pivot on stainless steel aircraft bearings with brass thumb-screw spring tension and contact spacing adjustments. Three all-brass thumb-screw binding posts provide the connections for a user-supplied cable. The LM-V2 Straight Hand Key features chrome finish, steel base (2.5 lbs.), and separate adjustments for height, contact spacing, and return spring tension.

NCE-CH0030005	Brass Iambic Double Paddle Key	\$179.99
NCE-CH0030014	LM-V2 Straight Hand Key	\$159.99



NCE-CH0030005



HIM-MK-705



HIM-HK-808

HI-MOUND

HI-MOUND ELECTRO CO., LTD

Hi-Mound Keys and Paddles

Another winning addition to our lineup of CW key manufacturers, Hi-Mound offers straight keys that accommodate both American (low profile) and British (high profile) sending styles. Founded in Japan in 1947, Hi-Mound makes keys that are ideal for both new operators and longtime CW specialists. Also available are economy, standard and deluxe iambic paddles. Check out models that come with a solid marble base for a distinctive look in your shack. For more details, enter "Hi-Mound" at DXEngineering.com.

HIM-HK-705	Economy Straight Key, Low Profile, No Base	\$49.95
HIM-HK-706	Clear Cover Straight Key, Low Profile, Plastic Base	\$99.95
HIM-HK-707	Black Cover Straight Key, Low Profile, Plastic Base	\$99.95
HIM-HK-708	No Cover Straight Key, Low Profile, Plastic Base	\$89.95
HIM-HK-709	Straight Key, High Profile, Plastic Base	\$99.95
HIM-HK-808	Clear Cover Straight Key, High Profile, Marble Base	\$249.95
HIM-MK-701	Classic Iambic Paddle, No Base, Black Finger Piece	\$79.95
HIM-MK-705	Deluxe Iambic Paddle, Marble Base, Black Finger Piece	\$179.95
HIM-MK-706	Iambic Paddle, Black Steel Base, Black Finger Piece	\$139.95



GDK-807F

GHD Paddles and Straight Keys

DX Engineering is pleased to now offer exceptional Morse code iambic paddles and straight keys from GHD Telegraph Key, featuring chrome finishing, aircraft-quality bearings, and gold- and/or silver-plated contacts. Manufactured in Sendai, Japan, GHD keys are finely crafted instruments, combining form, function and long-lasting durability to create a satisfying CW operating experience, whether contesting or sharpening your coding skills.

GDK-GM702	Palm-Size, 5 oz. Travel Paddle	\$169.95
GDK-GT705A	GHD Straight Key	\$189.95
GDK-GN807F	Entry-Level Iambic Paddle	\$199.95
GDK-GN607F	Classic Iambic Paddle	\$269.95
GDK-GN507F	Large-Base Iambic Paddle	\$279.95
GDK-GT501A	"Finest Straight Key"	\$549.95

Palstar



CW50A Electronic Keyer

The Palstar CW50A Electronic Keyer has a speed control adjustable from 10 to 40 WPM, crystal-controlled for high accuracy. You can easily flip from mode A to mode B iambic keying and the built-in sidetone generator and speaker make monitoring your transmission easy. The CW50A also doubles as a training unit. Character spacing and dash weight are adjustable, as well.

The Palstar CW50A Electronic Keyer works with any straight key, semi-automatic bug key, single lever paddles and iambic dual lever "squeeze" paddles. Plus, it's compatible with both tube and solid state rigs. You can hook up your paddle through a convenient front panel jack, and there's a separate jack for your straight key—allowing for two keys to be attached at the same time. Read more details at DXEngineering.com.

• Sidetone pitch: 500-1000 Hz, front panel adjustable	
• Keying output: positive, negative and high-speed reed relay	
• Operating current: 10-50 mA, depending on sidetone level	
PAS-CW50A Palstar Electronic Keyer	\$369.99

AMERITRON



AME-ADL-2500



AME-ADL-1500

ADL-1500

Oil-Filled Dummy Load, 1,500 Watts

- 7 1/2" H x 6 5/8" D
- SWR under 1.2:1 to 30 MHz and low SWR to 400 MHz

AME-ADL-1500 Dummy Load, 1,500 Watts..... \$129.95

ADL-2500

Fan-Cooled Dummy Load, 2,500 Watts

- SWR under 1.25:1 below 30 MHz and under 1.4:1 from 30 to 60 MHz
- 4" H x 8 1/4" D

AME-ADL-2500 Dummy Load, 2,500 Watts..... \$319.95

DX ENGINEERING

RF Attenuator Pack

Ideal for testing receiving equipment, this pack of three inline attenuators (3, 6, and 10 dB) can be used to limit the RF input to your preamp to prevent overload or to pad the output of a high gain preamp to an appropriate level. Adding an inline attenuator to a receiver input lets you gauge the accuracy of S-meter readings on transceivers with a constant RF input signal source. These 1/2W 50 Ω attenuators include BNC male/female connectors.



DXE-ATTN-50-VP3 Pack of 3 RF Attenuators \$45.99

Orders over \$99 qualify for FREE standard shipping—see pg. 74 for details.



RF Directional Wattmeters

Once only available to broadcast engineers, wireless network designers and communications professionals, now you can get these high-precision Coaxial Dynamics meters for your own station. Simply connect the meter between your RF power source and your antenna (or dummy load), and with a few minor adjustments you'll be able to measure forward or reflected power.

Each meter requires plug-in elements to choose or expand the power and frequency range you want to measure, available at DXEngineering.com.

The meters are shock-mounted in a virtually indestructible chassis, making them well suited to the field. For extra protection, check out the Carrying Case. It is made specifically for the 81000 series meters, with room to fit four additional connectors and 11 separate plug-in elements.

- CXD-81000-ANF RF Directional Wattmeter, N Female Connectors **\$475.00**
- CXD-81000-AUF RF Directional Wattmeter, SO-239 Connectors **\$475.00**
- CXD-88800 Carrying Case **\$144.00**



CXD-81000-ANF



Coaxial Dynamics Standard Plug-In Elements

Expand the versatility of your Coaxial Dynamics or Bird Directional Wattmeter by using additional Plug-In Elements. They assure a super accurate measurement for your station power and antenna performance. Coaxial Dynamics' 7/8 inch line size standardization means these elements are completely interchangeable, whether the element is brand new, or if it were made decades ago.

Elements are available at DXEngineering.com.



VEC-DL650M

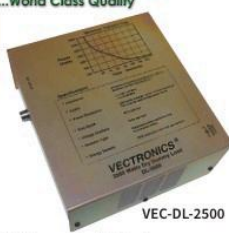

VEC-DL-2500

Dummy Loads

- Air-Cooled
- 1,500 Watts, 0-650 MHz
- SWR under 1.3:1 at DC-300 MHz, under 1.5:1 at 300-500 MHz, under 2.0:1 at 650-1000 MHz
- VEC-DL650M 1,500 Watts, SO-239 **\$139.95**
- VEC-DL-650MN 1,500 Watts, Type-N Female; **\$149.95**
- Fan-Cooled
- 2,500 Watts, 0-150 MHz
- SWR under 1.31 to 30 MHz
- VEC-DL-2500 Dummy Load, 2,500 Watts..... **\$299.95**



SX40C 300 Watt Mobile Power Meter

This compact meter works well in mobile rigs or base station installations that are short on space. Its cross-needle display indicates SWR and power output simultaneously. It features 30/300 watt min./max. power ranges. The flexible, nicely built SX40C covers 144-470 MHz and makes an excellent addition to your testing tools whether operating from your shack or outside.

- DMN-SX40C SX40C Mobile Power Meter, 2M-70cm **\$94.99**



DMN-SX40C



Diamond Compact Dummy Loads

- DMN-DL30A Compact Dummy Load, 15 W Avg./100 W Peak, DC-500 MHz, PL-259 **\$39.99**
- DMN-DL30N Compact Dummy Load, 15 W Avg./100 W Peak, DC-500 MHz, Type N Connector **\$59.99**



Digital SWR/Wattmeter

This meter's intuitive bar graph display combines digital accuracy with the easy readability of an analog meter. Use this meter to display power, SWR and frequency simultaneously. There's also an adjustable alarm to alert you to dangerous SWR levels. It covers 1.8-54 MHz with 25/250/1,500 watt min./mid./max. power ranges.

- MFJ-826B Digital SWR/Wattmeter **\$239.95**



Wattmeter

This hyper-accurate meter measures and displays SWR, forward power and reflected power simultaneously. It also monitors average power, and its handy "Peak Hold" buttons make it easy to record peak power. The meter covers 1.8-60 MHz with 300/2,000 watt min./max. power ranges. The PM2000A meter has a 0.090" iridite-treated aluminum case with a powdercoated front panel and top cover. Rear panel SO-239 (UHF female) connectors are provided for coaxial cable RF input and output.

- PAS-PM2000A Wattmeter, 2,000 Watts **\$349.99**



MFJ-267 Air-Cooled Dummy Load and Wattmeter, 1,500 Watts

- SWR under 1.3:1 at 30 MHz
- Built-in wattmeter can be used independently

- MFJ-267 Dummy Load/Wattmeter **\$239.95**



MFJ-267

MFJ-264 Air-Cooled Dummy Load, 1,500 Watts (SO-239)

- SWR under 1.1:1 at 30 MHz and 1.3:1 at 30-650 MHz

- MFJ-264 Dummy Load, 1,500 Watts..... **\$129.95**



MFJ-264

MFJ-264N Air-Cooled Dummy Load, 1,500 Watts (N Connector)

- SWR under 1.1:1 at 30 MHz and 1.3:1 at 30-650 MHz

- MFJ-264N Dummy Load, 1,500 Watts..... **\$139.95**

MFJ-260C Air-Cooled Dummy Load, 300 Watts

- SWR under 1.1:1 to 30 MHz and 1.5:1 at 30-650 MHz

- MFJ-260C Dummy Load, 300 Watts..... **\$69.95**



Monitor Sensors Logo



Power+SWR Meter

Monitor Sensors' highly regarded Power and SWR Meter delivers accurate RF power readings from 10mW up to 2,000W and SWR measurements at power levels as low as 50mW. This compact and reliable Australian-made meter has an easy-to-use design housed in a sturdy chassis that's a great choice for both high-powered stations or QRP operations. The meter works with CW, SSB, AM, FM, RTTY, and Digital modes. Features include 130 kHz-30 MHz coverage; 48 factory-set calibration points for greater accuracy; the ability to change LCD display backlighting color in relation to current SWR readings; protection against inadvertent reverse voltage connections; and a straightforward back panel with two UHF female SO-239 connectors for RF-in and RF-out, a 2.1mm 12 VDC power jack, and a two-pin connector with solid-state opto-isolated contacts for high SWR alarm or amplifier keying line interrupt. A DC power lead and high SWR alarm plug are included. Enter "Monitor Sensors" at DXEngineering.com for more details.

- MTN-SWRMETER Power+SWR Meter, 130 kHz-30 MHz **\$249.99**



DWA-CN-901HP3



DWA-CN-901HP

3,000 Watt Professional Series Bench Meter

- The CN-901HP3 covers 1.8-200 MHz with 30/300/3,000 watt min./mid./max. power ranges.
- DWA-CN-901HP3 3,000 Watt Professional Series Bench Meter **\$249.99**

2,000 Watt Professional Series Bench Meter

- The CN-901HP covers 1.8-200 MHz with 20/200/2,000 watt min./mid./max. power ranges.
- DWA-CN-901HP 2,000 Watt Professional Series Bench Meter **\$199.99**

200 Watt Professional Series Bench Meter

- The CN-901V covers 140-525 MHz with 20/200 watt min./max. power ranges.
- DWA-CN-901V 200 Watt Professional Series Bench Meter..... **\$187.99**



1,500 Watt Economy Series HF/VHF Bench Meter

- The CN-501H covers 1.8-150 MHz with 15/150/1,500 watt min./mid./max. power ranges.
- DWA-CN-501H 1,500 Watt Economy Series HF/VHF Bench Meter **\$137.99**



200 Watt Economy Series HF/VHF Bench Meter

- The CN-501V covers 140-525 MHz with 20/200 watt min./max. power ranges.
- DWA-CN-501V 200 Watt Economy Series HF/VHF Bench Meter **\$139.99**

Need help with your project? Call the tech line at 330-572-3200!



**Vector Power/
SWR Meters**

Metropwr

Featuring a modern design with many options for expanding functionality, these highly accurate digital meters from Metropwr combine a touchscreen auto-ranging wattmeter and RF coupler for measurements from 0.5W to 3kW, or 5kW PEP with optional FX5 coupler. A fast 32-bit processor plus a coprocessor handle measurements in real time, including power (AVG, PEP, dBm), SWR, return loss, R, Z, X, and much more. Their fast external bus allows for seamless connection of Metropwr optional accessories. Add one or two FX7 1x4 RF Switches to control four radios and/or four antennas. Meters feature 1.8-55 MHz coverage; large color touchscreen display (5" for FX773, 7" for FX775); high SWR alarm, RX/TX/standby; firmware updates and PC control through USB; and internal analog/digital UTC clock. Meters come with a 3kW FX3 coupler and two 5' male SMA patch cables for FWD/REV coupler connections. Dual inputs allow connection of one additional 3kW or 5kW coupler. Meter requires 13.8VDC. Enter "Metropwr" at DXEngineering.com for details and accessories.

- MWR-FX773-FX3 Power/SWR Meter, 5" LCD w/FX3 Coupler\$559.99
- MWR-FX775-FX3 Power/SWR Meter, 7" LCD w/FX3 Coupler\$729.99



MKR-21-922

VSWR/Power Meter

Moonraker offers a range of compact and accurate meters for measuring forward/reflected power and VSWR. Some models include a 13.8V DC lamp and power handling up to 400W.



MKR-21-410

- MKR-21-410 AV-20 VSWR/Power Meter, 1.8-200MHz, 15W/150W \$99.99
- MKR-21-412 AV-40 VSWR/Power Meter, 144-470MHz, 15W/150W \$99.99
- MKR-21-414 AV-200 VSWR/Power Meter, 1.8-160MHz, 5/20/200/400W \$119.99
- MKR-21-416 AV-400 VSWR/Power Meter, 140-525MHz, 5/20/200/400W \$119.99
- MKR-21-417 AV-600 VSWR/Power Meter, Sensor 1: 1.8-160MHz, Sensor 2, 140-525MHz, 5/20/200/400W \$149.99
- MKR-21-420 AV-1000 VSWR/Power Meter, 1.8-160MHz, 430-450MHz, 800-930MHz, 1240-1300MHz, 5/20/200/400W \$179.99
- MKR-21-920 SWR/Watt Meter, 120-500 MHz \$59.99

Dual-Function VHF/UHF SWR/Power Meter

The compact SWR-300 meter measures the SWR of a VHF/UHF antenna system from 120-500MHz and can also be employed to measure the forward and reflected power of a VHF or UHF radio from 0.5-100W. It comes with two UHF female SO-239 connectors.

- MKR-21-922 VHF/UHF SWR/Power Meter\$43.99

ELECRAFT



ECT-W2-A-200

W2 Wattmeters

Perfect for both QRO and QRP operators, Elecraft W2 Wattmeters provide fast, high-brightness independent LED bar graphs of power and SWR to easily keep track of transmitter, amplifier and antenna performance. These auto-ranging power/SWR meters feature two sensor inputs, PC remote connectivity, over-range alarm and amp keying control. These pre-assembled units include tested power couplers for 2/20/200W (200W models) and 20/200/2000W (2,000W models). Also available in a VHF/UHF 200W version. Free software download at keyword "Elecraft." Additional sensor available separately.

- ECT-W2-A-200 SWR/200W Wattmeter/Assembled, 1.8-54 MHz ...\$489.95
- ECT-W2-A-2000 SWR/2,000W Wattmeter/Assembled, 1.8-54 MHz ...\$489.95
- ECT-W2-A-V-U SWR/200W VHF/UHF Wattmeter/Assembled.....\$489.95

W2 Wattmeter Sensors

These 1.8-54 MHz dual directional coupler remote sensors are available to expand the functionality of your W2 Wattmeter. Add a sensor to cover a different power range. Choose from 0.1- 200 watt or 1-2000 watt models. Fully assembled and calibrated, not a kit.



ECT-DCHF-200A

- ECT-DCHF-2000A SWR/W2 Wattmeter Sensors 1-2000W.....\$199.95
- ECT-DCHF-200A SWR/W2 Wattmeter Sensors 0.1-200W.....\$199.95

ELECRAFT

USB Adapter Cable

DX Engineering now carries this special replacement USB interface cable (USB A to 3.5mm) for Elecraft's famous KX3 160-6M Transceiver, its XG3 Programmable Signal Source, and other equipment.



- ECT-KXUSB-A USB to 3.5mm TRS Adapter Cable.....\$39.95

AMERITRON

AME-ICP-240

ICP-120 & ICP-240 In-Rush Current Protectors

- Designed to stop damaging in-rush current
- Protect your tubes from thermal shock
- No complicated wiring, plugs right in to AC
- Not for use with motors (engines)

- AME-ICP-120 In-Rush Current Protector, 120 Vac\$119.95
- AME-ICP-240 In-Rush Current Protector, 240 Vac\$139.95

DIAMOND ANTENNA



Diamond Antenna Power Meters

SX400 200 Watt Power Meter DMN-SX200
Designed for VHF and UHF, this compact meter is perfect for mobile or base installations. It covers 140-525 MHz with 5/20/200 watt min./mid./max. power ranges.

- DMN-SX400 SX400 Power Meter\$116.99

SX200 200 Watt Power Meter

With a 4 watt minimum of testing power, this compact meter is perfect for testing 2M HT or base stations. It covers 1.8-200 MHz with 5/20/200 watt min./mid./max. power ranges.

- DMN-SX200 SX200 Power Meter\$104.99

SX600 Dual Power Meter

Instantly switch from metering one of two directional couplers. For low-band/VHF rigs there's a 1.8-160 MHz coupler and for VHF/UHF rigs, there's a 140-525 MHz coupler. Plus, the couplers are separate, which means you can keep both rigs plugged in all the time. The SX600 has 5/20/200 watt min./mid./max. power ranges.

- DMN-SX600 SX600 Dual Power Meter\$199.99

SX1100 Dual Power Meter

The ideal meter if you're operating on the 33cm and 23cm bands. Similar to the SX600, this meter has two separate couplers: one covers 1.8-160 MHz while the other UHF coupler covers 430-1300 MHz. The three UHF bands are selectable for 430-450, 800-930 and 1240-1300 MHz. The SX1100 has 5/20/200 watt min./mid./max. power ranges.

- DMN-SX1100 SX1100 Dual Power Meter\$267.99

AMERITRON

ARB-704 Amplifier/Transceiver Interface Buffer



- Protects your expensive radio from damage
- Works with almost any transceiver
- No moving parts, almost instant switching

- AME-ARB-704 Interface Buffer.....\$79.95
- AME-ARB-704I2 Interface Buffer with Cable for Icom 7000/760/718.....\$79.95

ARB-704 Interface Cables

These cables let you connect your specific transceiver to Ameritron's ARB-704 Interface Buffer. They are plug-and-play configurations that let you safely connect virtually any modern transceiver to your ARB-704.



Part Number	Radio	Description	Price
AME-PNP-7DI	Icom	7-Pin DIN	\$29.95
AME-PNP-8DI	Icom	8-Pin DIN	\$29.95
AME-PNP-13D	Icom	13-Pin DIN	\$29.95
AME-PNP-7D	Kenwood	7-Pin DIN	\$29.95
AME-PNP-8MK	Kenwood	8-Pin Mini-DIN	\$29.95
AME-PNP-5M	Yaesu	5-Pin Mini-DIN	\$29.95
AME-PNP-8D	Yaesu	8-Pin DIN	\$29.95
AME-PNP-8M	Yaesu	8-Pin Mini-DIN	\$29.95
AME-PNP-10MY	Yaesu	10-Pin Mini-DIN	\$29.95
AME-PNP-DB15Y	Yaesu	DB15M	\$29.95

Ameritron Amplifier Modification Kits

Add 10 and 12 meter band coverage to your Ameritron amplifier. Proof of U.S. Amateur License is required when purchasing 10 meter modification kits. Be sure to check your amplifier's serial number for modification compatibility before you order.



Part Number	For Amp Model	Serial Number	Price
AME-MOD-10M	ALS-500M, 600	12521 & -	\$59.95
AME-MOD-10MB	ALS-600, 600S	12522 & +	\$59.95
AME-MOD-10MK	ALS-1300	Any	\$79.95

Orders by 10 pm ET ship the same day. See pg. 74 for details.



RF Vacuum Tubes

For special RF power replacement vacuum tubes to fix a current amplifier, revive a legacy model, or build a new one, choose Penta Laboratories. Penta tubes are burned in for a minimum of 48 hours, dissipating full power with filament, plate, and screen voltages that are normally used in amp applications. This ensures electrical parameters are stable and will perform as expected during their lifetime. Tubes are evaluated on WT-100A original RCA production testers for plate current, screen current, and transconductance.

FU-728F Tetrode RF Vacuum Tube for OM Power Amps

FU-728F ceramic tetrode tubes are available for replacing tubes used in OM Power linear amplifiers, including OM2000+, OM2000A, OM2500, and OM4000 models.

PLB-FU-728F FU-728F Single..... **\$1,599.99**

3-500ZG Hi-Mu Power Triode RF Vacuum Tube

The 3-500ZG has a maximum plate dissipation rating of 500W and is intended for use as a zero-bias Class AB2 amplifier. When operated in a cathode-driven circuit, a power gain of as much as 20 times is achievable. It features a ceramic base for better temperature control. Radiation and forced air provide cooling through the base, along the envelope, and over the plate seal and plate connector.

PLB-3-500ZG 3-500ZG Single..... **\$299.99**

PLB-3-500ZG-2 3-500ZG Matched, Set of 2..... **\$599.99**

PLB-3-500ZG-3 3-500ZG Matched, Set of 3..... **\$899.99**

PLB-3-500ZG-4 4-500ZG Matched, Set of 4..... **\$1,199.99**

572B Power Triode RF Vacuum Tube

The 572B is for use as an RF oscillator, RF power amplifier, and audio frequency modulator. It's a direct replacement for the 811A but comes with a graphite anode for increased performance and reliability.

PLB-572B 572B Single..... **\$98.99**

PLB-572B-2 572B Matched, Set of 2..... **\$189.99**

PLB-572B-3 572B Matched, Set of 3..... **\$279.99**

PLB-572B-4 572B Matched, Set of 4..... **\$369.99**

811A Hi-Mu Power Triode RF Vacuum Tube

The 811A is for use as an audio frequency amplifier or modulator, RF amplifier, or oscillator. It is capable of outputting up to 160 watts at frequencies up to 30 MHz.

PLB-811A 811A Single..... **\$48.99**

PLB-811A-2 811A Matched, Set of 2..... **\$97.99**

PLB-811A-3 811A Matched, Set of 3..... **\$146.99**

PLB-811A-4 811A Matched, Set of 4..... **\$195.99**

3CX800A7 Power Triode Ceramic RF Vacuum Tube

This tube is for use as a cathode-driven Class AB2 or Class B amplifier in RF applications, including VHF. Useful to 450 MHz, the 3CX800A7 delivers 750 watts PEP and 750 watts key-down CW output power to 350 MHz. Its anode is forced-air cooled for 800 watts of dissipation.

PLB-3CX800A7 3CX800A7 Single..... **\$899.99**

PLB-3CX800A7-2 3CX800A7 Matched, Set of 2... **\$1,799.99**

3CX1500A7 Ceramic and Metal Hi-Mu RF Vacuum Tube

This tube is for use as a cathode-driven Class AB2 or Class B amplifier in audio or RF applications including VHF, or as a cathode-driven, plate-modulated Class C RF amplifier. It has a maximum plate dissipation rating of 1,500 watts and maximum CW output power to 250 MHz.

PLB-3CX1500A7 3CX1500A7 Single..... **\$1,499.99**

4CX1000A Ceramic Low-Voltage, High-Current Radial-Beam Power Tetrode RF Vacuum Tube

This tube is for Class AB1 RF linear amplifier or audio amplifier applications. It has a maximum plate dissipation rating of 1,000 watts and maximum CW output power to 110 MHz.

PLB-4CX1000A 4CX1000A Single..... **\$1,299.99**

4CX800A-T Ceramic Thompson Brand Power Tetrode RF Vacuum Tube

This GU74B equivalent features a maximum plate dissipation rating of 800 watts.

PLB-4CX800A-T 4CX1000A Single..... **\$999.99**



ALS-600 & ALS-600S Solid State Linear Amplifiers

ALS-600 Solid State Linear Amplifier

- Coverage: 1.5 to 22 MHz (10-12 meters with optional install kit)
- Power output: ♦ 600 watts PEP ♦ 500 watts CE
- (4) rugged TMOS RF power FETs
- Quiet, low-speed, low-volume fan
- Instant bandswitching, no tuning required*

AME-ALS-600 Includes 120/220 Vac 50/60 Hz power supply Solid State Linear Amplifier **\$2,599.95**

AME-ALS-600S Includes lightweight switching power supply Solid State Linear Amplifier **\$2,399.95**

*With ARI-500 (not included)



AL-811H Linear Amplifier

- Coverage for 811H and 811 Amps: all HF bands (user-modifiable to 10/12 meters)
 - ♦ 800 watts PEP SSB
 - ♦ 600 watts CW
 - ♦ 400+ watts RTTY, SSTV, FM and AM

- Tube complement: (4) rugged, neutralized 811A transmitting tubes
- Transmit LED
- Operate/Standby switch

AME-AL-811H Linear Amplifier **\$1,499.95**

AL-811 Linear Amplifier

- Power output:
 - ♦ 600 watts PEP SSB
 - ♦ 500 watts CW
 - ♦ 400 watts RTTY, SSTV, FM and AM
- Tube complement: (3) rugged, neutralized 811A transmitting tubes

AME-AL-811 Linear Amplifier **\$1,399.95**



ATP-102 Deluxe Amplifier Tuning Pulser

- Relieves stress on amps, tuners and dummy loads during tuning
- Works with any solid state transceiver or transmitter
- Front panel adjustment controls

AME-ATP-102 Deluxe Amplifier Tuning Pulser; **\$119.95**



Automatic Bandswitching Radio Interface

Connect this between your Ameritron ALS-Series Solid State Amplifier and transceiver, and it will automatically select the right frequency range for your amp based on the band you're using. It works with most Icom, Kenwood and Yaesu transceivers, and there's a full complement of interface cables available for easy hookup.

AME-ARI-500 Automatic Bandswitching Radio Interface **\$139.95**

ARI-500 Interface Cables-These cables let you connect your specific transceiver to the ARI-500 and your amplifier.

Part Number	Radio	Description	Price
AME-RJ-DB15HE	Elecraft	K3 (BCD)	\$39.95
AME-RJ-7DI	Icom	7-Pin DIN	\$39.95
AME-RJ-13D	Icom	13-Pin DIN	\$39.95
AME-RJ-DB98MK	Kenwood	8-Pin Mini-DIN	\$39.95
AME-RJ-8MY2	Yaesu	8-Pin Mini-DIN	\$39.95



AME-ALS-600S



Solid State HF Power Amplifiers

- Coverage: all amateur bands, 1.8-54 MHz
- No tuning required
- Power output: 1,200W and 600W PEP models
- Quiet, low-speed fan
- RF TMOS MRF-150 FETs
- 120/240 VAC compatible
- Instant band changing—no warmup
- Manual or Auto band switching and keying with optional cable

AME-ALS-1306 Solid State, No-Tune 1.2 kW HF Power Amplifier **\$3,999.95**

AME-ALS-606S Solid State, No-Tune SMPS 600W HF Power Amplifier..... **\$2,599.95**

AME-ALS-606 Solid State, No-Tune 600W HF Power Amplifier **\$2,799.95**



Band Data Interface Cables for ALS-1306, ALS-606, ALS-606S



AME-DB-DB7DK AME-DB-DB8MK

Take advantage of the automatic band changing capability of Ameritron's ALS-1306, 606, and 606S HF Power Amplifiers or RSC-12C Remote Antenna Switch. You'll need the right cable to connect your radio. Find specific radio applications at DXEngineering.com.

Part Number	Radio Brand	Description	Price
AME-DB-DB15HE	Elecraft	K3 ACC DB15	\$39.95
AME-DB-7DI	Icom	7-Pin DIN ACC 2	\$39.95
AME-DB-13D	Icom	13-Pin DIN ACC	\$39.95
AME-DB-DB7DK	Kenwood	7-Pin DIN and RS232	\$39.95
AME-DB-DB8MK	Kenwood	TS-480SAT/HX	\$39.95
AME-DB-8DY	Yaesu	8-Pin DIN Band Data	\$39.95
AME-DB-8MY2	Yaesu	8-Pin Mini-DIN	\$39.95
AME-DB-10MY	Yaesu	FT-450, -950, -DX1200	\$39.95
AME-DB-DB15Y	Yaesu	FT-DX3000	\$39.95



AL-80B Linear Amplifier

- Coverage: all HF bands (user-modifiable to 10/12 meters)
- Power output:
 - ♦ 1,000 watts PEP SSB
 - ♦ 800 watts CW
 - ♦ 500 watts RTTY, SSTV, FM and AM
- Tube: (1) genuine, warranted 3-500ZG transmitting tube
- In-rush current protection
- Multi-voltage power transformer

AME-AL-80B Linear Amplifier..... **\$2,299.95**



ALS-1406 HF-6M LDMOS Amplifier

This solid state amp features 1.5-54 MHz coverage, 1,200W PEP output, two LDMOS transistors designed to handle high SWR, instant automatic band switching (with optional interface cable), no tuning, no warmup, advanced SWR protection, quiet variable-speed cooling, front panel band/error LEDs, PEP FWD/REF metering, external 240VAC switching power supply, and more. Enter "ALS-1406" at DXEngineering.com for details.

AME-ALS-1406 LDMOS Amplifier..... **\$3,499.00**



New!

Need advice? 1-330-572-3200 or DXEngineering@DXEngineering.com



1,500 Watt Automatic HF Linear Amplifier

This is the first Amateur Radio HF amplifier to combine fully automatic tuning and sophisticated digital control capabilities. The 2000A delivers up to 1,500 watts of clean, noise-free power. Full automatic tuning gives contesters an edge by permitting lightning-quick bandswitching with low SWR. Advanced digital features provide full control via PC when plugged into the 2000A's RS232 port. An optional module lets you turn the amplifier on and off remotely. The ASW-120 Remote Antenna Switch and Selector Console provides complete antenna selection automation when interfaced with the 2000A, or it may be used as a manually- or PC-controlled antenna switching system. Order the AOM-2000A model to wire the AC plug yourself; order the AOM-2000A-240 for pre-wired 240 volt operation, tested by our techs.

- AOM-2000A 1,500 Watt Automatic HF Linear Amplifier.....**\$7,929.99**
- AOM-2000A-240 Acom-2000A with Pre-Wired 240V AC Plug.....**\$8,004.99**
- AOM-RPON Remote Power On Module for 2000A**\$199.99**
- AOM-ASW-120 10 Port 5kW Remote Antenna Switch and 2000S Selector Console.....**\$959.99**

Remote Control Unit

This is the same remote control unit that comes with ACOM's 2000 amplifier. The unit lets you install the amplifier away from your desk and free up space in your shack. You can control all amplifier functions and monitor critical parameters on the large LCD display.

- AOM-RCU-TFT Remote Control Unit.....**\$979.99**

Transceiver to Amplifier Interface and Keying Cables

The proper amplifier-to-radio link is essential to using all of the amplifier's functions (like band switching and keying). Make sure you're getting the most out of your setup with the application-specific interface cables. The amplifier and radio manufacturer are listed in the table below, a comprehensive rundown of model compatibility is at DXEngineering.com.



Part Number	Radio	Amplifier	Cable Description	Price
DXE-2000-ICO-5	Icom	ACOM 2000A	Icom C-IV Remote Port	\$55.99
DXE-2000-KWD-5	Kenwood	ACOM 2000A	RS-232 Com Port	\$55.99
DXE-2000-YSU-5	Yaesu	ACOM 2000A	RS-232 CAT	\$55.99
DXE-2000-K3-5	Elecraft K3	ACOM 200A	DB-9 Connector	\$55.99
DXE-ACOMSS-ICO	Icom	ACOM 600/700/1200S	Icom C-IV Remote Port	\$55.99
DXE-ACOMSS-101	Yaesu	ACOM 600S/700S/1200S	To FTdx-101D/MP	\$64.99
DXE-ACOMSS-KWD	Kenwood	ACOM 600/700/1200S	RS-232 Com Port	\$55.99
DXE-ACOMSS-YSU	Yaesu	ACOM 600/700/1200S	RS-232 CAT	\$55.99
DXE-ACOMSS-YSU10	Yaesu	ACOM SS	ACOM SS to Yaesu 10-Pin Mini, BCD/PTT Keying	\$55.99
DXE-ACOMSS-K3	Elecraft	ACOM 600/700/1200S	DB-9 Connector	\$55.99
DXE-KWD-RCA	Kenwood	Universal	Keying, RCA to 7-Pin DIN	\$51.99
DXE-KWD-SS-RCA	Kenwood	SS Amps	SS to 7-Pin DIN	\$36.99
DXE-KWD-8P-RCA	Kenwood	Universal	8-Pin Mini DIN to RCA	\$41.99
DXE-YSU-8P-RCA	Yaesu	Universal	8-Pin Mini DIN to RCA	\$45.99
DXE-YSU-10P-RCA	Yaesu	Universal	Yaesu 10-Pin Mini to RCA	\$37.99
DXE-YSU-10PMD-UN	Yaesu	Universal	DIY 10-Pin Mini DIN to Undetermined Wires	\$25.99



700 Watt HF+6M Linear Amplifier

The 700S Solid State 1.8-54 MHz Linear Amplifier is the latest addition to ACOM's state-of-the-art lineup of 160 through 6 meter amplifiers. This rugged, compact and lightweight device makes a great choice for field operations, DXpeditions and at your home station. Operators will enjoy 700W of output power (PEP SSB, CW and digital modes); intuitive, easy-to-follow screen menus which simplify operation—no special skills are required with RF sense automatic band changing; full output operation that only requires a maximum of 40W drive; and protection circuits that continually safeguard the amplifier while operating in any mode. The 700S is compatible with all available transceiver models on the market. The broadband input matches to the transceiver with low SWR over the entire range of 1.8-54 MHz.

Order your Acom amplifiers with the custom 120V or 240V AC plug already installed.

- AOM-700S 700W HF-6M Linear Amplifier**\$3,859.99**
- AOM-700S-120 Acom-700S with Pre-Wired 120V AC Plug**\$3,934.99**
- AOM-700S-240 Acom-700S with Pre-Wired 240V AC Plug**\$3,934.99**



1,000 Watt HF+6M Linear Amplifier

Answering the call from Hams who want a state-of-the-art, solid state RF amplifier with full HF and 6 meter coverage, ACOM introduces its 1200S. It's very compact and rugged, making it a smart choice for DXpeditions. The final PA stage uses a rugged LDMOS transistor, and a large color display features intuitive menus and on-board monitoring of 10 parameters. It's compatible with virtually all modern radios, requiring less than 50 watts of drive power.

- AOM-1200S 1,000 Watt HF+6M Linear Amplifier**\$4,199.99**

Order your Acom amplifiers with the custom 120V or 240V AC plug already installed.

- AOM-1200S-120 Acom-1200S with Pre-Wired 120V AC Plug**\$4,274.99**
- AOM-1200S-240 Acom-1200S with Pre-Wired 240V AC Plug**\$4,274.99**



1,500 Watt Automatic HF+6M Linear Amplifier

Combining ease of use and serious pileup-busting capabilities, this solid-state 160 through 6 meter amplifier delivers maximum legal power in all modes, plus operator-friendly functionality thanks to its remote control unit with high-resolution LCD screen. Compatible with all transceiver models, the 2020S is designed with isolated input and output ports, reducing intermodulation and improving resistance to self-excited oscillation. A broadband input circuit provides a perfect transceiver load with SWR below 1.2 without re-tuning throughout the entire frequency range, and built-in intelligence provides continuous monitoring of system health and protection circuits. Operators benefit from intermodulation distortion better than 30 dB below rated PEP, and harmonic and parasitic emissions output suppression better than 60 dB (1.8-29.7 MHz) and 70 dB (50-54 MHz) below rated output. The Acom 2020S supports direct remote control via the Internet with an integrated web interface and built-in Ethernet RJ45 LAN port or Wi-Fi adapter. Enter "2020S" at DXEngineering.com for more details.

- AOM-2020S 1,500 Watt Automatic HF+6M Linear Amplifier.....**\$7,859.99**
- AOM-2020S-240 Acom 2020S with Pre-Wired 240V AC Plug.....**\$7,934.99**

We're All Elmers Here! Get Expert Support at: Elmer@DXEngineering.com

ACOM *New!*

500 Watt 160-4M Linear Amplifier

With output power of 500W (PEP or Digital) and coverage from 1.8 through 70.5 MHz, this user-friendly, compact (11.5" W x 6.2" H x 10.6" D), and lightweight (17.20 lbs.)

RF power amplifier is great for DXpeditions and field ops. The built-in switching-mode power supply operates with an extended mains voltage range of 100-240 VAC, with no internal switch over. A rugged LDMOS transistor and broadband input circuit present an SWR below 1.5 without retuning throughout the frequency range. Features include two antenna outputs, intelligent protection circuits, frequency filters that exceed EMC requirements, and integration with ACOM 04AT/06AT tuners. Note that 4M operation is not authorized in the U.S. and many other countries. Legal operation is the responsibility of the user.

- AOM-500S 500W 160-4M Linear Amplifier**\$3,399.99**
- Order your Acom amplifiers with the custom 120V or 240V AC plug already installed.**
- AOM-500S-120 Acom-500S with Pre-Wired 120V AC Plug**\$3,474.99**
- AOM-500S-240 Acom-500S with Pre-Wired 240V AC Plug**\$3,474.99**



1,500 Watt HF Linear Amplifier

The user-friendly 2100 uses a powerful tuning aid and automatic input attenuator to let you quickly match the input impedance to the tube load impedance. As long as the VSWR stays under 3:1, you won't need an antenna tuner. A good choice for Field Day, EMCOMM and base stations, the 2100 is packed with self-protection features and will withstand up to 400 watts of reflected power. It boasts intuitive controls and OLED display for straightforward operation. Order the AOM-2100 model to wire the AC plug yourself; order the AOM-2100-240 for pre-wired 240 volt operation, tested by our techs.

- AOM-2100 1,500 Watt HF Linear Amplifier.....**\$5,039.99**
- AOM-2100-240 Acom-2100 with Pre-Wired 240V AC Plug.....**\$5,114.99**



ACOM **1,000 Watt HF+6M Linear Amplifier**

Easy to operate and easy to maintain, ACOM's A1000 is an extraordinary good value for HF operators. You can switch bands without a tuner, provided VSWR stays below 3:1. That gives you an edge during a contest scramble. Broadband input matching means that your radio will always see a very good load across the entire 1.8-54 MHz spectrum. Specially mounted relays deliver virtually silent QSK operation. This amplifier can also withstand significant amounts of reflected power and signal fluctuations.

- AOM-1000 1,000 Watt HF Linear Amplifier**\$3,849.99**
- Order your Acom amplifiers with the custom 120V or 240V AC plug already installed.**
- AOM-1000-120 Acom-1000 with Pre-Wired 120V AC Plug**\$3,924.99**
- AOM-1000-240 Acom-1000 with Pre-Wired 240V AC Plug**\$3,924.99**



1,500 Watt HF+6M Linear Amplifier

Enjoy the Acom 1500's HF+6M coverage; low distortion and noise figures; fast and easy adjustments with its large, smooth knobs and sleek LCD screen; three antenna outputs; nearly silent input bypass and antenna relays; and diagnostic data stored in one of seven nonvolatile memory banks. Order the AOM-1500 model to wire the AC plug yourself; order the AOM-1500-240 for pre-wired 240 volt operation, tested by our techs.

- AOM-1500 1,500 Watt HF Linear Amplifier **\$4,539.99**
- AOM-1500-240 Acom-1500 with Pre-Wired 240V AC Plug **\$4,614.99**



ACOM **700 Watt HF Linear Amplifier**

As long as the VSWR stays below 3:1, this amplifier lets you change between the 160 and 10 meter bands without using an external tuner. The A1010 can withstand up to 240 watts of reflected power, up to 100 milliseconds of drive spikes and deep voltage drops. Its durability and front-panel controls make this amplifier an excellent choice.

- AOM-1010 700 Watt HF Linear Amplifier **\$2,959.99**
- Order your Acom amplifiers with the custom 120V or 240V AC plug already installed.**
- AOM-1010-120 Acom-1010 with Pre-Wired 120V AC Plug **\$3,034.99**
- AOM-1010-240 Acom-1010 with Pre-Wired 240V AC Plug **\$3,034.99**



eBox Ethernet Remote Control Devices

The easy-to-operate eBox is an active Ethernet device which directly integrates Acom power amplifiers to the Ethernet networks. These units have been specifically designed for remote control use with the Acom 600S, 700S, 1200S, and 2000A with Remote Control Unit (RCU). The eBox receives specific commands via a web browser-based, user-friendly interface and forwards them to the Acom amplifier. The eBox is compatible with all popular operating systems and web browsers (Chrome, Opera, Firefox, MS Edge, Safari, et. al.). Universal wall supply with Euro-US plug adapter included.



- AOM-EBOX-2000-P eBox with Cable for Acom 2000A with RCU.....**\$607.98**
- AOM-EBOX-SS-P eBox with Cable for Acom 600S/700S/1200S.....**\$607.98**

DX ENGINEERING



DXE-3RIGKEYLINE



DXE-KEYLINE-DUAL



DXE-KEYLINE-3

Transceiver Key Line Splitters and Combiners

Choose from three different Key Line Splitters and Combiners for the "ground-on-transmit" amplifier keying line of one or multiple transceivers to key one or more accessories or amplifiers safely, without interaction. They are passive DC-only devices that require no power and provide multiple PTT keying line outputs, inputs or both. All four connectors are female RCA phono. Center conductor grounding to the shield of any one of the PTT IN connector(s) provides the same diode protected center conductor grounding to the shield of the PTT OUT connector(s). For example:

- KEYLINE-3 is a splitter for one transceiver to key one amp and two accessories.
- 3RIGKEYLINE is a combiner for up to three transceivers to key one amplifier.
- KEYLINE-DUAL is a combiner-splitter for two transceivers to key two amplifiers, or one amplifier and one accessory.

These devices are really handy when using Amateur Radio devices that need to "share" a T/R keying line and don't have a keying line pass-through. Each keying input or output is guarded with a separate 60V 2A Schottky diode, providing ground-on-transmit isolation between each accessory keying line. They keep the load or voltage of any one piece of equipment from affecting the others. Their voltage and current handling depends upon the rating of the transceiver(s) transistor or relay amplifier keying circuit. Check your transceiver manual for the total voltage and current that it will safely handle. These devices handle keying lines only. Other connections and appropriate amplifier and accessory operation must be considered.

- DXE-KEYLINE-3 PTT Key Line Splitter, 1 Input, 3 Outputs.....**\$79.99**
- DXE-3RIGKEYLINE PTT Key Line Combiner, 3 Inputs, 1 Output.....**\$77.99**
- DXE-KEYLINE-DUAL PTT Key Line Combiner-Splitter, 2 Inputs, 2 Outputs.....**\$79.99**

Visit DXEngineering.com for the latest limited-time offers and special savings!



OMR-OM4001HFMARS



OMR-OM-4001HF



OMR-OM-2000A



OMR-OM-2000-MARS



OMR-OM-4001A



1,500W+ Manual and Auto Tune Linear Amplifiers

DX Engineering is the exclusive North American distributor of products from OM Power, a company that has been producing high-performance, tube-style linear amplifiers for contesting and DX stations worldwide since 2004. OM Power's compact HF, HF+6, HF+MARS, and HF+6+MARS amplifiers feature one or two FU-728F tetrode tubes capable of providing stable, full legal-limit all-mode output power; 4.3" color touchscreen; easy maintenance; efficient cooling; simplified troubleshooting; advanced safeguards against high SWR, excessive current, and more; full break-in CW capability; and for auto tune models, built-in band change or frequency reading capability for modern rigs, RF sense band change support for legacy transceivers, and remote control operation via LAN and PC program download. Note that legal operation of any linear amplifier within the applicable regional or country amateur radio regulations is the responsibility of the licensed operator. Find more OM Power amplifiers at DXEngineering.com.

Manual Tune Linear Amplifiers

OMR-OM-2000	160-10M + 6M, Manual Tune, 1 FU-728F Tube	\$4,329.99
OMR-OM-4001HF	160-10M, Manual Tune, 2 FU-728F Tubes	\$6,524.99
OMR-OM-2000-MARS	160-10M + 6M + MARS, Manual Tune, 1 FU-728F Tube	\$5,724.99
OMR-OM4001HFMARS	160-10M + MARS, Manual Tune, 2 FU-728F Tubes	\$8,374.99

Auto Tune Linear Amplifiers

OMR-OM-2000A	160-10M, Auto Tune, 1 FU-728F Tube	\$6,349.99
OMR-OM-4001A	160-10M Auto Tune, 2 FU-728F Tubes	\$8,499.99
OMR-OM-4001AMARS	160-10M + MARS Auto Tune, 2 FU-728F Tubes	\$10,349.99



RMY-HLA-305V



RMY-MLA100



RMY-MUA100



RMY-LA-250V



RMY-LA-145



HF and VHF Amplifiers

For over 40 years, RM Italy has made versatile and compact amplifiers for base, mobile and handheld radios. By controlling every phase of the manufacturing process, RM Italy is able to maintain incredibly high quality standards and capitalize on opportunities for innovation. These LA-250/305(V) VHF and HLA-305(V) HF solid state amplifiers are a smart choice for operators using a mobile or portable radio. The LA-144/145 models are a great way to maximize your HT's operating reach.

Part Number	Frequency Coverage	Max. Input Power	Max. Output Power (PEP)	Operating Modes	Interface	Cooling	Price
RMY-LA-250	2 Meters	25 Watts	200 Watts	AM, FM, SSB, CW	Mode Select, LCD Screen	Heat Sink	\$679.99
RMY-LA-250V	2 Meters	25 Watts	200 Watts	AM, FM, SSB, CW	Mode Select, LCD Screen	Fans	\$729.99
RMY-HLA-305V	160-10 Meters	10 Watts	200 Watts	AM, FM, SSB, CW, RTTY, Digital	Band and Mode Select, LCD Screen	Fans	\$859.99
RMY-LA-144	2 Meters	4 Watts	60 Watts	AM, FM, SSB, CW	SSB/FM Select	Heat Sink	\$159.99
RMY-LA-145	2 Meters	5 Watts	85 Watts	AM, FM, SSB, CW	SSB/FM Select	Heat Sink	\$199.99
RMY-MUA100	70cm	5 Watts	100 Watts	AM, FM, SSB, CW	SSB/FM Select	Fan	\$599.99
RMY-MLA100	160-10M+6M	10 Watts	100 Watts	AM, FM, SSB, CW, Digital	Band Select	Heat Sink	\$759.99
RMY-MLA100V	160-10M+6M	10 Watts	100 Watts	AM, FM, SSB, CW, Digital	Band Select	Fans	\$809.99

Prices are subject to change without notice.



Wideband HF+6M Linear Amplifier

This popular and versatile amplifier comes loaded with a host of Ham-friendly benefits. The BLA600 is a fully automatic wideband compact linear amplifier that covers all the HF bands and 6 meters, from 1.8 to 54 MHz. The unit delivers up to 500 watts SSB PEP and features dual MCU controls for protection against high RF input driver levels, high output VSWR, overcurrent and more. Its dual large diameter MCU-controlled multispeed fans keep it cool and running at peak efficiency. For CW QSK operation, the BLA600 provides fast and silent PIN diode switching that makes it a perfect companion in your shack. Its rugged 50V Freescale MRFE6VP5600H power transistors deliver high reliability and consistent high linear RF output. The low-noise amplifier also includes 3 user-configured teflon-insulated antenna output sockets, 2 x 16 LCD display to view amplifier status, and built-in heavy-duty AC power supply.

RMY-BLA600 Wideband Linear Amplifier...\$2,799.99



BLA350 Plus HF Linear Amplifiers

These compact, fully automatic units feature up to 300W output at less than 12W input on the 160 through 10 meter bands. Operators can take advantage of the BLA350's two 50Vdc MACOM MRF150 RF Power FETs that can be automatically or manually switched to one of six low pass filters, providing more than 50 dB of harmonic suppression. Fast hardware protection circuits safeguard the power transistors in the event of high SWR on the antenna feedline. The BLA350 Plus may be used on all narrow band modes of transmission, including SSB, CW, AM, FM, RTTY and FT8. A 16-character LCD display shows amplifier operating parameters including frequency, filter selection, and PA temperature.

RMY-BLA350P-120 300W HF Linear Amplifier, 110-120 Vac.....\$1,099.99

RMY-BLA350P-240 300W HF Linear Amplifier, 207-244 Vac.....\$1,099.99



IC-PW2 HF/50 MHz ALL Band 1 kW Linear Amplifier Reservation

Reserve your spot in line for Icom's exciting new IC-PW2 Linear Amplifier. This HF/50 all band unit features:

- The latest LDMOS that effortlessly provides 1 kW output at full duty cycle, even for extended periods of time
- Six antenna connectors and two radio inputs that allow the IC-PW2 to operate SO2R—Single Operator Two Radio Operation
- LAN port for remote control operation from a PC
- Touch screen color TFT LCD for intuitive setting changes
- Low-distortion output

+ When this new amplifier becomes available you will be entitled to a first right of refusal on a first come, first served basis. Once this amplifier has received FCC Type Certification and is offered for sale by Icom, with officially announced pricing, you will be contacted by DX Engineering to complete your order. Should you choose not to complete your IC-PW2 order, your non-refundable reservation deposit will be converted to a Gift Card that you can use toward any product offered by DX Engineering. Your reservation fee will be applied to the total Icom IC-PW2 purchase price at sale completion. When the amplifier becomes available, orders for the IC-PW2 will be shipped in the order that reservations were received.

RSV-IC-PW2 HF/50 MHz Linear Amplifier Reservation.....\$35.00

Wideband UHF Amplifier

Take your UHF operation to the next level with this compact linear amplifier. The unit measures 4.7" W x 1.6" H x 9.8" D and is ideal for low-power handheld operation. It features 405-480 MHz coverage and required input drive from 1 to 5 watts, which delivers a nominal 60 watts of full output power, 70 watts of PEP maximum. Other perks include automatic "RF Sense" switching between RX and TX, small transmit-recvie delay for smoother voice operation, and a rear panel European-style removable DC power connector cable for easy installation with a user-supplied power cable fused for 15A at 13.8 VDC.



RMY-LA-435 Wideband UHF Amplifier..... **\$399.99**

350W and 180W VHF RF Power Amplifiers

The PA-350V VHF 135-165 MHz 350W Power Amplifier is an advanced and versatile high-power linear amp designed for commercial VHF or amateur radio 2M FM, SSB and CW operations. A large, easy-to-read green backlit alphanumeric LCD provides simultaneous digital input power, output power, and SWR readings. Front panel button actions and specialized, user-defined function readouts and menu selections are displayed, including incremental 100, 200, 300 and 350W power output settings. This VHF amplifier delivers approximately 300 watts output with only 5 watts input from an HT or 350 watts maximum output with a VHF mobile. The PA-350V has two selectable input ranges, Low 15W max and High 30W max, achieving 350 watts output with either 10 watts input or 15 to 25 watts input, to accommodate almost any VHF transceiver. Other features include multiple protection circuits, a receive low-noise preamplifier with bandpass filter, RF sense or PTT keying, and thermostatically controlled fans. Requires 13.8 VDC at 50A max. External power supply not included. The PA-180V VHF 138-174 MHz 180W Power Amplifier features dual MOSFET push-pull PAs that provide full RF output of 180 watts with only 5 watts input, making this amplifier useful for both handheld and compatible mobile VHF transceivers. Mode, RX preamp, SWR meter and output settings of 60, 100, 140 and 180 watts are front panel selectable. The front panel multi-color eight-LED string indicates output power settings, output power, SWR and error. A unique shroud enables the oversize fan to quietly cool this compact amplifier for safe long-term operation at full output. Requires 13.8 VDC at 30A max. External power supply not included. Enter "Toptek" at DXEngineering.com for details on all Toptek amplifiers.



TEK-PA-350V VHF RF Power Amplifier, 350W **\$879.99**
 TEK-PA-180V VHF RF Power Amplifier, 180W **\$449.99**
 DMV-Y-ADAPT-3 Y-Adapter Separator Cable for Amplifier Keying, 5.9' **\$5.99**

150W UHF RF Power Amplifier

The PA-150U delivers reliable performance for FM, SSB, CW and digital mode operation, making it a perfect choice for commercial or amateur UHF operators. Weighing only 6.6 lbs., this two-stage 430-470 MHz, 150W output model (only 2 to 5 watts input drive) comes with heatsink chassis with cooling fans; built-in low-noise receive preamplifier with band pass filtering (nominal 10 dB gain); automatic fault protection for SWR over 2:1; digital multimeter; Low, Medium 100W and High 150W steps; RF sense keying for FM mode; and ultimate SSB maximum 5W PEP input, 170W PEP output. Pushbutton controls provide easy operation and long-lasting performance.



TEK-PA-150U UHF RF Power Amplifier, 150W..... **\$739.99**

85W VHF RF Power Amplifier

Weighing only 2.5 lbs. and measuring 4.9" W x 2" H x 8.3" D, the PA-85V features nominal output of 80-95W with 3 to 5 watts input drive on any frequency from 137-174 MHz. It features many perks of other Toptek models, including front panel power and SWR metering; automatic fault for high SWR over 2:1; RF sense keying for FM; PTT 3.5mm connector for SSB/CW; mode switch for automatic SSB delay and peak power metering; and built-in low-noise receive preamplifier. Maximum 5W input/95W output, with amp-off maximum bypass of 50W.



TEK-PA-85V VHF RF Power Amplifier, 85W..... **\$259.99**

80W UHF RF Power Amplifier

Take advantage of reliable, efficient, and wideband-capable performance with the PA-80U amplifier. It offers a nominal output of 80W with 3 to 5W input drive on any frequency from 430-470 MHz, along with signature Toptek features: front panel power and SWR metering; automatic fault for high SWR; mode switch for automatic SSB delay and peak power metering; RF sense keying; and more.



TEK-PA-80U UHF Power Amplifier, 80W..... **\$269.99**

HA8DU PRODUCTS



HA8DU Antenna Tuners

Well regarded by operators throughout Europe, HA8DU manual and automatic desktop antenna tuners deliver pure performance in a well-built unit inside and out. Features include switching for tuned or direct connection to multiple antenna ports, a bypass connector for an external dummy load, cross-needle power and SWR meters on manual models, a top-grade turns counter on manual roller tuners and heavy-gauge coated steel enclosures. These tuners deliver 1.8 MHz to 30 MHz coverage and smooth tuning that make them a long-lasting addition to any station.

Manual

HDU-DU1500T T-Type, 1,500W, 1.8-30 MHz..... **\$819.99**

Automatic

The DU4000AL offers advanced automation and display features that are truly unique for a 4kW HF antenna tuner, making this unit the modern-day station command center for automatic band, antenna, and memorized tuning selections. It comes with 1.8 to 30 MHz coverage; an intuitive-to-operate 5-color, 5" touch screen that provides control, status, and metering functionality for all station operations; and complete tuning memorization of four rear panel antenna ports as well as direct voltage control of an external 8-port antenna switch and stack match switching. The DU4000AL interfaces with all types of transceivers; an RS-232 interface can be used in-line between specific Yaesu, Kenwood, or Elecraft transceivers and the PC, or you can use the tuner's direct Icom "remote" CI-V input while connecting the transceiver to the PC by USB. Remote operation is available over the Internet via LAN-Ethernet, supported by a Windows application.



HDU-DU4000AL Automatic Antenna Tuner, 4kW, 1.8 to 30 MHz..... **\$4,749.99**

MFJ



MFJ-962D

Antenna Tuners

Here are some of MFJ's most popular HF antenna tuners, including several from its manual Versa Tuner and automatic IntelliTuner lines. Many IntelliTuners are designed to work with a specific transceiver; find the right one for your radio, along with plenty of specs on each at DXEngineering.com.

Part Number	Type	Power Handling	Price
MFJ-939I	IntelliTuner	200 W	\$199.95
MFJ-939K	IntelliTuner	200 W	\$199.95
MFJ-939Y	IntelliTuner	200 W	\$199.95
MFJ-993B	IntelliTuner	300 W	\$329.95
MFJ-994B	IntelliTuner	600 W	\$419.95
MFJ-949F	Versa Tuner II	300 W	\$279.95
MFJ-969	Versa Tuner II	300 W	\$319.95
MFJ-962E	Versa Tuner III	800 W	\$399.95
MFJ-989D	Versa Tuner V	1,500 W	\$539.95

COMET



CAT-300 Manual Antenna Tuner

Combining performance and visual appeal, the versatile CAT-300 from Comet covers 1.8 to 50 MHz and makes a fine addition for base station or portable operations. The compact unit handles up to 300 watts PEP SSB and features a precision cross meter; tuning of dipoles, vertical, mobile whip, long wire, and other types of antennas; simplified tuning with a "Band" inductor selector labeled by amateur frequencies; simultaneous measurement of forward power, reflected power, and SWR; illumination that allows easy viewing in low ambient light; push-button switches for selecting Average or PEP in 30- or 300-watt ranges; and switches for tuner bypass and two antenna ports. Enter "CAT-300" at DXEngineering.com for more details.

CMA-CAT-300 Manual Antenna Tuner..... **\$279.95**

Our catalog is only the beginning! See thousands of products at DXEngineering.com

LDG Z-100A-DXE Automatic Antenna Tuner and Interface Cables Package



DX Engineering and LDG Electronics have teamed up to exclusively offer the Z-100A Automatic Antenna Tuner bundled with seven 36" cables: six interface cables for use with many popular Alinco, Icom, Kenwood, and Yaesu transceivers, and one DC power cable compatible for use with Elecraft, FlexRadio, and other 100W rigs. Weighing only 1.5 lbs., the compact Z-100A (6.30" W x 1.50" H x 6.30" D) features LDG's famous 10:1 SWR tuning range that matches dipoles, verticals, end-fed wires, G5RVs, or even off-center-fed dipoles and Windom antennas. Covering 160 through 6 meters, the Z-100A delivers 125W PEP SSB and CW, and 30W Digital. The tuner works with all HF radios up to 125 watts RF output and can be interfaced with dozens of modern transceivers (an interface cable is not required for semi-automatic operation). Users benefit from its internal frequency counter and 2,000 memories to store each operating frequency with antenna tuning parameters. Memory retuning occurs in only 100 milliseconds, with the initial full tuning cycle requiring an average of only 6 seconds. Depending on the rig used, hams can execute quick automatic tuning either by pressing a button on the tuner or by pressing a button on the tuner or transceiver.

LDG-Z-100A-DXE Z-100A Tuner with 6 Interface Cables/1 DC Power Cable **\$199.99**

AT-600ProII Automatic Antenna Tuner

- Tunes 6 to 800 Ω loads
- 600 watts power handling maximum
- Bright LED display
- Requires 11 to 16 Vdc at 750mA
- 1.8 to 54 MHz frequency range
- Two-position switch with memories for each position
- 0.5 to 6 second tuning time, 0.1 second memory tune
- 4,000 memories for instant band switching



LDG-AT-600PROII..... **\$419.99**

Remote Antenna Tuner and Console Package

Just install one of these near your feedpoint, and you'll remedy a lot of power loss issues due to SWR in your feedline. The tuner is packed with 2,000 memories for instant band switching with sizzling fast speed and precision. It can tune 4 to 800 Ω loads and is well suited for dipoles, verticals, inverted-Vs, beams or any coax-fed antenna.



LDG-RC-100

LDG-RT-100

The 100 series handles up to 125 watts SSB/CW, and 30 watts digital. This combo package includes a remote control unit. The controller has an integrated DC power injector to supply the tuner, plus an on/off switch and tune button for comprehensive tuner control.

LDG-RT-RC-100 100 Watt Remote Tuner and Console **\$299.99**

Antenna Tuner Cables

The proper link between your tuner and radio is essential. LDG Electronics makes it easy to create the perfect match with these interface cables.

Part Number	Radio	Notes	Price
LDG-IC-PAC	Icom	For radios with AH-3/4 port, 14"	\$10.99
LDG-Y-ACC	Yaesu	For FT-100/857/891/897/991A	\$12.99
LDG-Y-ACC-2	Yaesu	For dx10, dx1200, 450, 950, others	\$12.99
LDG-Y-ACC-3	Yaesu	For dx101D, dx101MP, and dx3000	\$12.99
LDG-DC-PWR-CABLE	LDG	Replacement power cable, LDG devices	\$5.99

Z-11ProII Automatic Antenna Tuner

- 125 watts power handling maximum
- 1.8 to 54 MHz frequency range
- 0.1 to 6 second tuning time, 0.1 second memory tune
- 4,000 memories with automatic storage
- Tunes 6 to 100 Ω loads (16 to 150 Ω on 6M)
- Can operate using four AA batteries with user-installed holder
- Requires 6 to 16 Vdc at 300mA maximum, 25uA standby

LDG-Z-11PROII **\$219.99**



AT-1000ProII Automatic Antenna Tuner

- 1,000 watts power handling maximum
- 1.8 to 54 MHz frequency range
- 2,000 memories for each antenna and auto configuration storage
- Tunes 6 to 1,000 Ω loads (16 to 150 Ω on 6M)
- 10 second tuning time, 0.2 second memory tuning
- Bar graph LED display shows SWR and selectable power ranges

LDG-AT1000PROII **\$569.99**



AT-100ProII Automatic Antenna Tuner

- 125 watts power handling maximum
- 1.8 to 54 MHz frequency range
- Two-position switch
- 2,000 memories for each antenna and auto configuration storage
- Tunes 6 to 1,000 Ω loads (16 to 150 Ω on 6M)
- Matches virtually any coax-fed antenna
- Bar graph LED display shows power, SWR, mode and status
- Requires 11 to 16 Vdc at 500mA

LDG-AT-100PROII..... **\$279.99**



AT-200ProII Automatic Antenna Tuner

- 250 watts power handling maximum
- 1.8 to 54 MHz frequency range
- 2-position switch with 8 antenna memories
- 0.5 to 6 second tuning time
- Tunes 6 to 800 Ω loads (6 to 3,600 Ω with 4:1 balun)
- 4,000 memories for instantaneous band switching
- Easy-to-read LED display for RF power, SWR and status
- Requires 11 to 16 Vdc at 750mA

LDG-AT-200PROII..... **\$319.99**



Z-100Plus Automatic Antenna Tuner

- 125 watts power handling maximum
- 1.8 to 54 MHz frequency range
- 0.1 second memory tune
- 2,000 memories, sorted by frequency
- Tunes 6 to 800 Ω loads (16 to 150 Ω on 6M)
- SO-239 in/out connections for dipoles, verticals, beams, etc.
- Requires 7 to 18 Vdc at 100mA maximum

LDG-Z-100PLUS **\$199.99**



Automatic Antenna Tuner

- Tailored to the Yaesu FT-817 radio
- Excellent for QRP operation
- 20 watts power handling maximum
- 1.8 to 54 MHz frequency range
- 2,000 memories, sorted by frequency
- Tunes 6 to 600 Ω loads
- Powered by 4 AA batteries (not included)

LDG-Z-817 **\$149.99**

ACOM 04AT Remote Automatic Antenna Tuner

Powered and controlled by ACOM's solid state HF+6M amplifiers, this antenna tuner delivers automatic and manual tuning to ensure the proper impedance match between radio and amplifier. Full tuning is completely automatic, and tuning patterns can be stored in its nonvolatile memory (or transferred to a PC for future use). Tuner information is displayed on the amplifier's screen for easy use. It has built-in voltage, power, and hot-switching protection, and the unit can be mounted indoors or outdoors.

AOM-04AT Remote Automatic Antenna Tuner **\$1,499.99**



AH-730 Antenna Tuner

Icom's AH-730 antenna tuner lets you automatically tune a 23' or longer wire antenna with a suitable ground plane for portable or mobile HF/50 MHz use. The "PTT Tune" function provides for simple operation when band-changing and supports remote control from Icom transceivers. High-speed automatic tuning only takes 2-3 seconds, but when re-tuning to the same frequency, matching is achieved in as little as one second because of the AH-730's built-in 45 memory slots that store minimum SWR settings. Mounting kit, 32' control cable, and weatherproof cap included.

ICO-AH-730 Antenna Tuner **\$549.99**



ACOM 06AT Automatic Antenna Tuner

Made to work exclusively with Acom 600S, 700S, 1200S and 2020S solid-state amplifiers, the 06AT provides continuous coverage from 1.8-30 MHz and 50-54 MHz along with advanced amp/transceiver protection features and two operating modes: 100% automated Full Tuning or Fast Tuning that retrieves previous tuning results. The tuner employs a built-in four-port antenna switch that automatically matches the impedance of the operator-chosen antenna output by transforming it to 50 Ω with SWR below 1.5 at the tuner input (typically below 1.3), providing an optimum load impedance for the amplifier. Operators can select among several antenna profiles based on the bandwidth of the connected antenna (narrow, normal, broadband, etc.). Power and control functions come directly from a connected Acom amp. Fully automated operation requires a CAT, COM or CI-V frequency reading interface cable between the transceiver and amplifier. Enter "06AT" at DXEngineering.com for more details. See page 58 for convenient DX Engineering Remote Antenna Tuner Mounting Kits

AOM-06AT Automatic Antenna Tuner **\$1,599.99**



Genius Solutions Amplifier, Tuner, and Antenna Switch

DX Engineering now carries three performance-enhancing devices from FlexRadio's Genius Solutions' lineup. For pricing and more details, enter "Genius Solutions" at DXEngineering.com.



We stock many more items than we can show. See them all at DXEngineering.com!



Automatic Antenna Tuners

HF-AUTO 1,500 Watt Automatic Antenna Tuner

Palstar is taking the low-power autotuner to the next level with the HF-AUTO. This unit uses quiet, continuously variable components to create a perfect antenna match, without noisy relays. It can tune with a mere 2 watts of power, yet can handle 1,500 watts. The HF-AUTO covers 1.8 through 54 MHz, tunes within 6 seconds and has a large, backlit LCD with 4 lines of large print for easy readout of RF power, SWR, frequency, antenna port selection, position of inductor and capacitor, mode indication and setup information.

PAS-HF-AUTO 1,500 Watt Automatic Antenna Tuner **\$1,695.99**



AT2K 2,000 Watt Antenna Tuner

Building upon Palstar's impressive AT1500CV tuner, this AT2K 2,000 Watt Antenna Tuner features a new, smaller roller inductor, allowing the AT2K to tune from 160 meters to 6 meters. It can match dipoles, center fed doublets, verticals, end-fed wire, delta loops, beams, Windoms, inverted vees and many more antenna types.



The AT2K features three impedance matching controls for greater tuning range, 6-position antenna selector switch and Peak/Peak Hold metering in two ranges, 300 and 3,000 watts. Standing Wave Ratio measurements are displayed with this illuminated cross-needle meter. Its chassis is made of 11-gauge aluminum with a powdercoated finish on the front and top cover.

- Wide impedance range 20 to 1,500 Ω from 160 to 6 meters (assuming resistive load)
- Low minimum custom variable capacitors, 15pF to 400pF at 4.5 kV
- 26 uH 5 kV ceramic body roller inductor with turns counter
- Silver plated inductor wheel shaft and contact wheel

PAS-AT2K 2,000 Watt Antenna Tuner..... **\$795.99**

AT4K 2,500 Watt Antenna Tuner

The legendary AT4K 2,500 Watt Antenna Tuner built the Palstar reputation for high quality and durability. Updated for the 21st century, the AT4K now has a switchable, dual-movement active peak and peak hold wattmeter. The selection between unbalanced or balanced output is relay-switched with a front panel control on the AT4K.



The AT4K T-matching wide range network uses a 1:1 unbalanced-to-balanced transformer in the input of the network. When the network is properly tuned, an impedance of 50 Ω is presented to the input and output of the balun.

- T-match circuit with impedance matching range from 8 to 2,000 Ω
- Custom large value variable capacitors, 460pF at 6 kV
- 10 Amp silver plated ceramic body roller inductor handle-driven crank
- 11-gauge aluminum chassis, powdercoated on front and top

PAS-AT4K 2,500 Watt Antenna Tuner..... **\$1,394.99**

300, 600 and 1,500 Watt Remote Autotuners



These automatic tuners are mounted in durable, weather resistant hard-plastic cases for remote outdoor applications. They cover 1.8 to 30 MHz, use heavy-duty 16 amp/1,000 volt relays, and feature a highly efficient L-network. They also include the MFJ-4117 Bias-Tee Power Injector to send DC down your coax.



1,500 Watt Legal Limit Remote Autotuner

The MFJ-998RT IntelliTuner™ lets you rapidly tune almost any unbalanced or single-wire antenna automatically. Balanced feedlines may be used with an MFJ-912 1.5 kW 4:1 balun connected to the MFJ-998RT antenna output. MFJ's algorithms give you fast tuning with more than 20,000 non-volatile VirtualAntenna™ memories. You can save settings for several antennas, allowing you to move your tuner between antennas or to different locations without losing the old settings. Includes a switched-L network with wide matching capability, 1.8 to 30 MHz coverage, backlit LCD display and heavy-duty 16 amp/1,000-volt relays. It is rated at 1,500 watts SSB/CW and will match impedances from 12 to 1,600 Ω (SWR up to 32:1). MFJ-4117 Bias-Tee Power Injector included.

MFJ-998RT 1,500 Watt Legal Limit Remote Autotuner **\$949.95**

600 Watt Remote Autotuner

The MFJ-994BRT IntelliTuner™ is a 600 watt remote automatic antenna tuning unit similar in size to the MFJ-993BRT. At 600 watts, it's a perfect match for Ameritron's solid state ALS-600/S solid state amplifier and popular tube-type AL-811/H amplifiers. Eliminate extra feedline loss caused by SWR by tuning your antenna outdoors at its feedpoint. This tuner includes the MFJ-4117 Bias-Tee Power Injector. The MFJ-994BRT lets you quickly tune any 12-1,600 Ω antenna, balanced or unbalanced, automatically.

MFJ-994BRT 600 Watt Remote Autotuner..... **\$499.95**

300 Watt Remote Autotuner

The MFJ-993BRT IntelliTuner™ is a automatic antenna tuning unit mounted in a durable hard-plastic case. Measuring 9.25" W x 3" H x 14.25" D, it covers 1.8 to 30 MHz, has heavy-duty 16 amp/1,000-volt relays and is a highly efficient L-network. It also includes the MFJ-4117 Bias-Tee Power Injector. It's intended to be mounted outside at the feedpoint of your antenna, providing a 50 Ω match to your coaxial cable feedline and eliminating additional feedline loss caused by SWR. The MFJ-993BRT lets you quickly tune any 6-1,600 Ω antenna, balanced or unbalanced, automatically.

MFJ-993BRT 300 Watt Remote Autotuner..... **\$399.95**

See page 58 for convenient DX Engineering Remote Antenna Tuner Mounting Kits.

mAT-TUNER Antenna Tuners



A proud member of the venerable Vibroplex family of Amateur Radio products, mAT-TUNER from INRAD offers a line of antenna tuners recognized for their sturdy construction, ease of use and exceptional performance. These automatic tuners deliver the goods: machined, black oxidized aluminum cases; quality multi-level PC boards; control direct from transceiver front panel for Icom, Kenwood and Yaesu transceivers (some models); up to 200W power handling capabilities (see new MA-Y200 model for select Yaesu transceivers); models for QRP and outdoor operation; 5-1,500 Ω matching range; and 16,000 frequency memories (some models). Tuners come with a two-year parts/labor warranty. A reliable choice for tuning dipoles, verticals, Yagis, long-wire or virtually any other coax-fed antenna. Enter "MTU" at **DXEngineering.com** for more details and transceiver compatibility.



- | | | |
|--------------|--|-----------------|
| MTU-MAT-10 | QRP, for Yaesu FT-817/818, 1.8-54 MHz at up to 30W; Includes Two 10440 Li-Ion Batteries | \$229.95 |
| MTU-MAT-30 | For Yaesu, HF+6 at up to 120W..... | \$179.95 |
| MTU-MAT-40 | Outdoor Weatherproof Long-Wire and Vertical Wire Tuner, 1.8-54 MHz | \$259.95 |
| MTU-MAT-K100 | For Kenwood/Icom, 1.8-54 MHz at up to 120W | \$174.95 |
| MTU-MAT-125E | Most HF Transceivers, Requires Only 100 mW to Actuate; Includes Two 18650 Li-Ion Batteries | \$179.95 |
| MTU-MAT-180H | For Kenwood/Icom, 1.8-54 MHz at up to 120W, Allows Manual Fine Tuning | \$179.95 |

Automatic Antenna Tuner for Icom IC-705 All Mode Portable Transceiver

This lightweight and compact device adds simple and convenient tuning functions to the IC-705, with the ability to tune dipoles, verticals, Yagis or virtually any coax-fed antenna within the range of 1.8 MHz to 54 MHz. The unit boasts tuning times of 0.1 to 5 seconds full tune, 0.1 seconds memory tune; comes housed in a sturdy aluminum shell; has 16,000 frequency memories; and includes the MAT-705 control cable which connects to the TUNER socket of the radio and the CON socket of the tuner.

- | | | |
|-----------------|---|-----------------|
| MTU-MAT-705PLUS | Automatic Antenna Tuner for IC-705..... | \$229.95 |
| MTU-MAT-RC1 | Coaxial Cable Assembly for MAT-705PLUS..... | \$10.00 |

Automatic Antenna Tuner for Yaesu Transceivers

The MAT-Y200 Antenna Tuner (1.8 MHz-54 MHz, 200W PEP, 50W Digital) works with Yaesu transceivers that support FC-30, FC-40, FC-50 Yaesu external tuners. A partial list includes the FT-100D, FT-857/D, FT-897/D, FT-450/D, FT-891, FT-950, FT-991, FT-991-A, FTDX-1200, FTDX-3000, FTDX10, FTDX-101D, FTDX-101MP. The included interface cable connects the radio to the tuner, which provides band data and 12V DC power.



MTU-MAT-Y200 Automatic Antenna Tuner for Yaesu Transceivers..... **\$239.95**

Antenna Tuner Cables

- | | | |
|--------------|--|----------------|
| MTU-MAT-40-M | For Icom Transceivers..... | \$13.50 |
| MTU-MAT-40-K | For Kenwood Transceivers..... | \$13.50 |
| MTU-MAT-40-Y | For Yaesu Transceivers | \$13.50 |
| MTU-MAT-CI | For Use with MAT-K100 and MAT-180H (Icom)..... | \$19.00 |
| MTU-MAT-CK | For Use with MAT-K100 and MAT-180H (Kenwood) | \$19.00 |

YAESU

Automatic Antenna Tuners

Yaesu offers a pair of antenna tuners to complement its base and portable radios. These compact tuners cover 1.5-54 MHz and handle 100 watts. Switching bands is easy, thanks to the tuners' memory storage and laser-fast tuning.



- | | | |
|-----------|---|-----------------|
| YSU-FC-30 | Antenna Tuner for FT-857/897 | \$249.99 |
| YSU-FC-40 | Antenna Tuner for FTDX-1200/300 and FT-450/857..... | \$329.99 |



Check out our blog, OnAllBands.com, for articles on upcoming DXpeditions, what's new in contesting, digital operations, and a range of other topics.

Want more? We've got loads of tech videos and interviews on the DX Engineering YouTube channel. Of course, when you want personal attention, our experts are only an email or phone call away.

DXEngineering.com is loaded with detailed photos, specs, videos, and more!

DX ENGINEERING**DX Engineering Maxi-Core® 20 Baluns and Feedline Choke**

Get ready to make a significant upgrade to your station's performance with the next generation of baluns and feedline choke from the team at DX Engineering.

Years of R & D coupled with major advancements in test equipment and techniques combined with custom ferrite materials have allowed our engineers to design these devices, signaling a new era of RF performance across the 1.8 to 54 MHz frequency range. Maxi-Core 20 Baluns and Feedline Choke:

- Reduce or eliminate currents on the outside of your feedline, allowing you to hear and to be heard much better
- Perform at the highest levels of efficiency in transmit or receive applications
- Provide much higher common mode impedance (CMI) across a greater frequency range—AM Broadcast band and the HF/6M spectrum—compared to competing models and even previous DX Engineering and Comtek models (CMI is a measure of how well a balun or feedline choke reduces exterior RF currents traveling through it and on the outside of the coaxial cable)
- Keep more RFI/BCI out of your antenna and receiver
- Transfer more of your transmitted signal to the antenna for high efficiency, the best antenna pattern, and maximum performance
- Force currents on the feedline or antenna to be equal for maximum efficiency and more symmetrical antenna patterns
- Handle full-legal-power-plus
- Feature 1/4-20 stainless steel hardware, a high-quality silver-plated PTFE dielectric SO-239 (UHF female) input connector, 4 weepholes to eliminate internal moisture, and weather-resistant NEMA enclosure with convenient mounting holes

Hear and be heard with DX Engineering Maxi-Core 20 Baluns and Feedline Choke!**Choose from 5 options:**

DXE-MC20-1-1, 1:1 Current Choke Balun
For all HF-6M balanced antennas with a 50 Ω feedpoint, including resonant dipoles, loops, Yagis and beams.

DXE-MC20-FC, 1:1 Feedline Choke
Use this high CMI line isolator inline on 50 Ω feedlines, at the antenna, tower or shack end of the feedline.

DXE-MC20-1-1T, 1:1 Current Choke Balun
This 1:1 "T" model provides outdoor transition from any impedance balanced "ladder" line to coaxial cable and a wide impedance range tuner. Made for high-SWR non-resonant multiband antenna systems to force currents equal on the balanced line to minimize radiation and RFI, and maximize antenna performance.

DXE-MC20-C4-1, 4:1 Current Choke Balun
For use on antennas with a 200 Ω feedpoint and on any impedance ladder line, especially antenna systems with higher impedance. This model tolerates operation at high SWR on non-resonant multi-band antennas.

DXE-MC20-V4-1, 4:1 Voltage Balun
Use this 200 Ω to 50 Ω transformer on random long-wire and OCF antennas. This true voltage balun tolerates high SWR and is intentionally designed with low CMI for antennas that need a transformer without RF choking for easier tuner operation.

Enter "DXE Maxi" at DXEngineering.com for complete details.

DXE-MC20-1-1	Maxi-Core 20 High CMI 1:1 Current Choke Balun	\$169.99
DXE-MC20-FC	Maxi-Core 20 High CMI 1:1 Feedline Choke, Line Isolator	\$169.99
DXE-MC20-1-1T	Maxi-Core 20 High CMI 1:1 Current Choke Balun, Tuner Model	\$147.99
DXE-MC20-C4-1	Maxi-Core 20 High CMI 4:1 Current Choke Balun	\$169.99
DXE-MC20-V4-1	Maxi-Core 20 Low CMI 4:1 Voltage Balun	\$141.99

Cable Strain Relief Brackets

Mounting your balun or choke is only part of the equation—you still need to make sure your coaxial cables are secure and free from the stress of gravity. Our Cable Strain Relief Brackets will help prevent the cable from pulling from your PL-259 connector.

DXE-CSR8X-1	Cable Strain Relief Assembly, for RG-8X Cable	\$26.99
DXE-CSR213-1	Cable Strain Relief Assembly, for RG-213/U Cable	\$26.99



DXE-CSR213-1



DXE-MC20-V4-1



DXE-MC20-FC

DX ENGINEERING**Wire Antenna Balun Mounting Bracket Kit for Maxi-Core® 20 Baluns**

Mounting your balun correctly is critical to maintaining its reliability. Here's the right solution to make sure your balun is ready to face Mother Nature—the Wire Antenna Balun Mounting Bracket Kit. To ensure proper balun operation, DX Engineering created this mounting kit designed specifically for single-band wire antenna setups. At the heart of each kit is a nearly indestructible mounting bracket made from a UV-resistant poly-resin compound. You'll also get a pair of DX Engineering end insulators, along with all the stainless hardware required for installation. Its unique design provides minimum capacitive coupling between the antenna wire and the field surrounding the balun core. The DXE-WA-BMB is compatible with all Maxi-Core® 20 baluns and legacy Comtek baluns.

DXE-WA-BMB Wire Antenna Balun Mounting Bracket Kit\$29.99

**DX ENGINEERING****Balun or Feedline Choke Mounting Plate and Bracket Kit**

This kit provides a variety of mounting solutions for DX Engineering Maxi-Core 20, Comtek and other brands that use 4" x 4" x 2" plastic NEMA boxes. This rugged polymer plastic plate and stainless steel bracket kit may be used at the base of any vertical, on the boom of a Yagi or beam antenna, or even on a mast or post. This unique perpendicular mount provides a beneficial separation between the ferrite of the balun or choke and the metal tubing, resulting in improved choking performance. This UV black high-strength polymer mounting plate provides added isolation between the feedline and the antenna system for optimal performance and decoupling. The stainless steel mounting bracket is laser cut for optional heavy-duty DX Engineering V-Saddle Clamps.

DXE-MC20K-BRKT Mounting Plate and Bracket for Maxi-Core 20\$37.99

Choke and Mounting Packages

Also available are packages which include both a Maxi-Core 20 choke and mount. Choose from the 1:1 current choke balun and vertical/beam mount package for 50 Ω feedpoint antennas or the 1:1 feedline choke and inline mount combo for 50 Ω coaxial feedlines.

DXE-MC20-FCM 1:1 Feedline Choke and Inline Mount Package, 50 Ω\$207.98

DXE-MC20-1-1BM 1:1 Balun, Mount Package for Verticals/Beams, 50 Ω\$207.98

**DX ENGINEERING****Balun Upgrade Kits**

Ready to take your Yagi, beam or rotatable dipole to the next level? These kits provide everything you need to take advantage of improved station performance: 1:1 DX Engineering Maxi-Core® 20 Balun, mounting bracket, hardware and clamps for your antenna update. Maxi-Core® 20 Baluns handle full-legal-power-plus and provide higher common mode impedance across a greater frequency range than competing models. These baluns exhibit very low insertion loss and inherently low SWR. Kits include:

- DXE-MC20-1-1 Maxi-Core® 20 1:1 Current Choke Balun made for all HF-6M balanced antennas with a 50 Ω feedpoint, including resonant dipoles, loops, Yagis and beams
- DXE-BMB-4P Balun Mounting Bracket designed for Maxi-Core® 20 baluns, with poly-resin plate and stainless steel hardware
- DXE-BALUN-WK Balun Wiring Kit, which includes wire, terminal and hardware for antenna connection
- DXE-ECLS-150 or DXE-ECLS-200 Stainless Mounting Clamp with Studs for antennas with 1.50" booms or masts or up to 2" booms or masts

DXE-BN86-20UP150 Balun Upgrade Kit for 1.5" Boom or Mast\$222.96

DXE-BN86-20UP200 Balun Upgrade Kit for up to 2" Boom or Mast\$223.46

**DX ENGINEERING****4:1 High Power UNUN for Non-Resonant Vertical Antennas**

Using non-resonant multi-band antennas? This UNUN helps your antenna system operate at maximum efficiency by minimizing transmission line losses caused by SWR. You can add this UNUN to any 43 foot antenna system; it covers 1.8-30 MHz and can handle 2 kW CW/5 kW SSB.

A feedpoint connection kit is available separately.

DXE-UN-43 High Power 4:1 UNUN\$201.99

DXE-UN-BRKT-5A UNUN Mounting Kit\$18.99

DXE-TCB-UNFK UNUN to Vertical Feedpoint Connection Kit\$11.99



DX Engineering carries equipment from more than 160 top manufacturers!

DX ENGINEERING

High Impedance Common Mode RF Choke Kit

This 40-toroid, Mix-31 solid ferrite bead choke kit provides the simplest and most effective technique of creating RF isolation at an antenna feedpoint or feedline termination. Covering 1.8 to 54 MHz, these beads—installed on a user-supplied coaxial cable prior to connector installation—provide high common mode impedance resulting in received noise reduction, reduced RF on the shield, better antenna performance, elimination of phasing errors and erroneous meter readings, the best 1:1 balun, and other benefits for applications including Yagis, dipoles, verticals, and phased array element feedpoints. The DXE-FBC kit's 0.500" I.D. ferrite beads come with 48-inch long heat shrink tubing to secure them in place. Simply slide the beads over any standard 0.405" coaxial cable and use a heat gun or hair dryer to secure them for long-lasting weather protection.



New!

DXE-FBC Choke Kit, 40 Beads, 1.8-54 MHz\$152.99

DX ENGINEERING

Color-Coded Ferrite RF Noise Reduction Kits

There's nothing more frustrating than searching through a box of unmarked ferrite toroids and beads, unsure of which ones are right for your application. The problem: They all look the same, but they're made from different mixes of ferrite, a ceramic made from oxides of magnetic metals. DX Engineering has selected mixes designed to block and dissipate RF currents, a technique that is proven to suppress radio frequency interference (RFI). Each mix works best over a certain frequency range. By color-coding our ferrite products, you can tell a toroid made from 31-mix from one made with 77-mix at a glance, taking the guesswork out of finding the right piece to place on your feedlines. Parts are color-coded as follows:



- 31-Mix, Blue – 1 MHz to 300 MHz
 - 43-Mix, Silver – 25 MHz to 300 MHz
 - 52-Mix, Orange – 200 MHz to 1 GHz
 - 61-Mix, Red – 200 MHz to 2 GHz
 - 75-Mix, Green – 150 KHz to 30 MHz
 - 77-Mix, Pink – 100 KHz to 50 MHz
- DXE-ACDCGEN1-RFI For AC/DC Generator, Two 3" I.D. Toroids, Mix 31.....\$99.99
 DXE-ACDCGEN2-RFI For AC/DC Generator, Two 1" I.D. Snap-On, Mix 31\$52.99
 DXE-AM-RFI For AM Broadcast, 5 Toroids, 8 Snap-On, Mix 77\$109.99
 DXE-CSB31-10-1 One 1" I.D. Snap-On Bead, Mix 31.....\$34.99
 DXE-CSB31-275-10 Ten .275" I.D. Snap-On Beads, Mix 31.....\$34.99
 DXE-CSB31-525-5 Five 0.5" I.D. Snap-On Beads, Mix 31.....\$34.99
 DXE-CSB31-750-5 Five .75" I.D. Snap-On Beads, Mix 31.....\$36.99
 DXE-CSB31-COMBO 4 Small, 2 Med., 2 Large Snap-On Beads, Mix 31.....\$41.99
 DXE-CSB61-COMBO 20 Snap-On Bead Pack, Mix 61.....\$106.99
 DXE-CSB75-375 One .375" I.D. Snap-On Bead, Mix 75.....\$27.99
 DXE-CSB75-750-2 Two Large .75" I.D. Snap-On Beads, Mix 75.....\$48.99
 DXE-LA1-RFI For Linear Amplifier, 1 Toroid, 2 Snap-On, Mix 31.....\$68.99
 DXE-LA2-RFI For Linear Amplifier, 1 Toroid, 3 Snap-On, Mix 31.....\$83.99
 DXE-LA3-RFI For Linear Amplifier, 1 Toroid, 4 Snap-On, Mix 31.....\$72.99
 DXE-TC31-24-4 Four 1.4" I.D. Toroids, Mix 31.....\$62.99
 DXE-TC31-40-1 One 3" I.D. Toroid, Mix 31.....\$61.99
 DXE-TC43-14-10 Ten .90" I.D. Toroids, Mix 43.....\$51.99
 DXE-TC43-24-4 Four 1.4" I.D. Toroids, Mix 43.....\$63.99
 DXE-TC43-82-25 25 .52" I.D. Toroids, Mix 43.....\$61.99
 DXE-TC52-14-4 Four .9" I.D. Toroids, Mix 52.....\$43.99
 DXE-TC52-24-2 Two 1.4" I.D. Toroids, Mix 52.....\$44.99
 DXE-TC61-24-2 Two 1.4" I.D. Toroids, Mix 61.....\$60.99
 DXE-TC75-24-2 Two 1.4" I.D. Toroids, Mix 75.....\$47.49
 DXE-TC77-14-8 Eight .90" I.D. Toroids, Mix 77.....\$45.99
 DXE-TC77-24-2 Two 1.4" I.D. Toroids, Mix 77.....\$45.99
 DXE-TC77-82-20 20 .52" I.D. Toroids, Mix 77.....\$47.99
 DXE-TC-COMBO Ten 2.4" O.D. Toroids, Mixes 31/61/77.....\$116.99
 DXE-XCVR1-RFI For HF Base Station, 2 Toroids, 3 Snap-On, Mix 31.....\$49.99

LDG ELECTRONICS

UNUNS

The RU-1-1 1:1 UNUN helps remove unwanted RF from the coax cable shield. This 200W PEP common-mode RF choke is ideal for short coax cable runs or non-resonant antennas. The RU-1-1 features SO-239 sockets for both input and output. The RU-9-1 UNUN allows easy interface of vertical and end-fed antennas to the LDG line of automatic antenna tuners. This 200W PEP UNUN may also be used for many antenna projects where a 4:1 or 49:1 UNUN is needed.



LDG-RU-1-1 1:1 UNUN, Coax Choke\$29.99
 LDG-RU-9-1 9:1 UNUN, Interface for Vertical and End-Fed Antennas ...\$29.99

DX ENGINEERING

ISO-PLUS Ethernet RF Filter

Give yourself another tool to help you pull out those weak signals and operate more effectively. DX Engineering has designed a simple way to suppress electromagnetic interference (EMI) and reduce common-mode RF interference (RFI) to and from Ethernet cables used between your personal computers, printers, routers, cable modems, transceivers and other devices. This interference is a common problem on Gigabit Ethernet Cat5e and Cat6 cables used for network LAN connections. The patent pending ISO-PLUS is an inline Ethernet filter that joins two RJ-45 connectors together to fight common-mode RFI and EMI noise interference for radio frequencies from well below 1 MHz to over 100 MHz. Installed on either end of Ethernet cables, ISO-PLUS filters mitigate RFI caused to the Ethernet-connected device. At the same time they reduce interference to radio receivers and other Ethernet devices that is caused by RFI or EMI generated by an Ethernet-connected device. The ISO-PLUS provides common mode attenuation resulting in reduced or eliminated EMI or RFI caused by power supplies, wall power adapters, touch lamps, appliances, and just about anything else near RJ-45 cables. The RF filters do not affect Ethernet data signal levels or speed. Each ISO-PLUS comes with one shielded RJ-45 patch cable (about six inches). The filters work with Cat5, Cat5e, Cat6 and Cat6a cables with RJ-45 connectors. Available in sets of two or ten filters. The ISO-PLUS units do NOT pass DC voltages and do not support PoE (Power over Ethernet).



DXE-ISO-PLUS-2 Ethernet RF Filter, 2 Units\$81.99
 DXE-ISO-PLUS-10 Ethernet RF Filter, 10 Units\$355.99

Assembled 50 Ω Choke Balun

Choke baluns ensure that RF does not flow on the outside shield of feedlines, phasing lines, etc. This COMTEK balun consists of 75 heavy-duty mix-31 RF choke beads on a length of RG400 PTFE coax terminated with silver-plated PTFE PL-259/UHF male connectors. The balun comes assembled except for the provided correct length of heat-shrink tubing, which needs to be installed. The choke provides excellent common mode impedance and handles up to 5 kW from 1.8 to 54 MHz.



COM-CFC-50A 50 Ω Choke Balun, Assembled.\$131.49

Accessories

DXE-RADP-3 Stainless Steel Radial Plate with 20 Bolt Sets.....\$99.99
 DXE-SSVC-2P V-Saddle Clamp, Fits 1" to 2" Tube.....\$16.49

Iron Powder Cores

DX Engineering now carries popular material numbers and sizes of iron powder core toroids that can be used by amateur radio operators to build cost-effective RF inductors for MF to UHF circuit board applications, as well as for RF suppression. Their low permeability makes iron powder inductor cores preferred over ferrite in high-temperature environments inside hot equipment. Further, inductors wound on iron powder cores produce less electromagnetic interference to adjacent circuits. Choose from #2 (250 kHz-10 MHz) and #6 (3-40 MHz) toroids in packs of 5, 10, or 25. Enter "Powder Core" at DXEngineering.com for more details.



DXE-TPC02-05-25 Toroid, #2, 250 kHz-10 MHz, 0.5" O.D. Pack of 25.....\$30.99
 DXE-TPC02-157-10 Toroid, #2, 250 kHz-10 MHz, 1.57" O.D. Pack of 10.....\$49.99
 DXE-TPC02-225-5 Toroid, #2, 250 kHz-10 MHz, 2.25" O.D. Pack of 5.....\$70.99
 DXE-TPC06-03-25 Toroid, #6, 3-40 MHz, .307" O.D. Pack of 25.....\$25.99
 DXE-TPC06-05-25 Toroid, #6, 3-40 MHz, 0.5" O.D. Pack of 25.....\$29.99



CHA-UNUN-BALUN-1 CHA-UNUN-BALUN-4 CHA-UNUN-BALUN-6 CHA-UNUN-BALUN-9

Baluns and UNUNs

Built to benefit a range of antenna systems, Chameleon Baluns and UNUNs are designed to enhance impedance transformation and signal efficiency while minimizing interference. Each unit features an FT-240-43 toroidal core precisely wound with PTFE-insulated, 14 AWG enameled copper wire; durable weatherproof housing; and top-mounted stainless steel eyebolt that provides a secure anchor point for base or portable operation. Check individual devices for antenna compatibility.



New!

CHA-UNUN-BALUN-1 1:1 Current Balun, 1-100 MHz, 50 Ω Input, 1,000W PEP.....\$114.99
 CHA-UNUN-BALUN-4 4:1 UNUN, 1-52 MHz, 200 Ω Input, 1,000W PEP\$114.99
 CHA-UNUN-BALUN-6 6:1 UNUN, 1.5-70 MHz, 300 Ω Input, 1,500W PEP\$114.99
 CHA-UNUN-BALUN-9 9:1 UNUN, 1.5-30 MHz, 450 Ω Input, 1,200W PEP\$114.99

Check out our YouTube channel for in-depth tech tips and product demos!

Antenna Support and Guy Line Ropes



Specifically designed for guying and support, Mastrant ropes come in several sizes and strength ratings. They're perfect for wire antennas, supporting Yagi booms and elements, as well as guying verticals and antenna masts. These non-conductive ropes are made from synthetic fibers that won't collect moisture or suffer from UV degradation.

All rope comes in a 328 foot/100 meter roll, and popular selections are available in 100 foot/30 meter and 1,650 foot/500 meter rolls (not listed in table; enter "MSG 1650" at DXEngineering.com). Choose from standard Mastrant-P or stronger M. R (yellow) and O (orange) are bright reflective versions of P. High-strength Q ropes have a polyester/polypropylene core. Enter "MSG" at DXEngineering.com for more options.

Part Number	Type	Diameter	Length	Strength	Price
MSG-MQ05031	Mastrant-O	5.8mm/.228"	100' (31M)	540 Lbs.	\$34.99
MSG-MP02100	Mastrant-P	2mm/.079"	330' (100M)	220 Lbs.	\$22.99
MSG-MP02200	Mastrant-P	1.6 mm/.063"	660' (200M)	220 Lbs.	\$45.99
MSG-MP03031	Mastrant-P	3mm/.118"	100' (31M)	440 Lbs.	\$12.99
MSG-MP03100	Mastrant-P	3mm/.118"	330' (100M)	440 Lbs.	\$31.99
MSG-MP03200	Mastrant-P	2.6mm/.102"	660' (200M)	440 Lbs.	\$63.99
MSG-MPA3031	Mastrant-P	3.5 mm/0.141"	100' (31M)	300 Lbs.	\$16.99
MSG-MPA3100	Mastrant-P	3.5 mm/0.141"	330' (100M)	300 Lbs.	\$43.99
MSG-MP04031	Mastrant-P	4mm/.158"	100' (31M)	882 Lbs.	\$19.99
MSG-MP04100	Mastrant-P	4mm/.158"	330' (100M)	882 Lbs.	\$50.99
MSG-MP04200	Mastrant-P	4.4mm/.173"	660' (200M)	970 Lbs.	\$101.99
MSG-MP05100	Mastrant-P	5mm/.197"	330' (100M)	1,102 Lbs.	\$72.99
MSG-MP05100	Mastrant-P	4.9mm/.193"	660' (200M)	1,190 Lbs.	\$72.99
MSG-MQ06100	Mastrant-Q	6mm/.236"	330' (100M)	730 Lbs.	\$106.99
MSG-MQ08100	Mastrant-Q	8mm/.315"	330' (100M)	1,700 Lbs.	\$144.99
MSG-MQ11100	Mastrant-Q	11mm/.394"	330' (100M)	2,780 Lbs.	\$198.99
MSG-MM02031	Mastrant-M	2mm/.079"	100' (31M)	529 Lbs.	\$18.99
MSG-MM02100	Mastrant-M	2mm/.079"	330' (100M)	529 Lbs.	\$50.99
MSG-MM03031	Mastrant-M	3mm/.118"	100' (31M)	860 Lbs.	\$30.99
MSG-MM03100	Mastrant-M	3mm/.118"	330' (100M)	860 Lbs.	\$82.99
MSG-MM04100	Mastrant-M	4mm/.158"	330' (100M)	1,984 Lbs.	\$166.99
MSG-MM05100	Mastrant-M	5mm/.197"	330' (100M)	2,535 Lbs.	\$263.99
MSG-MR02100	Mastrant-R	1.6mm/.063"	330' (100M)	220 Lbs.	\$24.99

Antenna Support Rope

Synthetic Textile Industries' double-braided Dacron/Polyester ropes are not weakened by decay or mildew, and provide excellent resistance to abrasion. The color-sealed, black polyester yarn used in the braided jacket also protects the cord from degradation caused by ultraviolet light. It is available in a variety of diameters and lengths.

Part Number	Diameter	Break Strength	Length	Price
SYN-DBR-94-100	3/32"	260 Lbs.	100'	\$12.99
SYN-DBR-94-1000	3/32"	260 Lbs.	1,000'	\$74.99
SYN-DBR-125-100	1/8"	420 Lbs.	100'	\$17.59
SYN-DBR-125-1000	1/8"	420 Lbs.	1,000'	\$109.99
SYN-DBR-187-100	3/16"	770 Lbs.	100'	\$21.99
SYN-DBR-187-350	3/16"	770 Lbs.	350'	\$57.99
SYN-DBR-187-500	3/16"	770 Lbs.	500'	\$80.99
SYN-DBR-187-1000	3/16"	770 Lbs.	1,000'	\$142.99
SYN-DBR-312-100	5/16"	1,790 Lbs.	100'	\$29.99
SYN-DBR-312-500	5/16"	1,790 Lbs.	500'	\$126.99
SYN-DBR-437-500	7/16"	2,150 Lbs.	500'	\$256.99



DX ENGINEERING

Ladder-Line Fed Dipole Antennas

The DX Engineering multi-band dipoles are rugged yet lightweight. Each model resonates at the low end of the band specified. They are usable to 30 MHz with a wide range tuner and come complete with the wire elements, ladder feedline, center-T support and end insulators.

- Elements: 14 AWG copper, PVC jacket for flexibility and strength
- Feedline: 100 feet, 18 AWG, 300 Ω ladder line, UV-resistant, 0.88 VF
- Hardware: stainless steel
- Center-T support and end insulators: High impact, UV-resistant material, black
- Power Rating: 1,500 W

DXE-WA-260	Antenna, 260' Long for 160M and Up	\$125.99
DXE-WA-135	Antenna, 135' Long for 80M and Up	\$93.99
DXE-WA-070	Antenna, 70' Long for 40M and Up	\$78.99

DX ENGINEERING

Glass Antenna Insulators

Operators have relied on glass insulators since the dawn of radio because they're a proven and effective way to improve the efficiency of your wire antenna—regardless of its configuration. DX Engineering's new Glass Antenna Insulators have an antique look, yet handle a significant amount of stress without breaking, making them well-suited to most wire antenna and support rope applications.



DXE-TGI-2	Glass Antenna Insulators, Pair	\$15.99
-----------	--------------------------------	---------



Mastrant Guying Hardware Packs

Properly guying your antenna is critical. That's why DX Engineering has worked with Mastrant's recommendations to assemble hardware packs with perfectly-matched components. These kits are tailor-made to work with Mastrant's guying rope, so you can build a safe, reliable guying system for your wire or vertical antenna.



Part Number	Kit Type	Rope Size	Kit Contents	Price 2 Pack
DXE-MSG2M-C1	Coupling	2mm	Shackles, Thimbles, Duplex Clips	\$13.99
DXE-MSG2M-C2	Coupling	2mm	Carabiners, Thimbles, Duplex Clips	\$12.49
DXE-MSG2M-C3	Coupling	2mm	Quick Links, Thimbles, Duplex Clips	\$13.49
DXE-MSG3M-C1	Coupling	3mm	Shackles, Thimbles, Duplex Clips	\$14.49
DXE-MSG3M-C2	Coupling	3mm	Carabiners, Thimbles, Duplex Clips	\$15.99
DXE-MSG3M-C3	Coupling	3mm	Quick Links, Thimbles, Duplex Clips	\$17.99
DXE-MSG1-3M-T1	Tensioning	1-3mm	Quick Links and Tensioners	\$11.99
DXE-MSG4-9M-SPL	Pulleys	4-9mm	2 Pack of Stainless Steel Pulleys	\$29.49
DXE-MSG2M-BD	Bull Dog Grips	2mm	Bull Dog Grips	\$11.99
DXE-MSG3M-BD	Bull Dog Grips	3mm	Bull Dog Grips	\$14.49
DXE-MSG2-5M-PL	Pulleys	2-5mm	Galvanized Steel Pulleys	\$16.49

More hardware packs available at DXEngineering.com

DX ENGINEERING

300 and 450 Ω Ladder Line

DX Engineering's 300 and 450 Ω Ladder Line is rated for full legal transmit power. The 300 Ω ladder line is constructed of 18-gauge conductors with 19 strands of copper clad steel wire, resulting in a velocity factor of 0.88. It is ideal for use with multi-band dipoles or other multi-band antennas.

The 450 Ω ladder line is constructed of 16-gauge conductors with 19 strands of copper clad steel wire. It is ideal for use with our Reversible Beverage Antenna system, DXE-RBS-1P. The wire makes the line strong enough for long horizontal runs between supports. Actual impedance is a nominal 400 Ω with a nominal velocity factor of 91%.

DXE-LL300	300 Ω Ladder Line	per foot	\$0.77
DXE-LL300-5C	300 Ω Ladder Line, 500' Spool		\$281.99
DXE-LL450-5C	450 Ω Ladder Line, 500' Spool		\$385.99
DXE-LL450	450 Ω Ladder Line	per foot	\$1.18
DXE-LL450-1K	450 Ω Ladder Line, 1,000' Spool		\$792.99
DXE-LL-INS	Ladder Line Supports for 450 Ω line, 25 Per Pack		\$22.49
DXE-LLC-1P	Ladder Line Coupler for 450 and 300 Ω Ladder Line		\$11.99



Center Insulator for Multi-Band Doublets with SO-239

This weatherproof, lightweight, high strength center insulator is used for connecting coaxial feedline to a doublet-type antenna. The insulator can be hung from a supporting mast. It has an SO-239 connector to attach to coaxial cable with a matching PL-259 connector.



HGN-C-1C	Center Insulator for Multi-Band Doublets	\$59.95
----------	--	---------

For new hams, check out our Getting Started HT, Mobile, and Base Radio Packages!

DX ENGINEERING

Single-Band Wire Antenna Dipole Kits

Choose from five models of rugged yet lightweight antennas that give you all the proven, reliable performance dipoles are known for plus the benefits of being constructed from high-quality DX Engineering components. Kits come with the DXE-MC20-1-1 Maxi-Core® 1:1 Balun; two 14 AWG stranded copper wires with black, relaxed PVC jacket and crimped and soldered 1/4" ring terminal on one end of each wire; high-strength wire antenna balun mounting bracket; end insulators; and stainless steel hardware. Antennas have up to a legal limit power rating of 1.5 kW when used with supplied balun. Also available are wire sets with ring terminals and hardware. **Enter "RDPK" at DXEngineering.com for more details.**



DXE-RDPK-160	Dipole Kit for 160M, Two 132' Wires.....	\$252.96
DXE-RDPK-8075	Dipole Kit for 80M or 75M, Two 69' Wires.....	\$242.46
DXE-RDPK-6040	Dipole Kit for 60M or 40M, Two 46' Wires.....	\$235.46
DXE-RDPK-30-17	Dipole Kit for 30M, 20M, or 17M, Two 26' Wires.....	\$228.96
DXE-RDPK-15-6	Dipole Kit for 15M, 12M, 10M, or 6M, Two 13' Wires.....	\$227.46
DXE-ANTW-132RT	Two 14 AWG 132' Wires w/Terminals, Hardware.....	\$45.49
DXE-ANTW-69RT	Two 14 AWG 69' Wires w/Terminals, Hardware.....	\$34.99
DXE-ANTW-46RT	Two 14 AWG 46' Wires w/Terminals, Hardware.....	\$27.99
DXE-ANTW-26RT	Two 14 AWG 26' Wires w/Terminals, Hardware.....	\$21.49
DXE-ANTW-13RT	Two 14 AWG 13' Wires w/Terminals, Hardware.....	\$19.99

DX ENGINEERING

Universal Wire Antenna Kits

Our Universal Wire Antenna (UWA) Kits contain parts to build several antenna types, like single band, multi-band, multi-frequency and folded dipole, doublet and inverted-V, Windom, off-center fed, Zepp, long wires, rhombic, vee beam and loop antennas.



The kits feature the new EZ-BUILD™ Center-T insulator and end insulators. The insulators' patented design features a serpentine wire grip for insulated DX Engineering Antenna Wire and DX Engineering's high strength, high-power 300 Ω ladder line. The serpentine wire connection grip is strong enough to support the antenna wires without looping or wrapping the wire ends. This allows fast and easy field antenna length adjustments without soldering.

The insulators are made of a lightweight, high strength, UV-protected material. The center-T insulator is designed to serve as a feedpoint and strain relief for antennas made with either wire or ladder line, which may be fed with either ladder line or coaxial cable. The center-T insulator can be the main support point for the antenna feedpoint by using the top center hole to attach a support rope. **DXE-UWA-KIT also serves as the mounting and support point for any DX Engineering Balun.**

The DXE-UWA8X-KIT and DXE-UWA213-KIT kits include a new strain relief bracket and P-clamps with neoprene cushions that grip the coaxial cable without deforming it, taking the weight of the hanging cable off of the connector. Each kit also includes crimp-on ring terminals for ladder line and antenna wire, and connection hardware.

DXE-UWA-KIT	Universal Wire Antenna Kit	\$30.49
DXE-UWA8X-KIT	Universal Wire Antenna Kit for RG-8X	\$83.99
DXE-UWA213-KIT	Universal Wire Antenna Kit for RG-213.....	\$85.99
DXE-UWA-END-KIT	End Insulators, Package of 8.....	\$13.99

Feedpoint Connectors

These connectors provide a direct transition from cable to feedpoint for a variety of antennas that do not have a coaxial connector. They feature two 4" or 11" silver-soldered solid tinned-copper 12 AWG wire leads which are epoxy potted into a plastic housing for a weather-sealed connection.



DXE-FFPC-SO239	SO-239, 4" Leads, Flanged	\$46.99
DXE-FFPC-SO239ZD	SO-239, 11" Leads, Flanged	\$55.99
DXE-FPC-716DIN	7-16 DIN Female, 4" Leads.....	\$86.99
DXE-FFPC-N	N Female, 4" Leads, Flanged.....	\$53.99
DXE-FFPM	Feedpoint Connector Mounting Bracket Kit.....	\$14.49

DX ENGINEERING

Premium Copper #14 Insulated Antenna Wire and Radial Wire

Use DX Engineering #14 Insulated Antenna Wire to achieve top performance while enjoying longer service life and trouble-free operation. This insulated copper wire is UV-resistant and lays out easily, unlike the wire that is commonly available at the "big box" stores which coils and kinks. It will last much longer in contact with the environment than bare wire. It is available in pre-cut lengths for easy dipole assembly or in bulk lengths of 500 and 1,000 feet for installing as many radials as possible with a ground-mounted vertical antenna.



DXE-ANTW-75	40M & Up, 75'	\$22.49
DXE-ANTW-150	80M & Up, 150'	\$49.99
DXE-ANTW-300	160M & Up, 300'	\$94.99
DXE-RADW-500	Premium Radial Wire, 500'.....	\$110.99
DXE-RADW-1000	Premium Radial Wire, 1,000'.....	\$207.99

Copperweld® 18 AWG Wire

When you need a high-strength and durable wire for your antenna projects, 18 AWG Copperweld® provides a corrosion-resistant solution that stays stronger longer and provides excellent conductivity thanks to its thick copper skin. A good choice for HF applications, these copper-clad solid steel wires won't stretch as much as other wires, which can affect resonant frequency. Plus, they can better handle heat, humidity and whatever else Mother Nature throws their way. Available in spools from 100 to 1,000 feet.



DXE-ANTCW18-100	18 AWG Copperweld® Wire, 100' Spool	\$12.99
DXE-ANTCW18-250	18 AWG Copperweld® Wire, 250' Spool	\$32.99
DXE-ANTCW18-500	18 AWG Copperweld® Wire, 500' Spool	\$71.99
DXE-ANTCW18-1000	18 AWG Copperweld® Wire, 1,000' Spool.....	\$121.99

High Visibility Antenna Wire

Most of the time, Hams don't want to call too much attention to their antennas, especially if their HOA is watching. But for those instances when you want your installations to stand out for safety reasons, such as on Field Day, DX Engineering has a solution—High Visibility Antenna Wire available in 150, 250 and 500 foot spools. Made from premium stranded copper 14 AWG, these PVC-insulated, "Hi-Viz" wires come in bright fluorescent green, pink and yellow to alert curious onlookers, help Hams work more efficiently in the field on their antenna projects, and serve as a warning in areas where children may be nearby. The relaxed, PVC insulation rolls out easily, unlike coated electrical wire which coils and kinks.

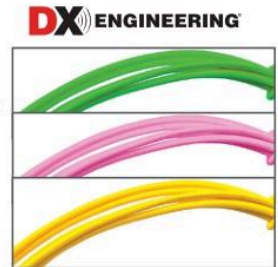

DXE-VIZ14-Y150	14 AWG Stranded Copper Wire, 150', Yellow	\$33.99
DXE-VIZ14-P150	14 AWG Stranded Copper Wire, 150', Pink	\$33.99
DXE-VIZ14-G150	14 AWG Stranded Copper Wire, 150', Green	\$33.99
DXE-VIZ14-Y250	14 AWG Stranded Copper Wire, 250', Yellow	\$44.99
DXE-VIZ14-P250	14 AWG Stranded Copper Wire, 250', Pink	\$44.99
DXE-VIZ14-G250	14 AWG Stranded Copper Wire, 250', Green	\$44.99
DXE-VIZ14-Y500	14 AWG Stranded Copper Wire, 500', Yellow	\$92.99
DXE-VIZ14-P500	14 AWG Stranded Copper Wire, 500', Pink	\$92.99
DXE-VIZ14-G500	14 AWG Stranded Copper Wire, 500', Green	\$92.99



High Visibility Antenna Wire

Consolidated Wire makes it easy to let others know to stay clear of your portable antenna installations with its 24 AWG High Visibility Antenna Wire. Made from tinned stranded copper, this wire is easy to use but hard to miss covered in orange, pink, or yellow PVC insulation. Available in spools of 100' (\$8.50), 200' (\$16.00), or 500' (\$39.00). **Enter "CEW Visibility" at DXEngineering.com for more details.**



Stealth Antenna Wire

DX ENGINEERING

For Hams fighting less than hospitable HOAs and installation restrictions, DX Engineering Stealth Antenna wire is the ticket. The thinness of the copper-coated, 7-strand 26 AWG steel wire makes it difficult to see, yet it's surprisingly strong, with a break load of 24.5 pound-force. Plus, the Stealth Antenna Wire is jacketed in rugged black UV-resistant polyethylene for added stability. Weighing only an ounce per 62 feet, it's also ideal for portable antenna installations and a good choice for constructing center-supported HF stealth dipoles, inverted vees or modest length end-fed wire antennas. Available in spools of 150, 250 and 500 feet.



DXE-SANTW-150	26 AWG Stealth Antenna Wire, 150' Spool	\$25.99
DXE-SANTW-250	26 AWG Stealth Antenna Wire, 250' Spool	\$41.99
DXE-SANTW-500	26 AWG Stealth Antenna Wire, 500' Spool	\$72.99

DXEngineering.com is loaded with detailed photos, specs, videos, and more!

BUCKMASTER INTERNATIONAL, LLC

Multi-Band Off-Center Fed Dipole HF Antennas

Buckmaster OCF Multi-Band HF Antennas offer exceptional performance with anvil-like reliability. The efficient off-center fed dipole design, and high-quality components, deliver years of trouble-free operating.

The permanently sealed center insulator houses either a 300 or 3,000 watt potted balun, secured by a 1/4 inch stainless steel eyebolt. Each antenna is fully assembled. DX Engineering carries the support rope and coaxial cable you need to complete your installation.



BMT-DX-OCF

Part Number	Bands	Wire Length	Power Rating (watts)	Price
BMT-DX-OCF-40	40, 20, 10 & 6 Meters	68'	300	\$274.00
BMT-DX-OCF	75/80, 40, 20, 17, 12, 10 & 6 Meters	135'	300	\$303.00
BMT-DX-OCF-160	160, 75/80, 40, 20, 17, 12, 10 & 6 Meters	270'	300	\$377.00
BMT-DX-OCF-HP40	40, 20, 10 & 6 Meters	68'	3,000	\$374.00
BMT-DX-OCF-HP	75/80, 40, 20, 17, 12, 10 & 6 Meters	135'	3,000	\$394.00
BMT-DX-OCF-HP160	160, 75/80, 40, 20, 17, 12, 10 & 6 Meters	270'	3,000	\$469.00

Multi-Band Wire Antennas

Since they use multiple parallel wires arranged in a fan-style design, EAntenna calls these antennas "multi-fan" dipoles.

The antennas' unique design allows each band dipole to remain separate from the others, which means you can pack multiple wire antennas in the space typically required for one. Each antenna listed below handles full legal limit power.



EAN-R2010049

Part Number	Bands	Wire Length	Price
EAN-R2010050	20, 15, 10M	34.42'	\$285.99
EAN-R2010049	80, 40M	88.51'	\$265.99
EAN-R2010048	80, 40, 20, 15, 10M	88.51'	\$179.99
EAN-R2010047	30, 17, 12, 6M	43.30'	\$289.99
EAN-R2010046	40, 20, 15, 10M	42.31'	\$345.99

G5RV All-Band HF Antenna



MFJ-1778



The world-famous G5RV antenna is a multi-band center-fed dipole with a 1,500 watt capacity. Designed as a 3/2-wavelength antenna for 14 MHz, it provides reasonable performance on many other bands. The antenna covers all bands from 160 to 10 meters when used with an antenna tuner. At 102 feet long, the G5RV is shorter than an 80 meter dipole. At 52 feet long, the MFJ-1778 Junior G5RV Antenna is half the size of the MFJ-1778 yet still covers 40 through 10 meters with tuner. It also handles 1,500 watts.

MFJ-1778	G5RV All-Band HF Antenna	\$89.95
MFJ-1778M	G5RV Junior Antenna	\$79.95

OCFD 40/20/10/6 Meter Dipoles

CAD designed and engineered for low SWR, high efficiency, wide bandwidth and frequency agility on all four of Amateur Radio's most interesting DX bands. Cut to length and preassembled; just connect your feedline. They're lightweight and easy to install.

MFJ-2010	OCFD UltraLite Dipole, 300 Watts	\$89.95
MFJ-2012	OCFD PowerLite Dipole, 1.5 kW	\$109.95

Dipole Antennas

Choose a Dipole Antenna from MFJ, and get effective yet reliable coverage in an antenna that's easy to use. Check out MFJ's lineup and select the dipole antenna that best suits your needs, and you can always visit DXEngineering.com for more specs.

Part Number	Band(s)	Tuner Required?	Notes	Wire Length	Price
Multi-Band Dipoles					
MFJ-1779B	80/40M	No	Trim to Length	142'	\$79.95
MFJ-2014	75/40M	No	Power-Lite	122'	\$139.95
MFJ-17754	40/20M	No	Dual-Band	42'	\$89.95
MFJ-1779C	20-6M	No	Trim to Length	35'	\$59.95
Portable Dipole with Telescopic Whips					
MFJ-2299	20-6M	No	FM Broadcast	34' Max.	\$179.95

ALPHA DELTA COMMUNICATIONS, INC.

Multi-Band Dipole Wire Antennas

Alpha Delta's complete resonant antennas include a DELTA-C center insulator and end insulators, ISO-RES coils and separate wires for different bands. All wires are attached to the center insulator. An SEP ARC-PLUG™ static electricity protector is built in. Stainless steel hardware and 12-gauge solid copper wire ensure long life. Antennas are shipped fully assembled. No antenna tuners are necessary, except for 15 meter band with DX-CC.



ALF-DX-LB

ALF-DX-CC	80-10 Meter Parallel Dipole, 82'	\$209.99
ALF-DX-DD	80-40 Meter Single Dipole, 82'	\$179.99
ALF-DX-EE	40-10 Meter Parallel Dipole, 40'	\$195.99
ALF-DX-LB	160-80-40 Meter Single Wire Dipole, 100'	\$209.99
ALF-DX-LBPLUS	160-10 Meter Parallel Dipole, 100'	\$245.99

ALPHA DELTA COMMUNICATIONS, INC.

Single Band Full Size Dipole Antennas

To get on the 80, 40 and 20 meter bands quickly, look to these antennas from Alpha Delta. They're pre-tuned for the lowest indicated frequency, but you can trim them to tune for any frequency from 14-30 MHz. They come fully assembled and include a Delta-C center insulator with built-in SEP ARC-PLUG™ static electricity protector, high strength copper wire and stainless steel hardware. They will easily handle full legal power.



ALF-DX-80

ALF-DX-80	Single Band Full Size Dipole, 80M, 134'	\$119.99
ALF-DX-40	Single Band Full Size Dipole, 40M, 67'	\$99.99
ALF-DX-20	Single Band Full Size Dipole, 20M, 34'	\$90.99

ALF-DELTA-C



ALF-SEP



ALF-DELTA-CIN



Antenna Insulator Kit with Static Discharge

This kit contains one center insulator, antenna connection hardware, one ARC-PLUG static electricity protector and two end insulators. The antenna hardware is molded of Deltalloy™, an extremely tough and durable plastic specifically blended to withstand sunlight and extreme weather conditions. An SO-239 connector is provided for direct connection to your coaxial cable. A ladder line balanced feedline may be connected directly to the dipole wire ends.

ALF-DELTA-C	Antenna Insulator Kit	\$42.99
ALF-DELTA-CIN	Replacement End Insulator	\$4.99
ALF-SEP	Replacement ARC-PLUG Protector	\$19.99

Bushcomm HF Antenna Systems

Horizon Multi-Band Wire Antennas

Designed for simple, efficient operation on multiple HF bands, these antennas use a relatively short length of wire to allow for a compact installation. Though these deliver good bandwidth right out of the box, Bushcomm recommends the use of a separate tuner to achieve maximum performance. Stainless steel wire is used for corrosion resistance. These antennas handle 200 watts on SSB. For the Center-Fed model, you can support either end for a traditional layout, but it works well in an inverted-V setup too.



Part Number	Bands	Length	Bandwidth at 40M	Design	Price
BCM-HORIZON-2040	20, 40M	43'	150 kHz	Center-Fed	\$165.99
BCM-HORIZON-3B	10, 20, 40M	40'	100 kHz	End-Fed	\$209.99

SWE Series Broadband End-Fed Antennas

Very similar to SWC Series Dipoles, Bushcomm's Broadband End-Fed Antennas are available either as a base station antenna, or bundled with a quick deployment kit suitable for portable and EMCOMM operation. The deployment kits include a grounding clamp, RG58 coaxial cable, ground stake, nylon cord, throw weight, and snap hooks.

Bushcomm HF Antenna Systems



Each 89 foot (79' wire, 10' ground) antenna covers 80-10M and, depending on the radio, doesn't require a tuner. The antennas come with a balun. SWE-100P also includes a handy winder tool that makes antenna deployment and storage easy.

Part Number	Antenna Wire Type	Deployment Kit	Price
BCM-SWE-100	7-Strand	Antenna Only	\$369.99
BCM-SWE-100P	49-Strand "Soft Stainless"	Yes, with Winder	\$479.99

Most in-stock parts ship throughout the contiguous US in just 1-2 days!



Multiband Off Center Fed (OCF) Dipole Antenna Kit

This Off Center Fed (OCF) wire dipole kit offers the benefit of HF multiband operation—an unusually useful result of feeding two different lengths of wire with a 4:1 balun—as compared to a single-band resonant dipole with equal length wire legs. Low SWR band coverage is typically achieved with a transceiver's internal antenna tuner (ATU). For legal limit 1.5kW SSB and CW power handling, the cost of OCF multiband operation is the requirement of a capable external tuner. This rugged wire antenna kit includes two lengths of premium 14 gauge relaxed PVC antenna wire with soldered ring terminal for connection to the balun; one DXE-MC20-C4-1 Maxi-Core® 4:1 Balun; the patented high-strength antenna center insulator DXE-WA-BMB Balun Mounting Bracket and End Insulators, stainless steel hardware, and printed instructions. User trims the provided 48' and 113' lengths of wire to achieve the desired band coverage (80-10M or 40-10M). Add rope and supports, such as a DX Engineering Carbon Fiber Mast, all available at DXEngineering.com.

DXE-OCF-KIT Multiband Off Center Fed Dipole Antenna Kit\$251.46

Kelemen Antennas

Kelemen Wire Antennas

DX Engineering is excited to be the exclusive North American retailer of high-performance, finely constructed Kelemen Wire Antennas from WiMo. Choose from 50 models of high-efficiency, wide-bandwidth monoband or multi-band antennas in many unique combinations of supported HF bands (160 through 10M), lengths, and power ratings (400W, 1,000W, or 2,000W PEP SSB and CW at resonance). These lightweight antennas come pre-assembled and ready to operate, with balun enclosed in a weatherproof polycarbonate case, clear PVC-insulated stranded copper wire, stainless wire clamps, and insulators. Featuring special traps made of PTFE-insulated coax (much lighter than conventional traps) with high Q and low losses, these weatherproofed, temperature-resistant, and shortened antennas are great for regular use or when there's not enough space for a full-size dipole. They can be mounted horizontally or in an inverted-V configuration with a required central support.



Choose from a range of options, from the 40/20/15/10M Single Trap 400W Wire Ground Plane model (KEL-11505-4251, \$122.99) to the 80/40/20/15/10M 2kW Trap Dipole model (KEL-11500-84251H, \$439.99). Enter "Kelemen" at DXEngineering.com for the full lineup.

EMCOMM-II Version 2 and EMMCOMM-III Portable HF Antennas

Specially designed for backup emergency HF system or permanent installation, Version 2 of the rugged EMMCOMM-II wire antenna delivers excellent 160-6M coverage and handles 500W SSB, 250W CW and 100W Digital. Add your external tuner and it makes a perfect backup or portable HF antenna for your station. The antenna comes with 60' of antenna wire and a waterproof matching box. Designed for short- to long-range portable and man-pack HF communications, EMMCOMM-III antennas are a great solution for backpacking and camping, as well as military, Civil Air Patrol, ARES, and RACES applications. Deployable in less than 15 minutes using almost any available support (no masts or guying required), they can be configured for NVIS communication and will support frequency-hopping and spread-spectrum modes/operations. The 160-10M version comes with matching transformer, a 73' copper-clad KEVLAR PTFE antenna wire on a line winder, and a 25' counterpoise. The 80-10M version comes with matching transformer and 130' of wire. An antenna tuner or coupler may be required.



CHA-EMCOMM-II Version 2, EMMCOMM II Portable HF Antenna\$159.99
 CHA-EMCOMM-III-B 80-10M 130' Base Antenna, 500W SSB or 250W CW\$194.99
 CHA-EMCOMM-III-P 160-10M Portable Antenna, 100W SSB or 50W CW\$189.99

Wire Antenna Hanging Tools

No more ladders, no more climbing trees—these durable wire antenna launching tools make it easy for you to hang your antenna from the safety of terra firma. In addition to heavy lead weights, they use tennis ball weights; so you won't damage anything if your aim is a bit off.

The Square Shot has a 300 foot spool of 10-pound-test line, an EZ winder with 500 feet of 155-pound-test line, and an easy hang custom band set. The Hyper Shot takes everything included with the Square Shot, and dials up enough power to clear trees up to 100 feet high! Make sure to check local laws regarding slingshots before you pull back the band on an EZ Hang kit.



EZH-EZHSSK1 Square Shot Kit\$99.99
 EZH-EZHSSKBL Hyper Shot Kit\$104.95

DX ENGINEERING

NVIS Antenna Kit

DX Engineering now makes it easier than ever to use NVIS (Near Vertical Incidence Skywave) techniques for emergency and recreational purposes. Used for decades in military applications and for in-state disaster communications, the ionospheric NVIS mode works at frequencies from 2 MHz to 10 MHz. Sturdy and easy to deploy, the DXE-NVIS-8040 kit is great for camping, QRP, ARES®, EMMCOMM, SPOTA, and any use where short range HF operation from 80 to 40 meters is preferred. The kit comes with a crossed dipole antenna capable of handling 1,500 watts. The antenna's stranded wires are 14 AWG. The support rope size is 5/16". The antenna weighs in at 25 lbs., perfect for taking on the road. Guying is provided by the antenna's four legs. The kit also includes a 15', 4-section telescopic fiberglass mast collapsible to 6' (DXE-TF15); cam lock clamps; ground stakes; low-loss 50 Ω coaxial cable; antenna support rope; and complete balun mounting kit (DXE-NVIS-BMB), featuring all-in-one bracket, DX Engineering end insulators, and stainless steel hardware. A DX Engineering DXE-MC20-1-1T balun is included.



DXE-NVIS-8040 Wire Antenna, 15' Mast, Balun Mounting Kit\$521.46

NVIS Shortened Dipole

This NVIS wire antenna kit features everything included with the DXE-NVIS-8040 but with loading coils to make the 80 meter dipole legs the same length as the 40 meter dipole legs.

DXE-NVIS-8040S NVIS Shortened Dipole Kit.....\$578.96



Par EndFedz® End-Fed Half-Wave Antennas

DX Engineering carries a range of full length low-power end-fed dipole antennas from the Amateur Radio pros at Par EndFedz®. A go-to choice for worry-free portable ops or stealth HOA installations, these versatile antennas can be mounted horizontally, vertically or as a sloper with no need for a ground plane or counterpoise. They feature a unique match box coax connection at the end of the wire for convenient and quick setup, whether hung from a tree limb, out of a hotel window, or in an attic. Stainless steel hardware and end insulators are included.

QRP End-Fed Half-Wave Antennas

Par EndFedz now offers single-band low-power HF models (25W SSB/CW, 12.5W Digital) covering 40, 30, 20, 17, 15, 12, 10, or 6 meters. Pricing from \$44.99 to \$59.99. Enter "PEZ" at DXEngineering.com for details on the full lineup. Enter "PEZ QRP 25W" for low-power models.

Part Number	Band(s)	Length	Power	Price
PEZ-EF-QUAD	40/20/15/10	65'	200W SSB/CW, 100W AM/DIG	\$154.95
PEZ-EFT-102040	40/20/10	41'	25W SSB/CW, 12.5W AM/DIG	\$89.99
PEZ-EF102040-239	40/20/10	41'	25W SSB/CW, 12.5W AM/DIG	\$89.99
PEZ-EF102040-BNC	40/20/10	41'	25W SSB/CW, 12.5W AM/DIG	\$89.99
PEZ-EF-4020	40/20	66'	100W SSB/CW, 25W AM/DIG	\$99.99
PEZ-EF-SWL	0-30 MHz	45'	Receive Only	\$74.99
PEZ-EF-6	6	114'	100W	\$62.99
PEZ-EF-10	10	16' 7"	100W SSB/CW, 25W AM/DIG	\$63.99
PEZ-EF-10H	10	16' 7"	300W SSB/CW, 150W AM/DIG	\$74.99
PEZ-EF-11	11	17' 6"	100W SSB/CW, 25W AM/DIG	\$66.99
PEZ-EF-17	17	25' 6"	100W SSB/CW, 25W AM/DIG	\$69.99
PEZ-EF-17H	17	25' 6"	300W SSB/CW, 150W AM/DIG	\$77.99
PEZ-EF-20	20	33'	100W SSB/CW, 25W AM/DIG	\$69.99
PEZ-EF-20H	20	33'	300W SSB/CW, 150W AM/DIG	\$79.99
PEZ-EF-30	30	46'	200W	\$78.99
PEZ-EF-40	40	65' 6"	200W	\$83.99
PEZ-EF-60	60	88'	100W	\$89.99
PEZ-EF-80	80	135'	100W	\$99.99
PEZ-EF-40-10-KW	40/20/15/10	64'	1 kW ICAS	\$169.95
PEZ-EF-8010-JRWK	80/40/20/15/10	74'	1 kW ICAS	\$189.95
PEZ-EF-ALLBANDKW	80-10M	132' 8"	1 kW SSB/CW, 250W AM/DIG	\$189.95

Join our crew on Facebook for news and exclusive deals!

Ranger 80 HF Portable Antenna Systems

Here's a smartly designed, highly transportable, and solidly built choice for your SOTA, POTA, IOTA, and ECOMM operations. The Ranger 80 kit from Texas-based REZ Antenna Systems comes with an adjustable, rugged base-load tuning coil that allows for tuning from 80-15M with the included seven-section tapered military whip made from brass and stainless steel (9.3' extended, 17" collapsed). Operation on 12M and 10M requires the use of an optional telescoping whip (sold separately) in place of the included whip. The unique manual-tuning sliding coil collar features a large contact area for worry-free power handling (200W SSB, 100W Digital at 50% duty cycle). The heavy-duty coil base comes with a REZ Radial Puck with eight 4mm holes. The kit also includes four 33' 18-gauge radials terminated with 4mm banana plugs for quick connection to the puck. The Ranger 80 and additional gear fit nicely in the provided laser-cut, water-resistant MOLLE backpack (your choice of five colors). Kits either include 17" ground spike mount or aluminum tripod mount.



REZ
ANTENNA SYSTEMS

REZ-RNGR80GS-BK	Ranger 80, Black Backpack, Ground Spike Mount.....	\$550.00
REZ-RNGR80GS-G	Ranger 80, Gray Backpack, Ground Spike Mount.....	\$550.00
REZ-RNGR80GS-OC	Ranger 80, Camo Backpack, Ground Spike Mount.....	\$550.00
REZ-RNGR80GS-OD	Ranger 80, Olive Drab Green Backpack, Ground Spike Mount.....	\$550.00
REZ-RNGR80GS-T	Ranger 80, Tan Backpack, Ground Spike Mount.....	\$550.00
REZ-RNGR80PD-BK	Ranger 80, Black Backpack, Tripod Mount.....	\$560.00
REZ-RNGR80PD-G	Ranger 80, Gray Backpack, Tripod Mount.....	\$560.00
REZ-RNGR80PD-OC	Ranger 80, Camo Backpack, Tripod Mount.....	\$560.00
REZ-RNGR80PD-OD	Ranger 80, Olive Drab Green Backpack, Tripod Mount.....	\$560.00
REZ-RNGR80PD-T	Ranger 80, Tan Backpack, Tripod Mount.....	\$560.00

Ranger 80 Radial Pucks

The REZ-ZQD-RP Radial Puck provided with the Ranger 80 kit can be purchased separately as an extra or replacement. The REZ-ZQD-RP-U is an upgraded universal model that allows you to work with the existing components of a Wolf River Coil tripod as well as any other SO-239 to 3/8"-24 adapter type mount.

REZ-ZQD-RP	Replacement Radial Puck.....	\$40.00
REZ-ZQD-RP-U	Universal Radial Puck.....	\$45.00

**Version 3.0 F-Loop Portable Antennas and RXL Receive Loop Antenna**

F-Loop antennas (version 3.0) deliver the exceptional performance hams have come to expect in a lightweight, compact package. They are ideal for camping, hotels, condos, HOAs, and other places where erecting a multiband wire or vertical antenna isn't possible. CHA F-LOOP 3.0 field trials have shown that an indoor magnetic loop antenna was only around one to two S-units lower, on both transmit and receive, than outdoor full-size quarter-wave vertical antennas—remarkable since it's less than three feet O.D. and covers 80-10M. These easily deployable HF magnetic loops feature an upgraded tuning box with a large Delrin knob for smoother tuning/operation, capacitors with a 6:1 tuning reducer, and an anodized aluminum base plate for flexible mounting. With power handling of 25W SSB/10W CW, the BASIC model provides a 34" LMR-400 coax cable radiator, a second coax loop extension, dual female connectors, proprietary solderless aluminum coupling loops, a three-section collapsible portable mast, a 12' RG-58 feedline with integrated RFI choke, and shoulder bag. The 30PLUS includes a deluxe collapsible aluminum loop element plus standard coaxial loop element and extension. The 30TOTAL comes with standard coaxial loop element, extension and 48" coaxial with 8" diameter coupling loop for increased performance, particularly on 60-20M.



CHA-F-LOOP-3-0

F-Loop 3.0 Portable Antenna

CHA-F-LOOP-3-0	80-10M.....	\$499.99
CHA-FLOOP30TOTAL	With 8" Diameter Coupling Loop.....	\$577.99
CHA-FLOOP30PLUS	With Deluxe Collapsible Aluminum Loop Element.....	\$649.99

CHA LRT Loop Remote Tuners

Made to work exclusively with the F-LOOP 2.0 or 3.0, these tuners deliver precise tuning while allowing the magnetic loop antenna to be mounted away from the operating position, such as on a balcony or deck. Operators control the tuner with a wired battery-powered control box featuring fast and slow tuning buttons.

CHA-LRT-2-0	Loop Remote Tuner for 2.0 F-LOOP.....	\$350.00
-------------	---------------------------------------	-----------------

Telescoping Whizz Whip Antenna

Give yourself the freedom of Moonraker's Whizz Whip Antenna—a completely self-contained, all-band 51" telescoping antenna that mounts right to your radio for super-convenient transmitting and receiving. Free your rig from coax cables, mounts, tripods, masts and trees, and enjoy remarkable performance from desktop to picnic table, with no ground required. It's the only HF portable antenna that not only operates VHF and UHF, but does so with gain. Transmits from 3.5 to 450 MHz. Take your rig anywhere you want to go and operate your QRP HF/VHF/UHF portable transceiver across the spectrum.



MKR-13-425	Telescoping Whizz Whip Antenna.....	\$149.99
------------	-------------------------------------	-----------------

**MPAS Lite Modular Portable Antenna Systems**

The "little brother" of the MPAS-2-0, the MPAS LITE provides HF and 6 meter coverage (100W SSB or 50W CW) and deployment flexibility. It includes Hybrid-Micro matching unit and portable base; 60 feet of antenna wire; 17-foot collapsible stainless steel whip; 50-foot coax with RFI choke; spike mount (for attaching the Hybrid HF antenna base and a counterpoise); and stainless steel hardware. The MPAS Lite with Hybrid-Mini Modular Antenna System can handle up to 500W SSB and 250W CW.



CHA-MPAS-LITE	Portable Antenna System, Hybrid-Micro Matching Unit.....	\$359.99
CHA-MPASMINILITE	Portable Antenna System, Hybrid-Mini Matching Unit.....	\$385.00

Universal Guying System

This portable system is made of non-conductive guy wire, corrosion-resistant stainless steel anchors, and heavy-duty nail pegs. System includes three winder assemblies; three lengths of 25 feet of 3mm-P Mastrant cord; nail plugs; line tighteners; and guy ring.

CHA-UGS	Universal Guying System.....	\$64.99
---------	------------------------------	----------------

CHA-LEFS-8010 Lightweight End-Fed Sloper Antenna

This minimalist 80-10M no-tuner antenna is made for outdoor operators who don't want extra bulk. It features a line winder with integral impedance matching network transformer, 20 gauge PTFE antenna KEVLAR wire, and 50 feet of Micro 90 paracord.

CHA-LEFS-8010	End-Fed Sloper Antenna.....	\$225.00
---------------	-----------------------------	-----------------

CHA-LEFS-4010 End-Fed Half-Wave Sloper Antennas

Elevate your portable ops with these 40/20/15/10M no-tuner antennas (30/17/12M is possible with a tuner). They come with 65 feet of 20 AWG wire, built-in winder with integral 49:1 impedance matching transformer, and carrying pouch.

CHA-LEFS-4010	End-Fed Half-Wave Sloper Antenna.....	\$174.99
CHA-LEFS4010-316	End-Fed Half-Wave Sloper w/25' of RG-316 Cable.....	\$249.99

Portable HF Tactical Delta Loop Antenna

Perfect for camping or temporary installation at houses with a small yard or antenna restrictions, the CHA-TDL operate on 80-6M but is most effective from 30-6M. It also provides NVIS propagation on 80-40M, making it a useful backup ECOMM antenna.

CHA-TDL	HF Tactical Delta Loop.....	\$399.99
---------	-----------------------------	-----------------

Multi-Configuration Coil and PRV Antenna Systems

This replacement coil provides base-loaded inductance for the 2-40M PRV-SOTA and PRV-POTA Portable Resonant Vertical (PRV) Antenna Systems. The coil (500W SSB, 300W CW, 200W Digital) is also compatible with the MPAS-2-0/MPAS LITE. PRV systems come with 58-inch telescoping whip, ground spike mount, puck hub, four 12.5-foot radial wires with winders, counterpoise wire, camera tripod adapter, and 12 feet of RG-58 coax with RFI choke. The POTA system includes universal clamp mount and extender rods.

CHA-MCC-Coil	Multi-Configuration Coil.....	\$349.99
CHA-MCC-PRV-POTA	2-40M PRV Antenna System, Heavy Kit.....	\$673.99
CHA-MCC-PRV-SOTA	2-40M PRV Antenna System, Light Kit.....	\$568.99

CHA Hub and Wire Kit

For use with the Chameleon Tactical Delta Loop (TDL) antenna, this kit comes with 25 feet of copper-clad Kevlar PTFE wire and hub for the TDL.

CHA-HUB-KIT	Hub and Wire Kit for CHA TDL.....	\$111.99
-------------	-----------------------------------	-----------------

Lightweight Portable Off-Center Fed Dipole

This antenna works without a tuner on 40/20/10/6M and with a tuner on 60/30/17/15/12M. It comes with a lightweight matching transformer, 66 feet of antenna wire in two segments, wire winder, and carrying pouch.

CHA-OCF-40	Off-Center Fed Dipole.....	\$89.99
------------	----------------------------	----------------

Four Pack of Antenna Wire Winders

These plastic winders (green, orange, tan, or yellow) make antenna deployment/tear down simple. Enter "**CHA 4 Winder**" at DXEngineering.com. Pricing from **\$27.00**.

Counterpoise Wire Kits

Ideal for creating ground plane radials, these kits (green, orange, tan, or yellow) include four lengths of 25-foot wire terminated with a 3/8"-inch ring that attaches to the base of the Hybrid MICRO or MINI, Jaw Mount, or other vertical base. Includes plastic wire winders and tent stakes. Enter "**CHA 25 Stake**" at DXEngineering.com. Pricing from **\$106.00**.

CHA-HUB-KIT	Hub and Wire Kit for CHA TDL.....	\$111.99
-------------	-----------------------------------	-----------------

CHA SS17 Stainless Steel Telescoping Whip Antenna

This 10-section whip extends to 17 feet and collapses to 27 inches. It can operate a full quarter wave from 6M-20M with manual adjustment without loading coil, or it can be combined with the CHA MPAS 2.0 as main radiator. Comes with 3/8"-24 base mounting.

CHA-SS17	Telescoping Whip Antenna.....	\$70.00
----------	-------------------------------	----------------

Tactical Dipole Antenna Kit 2.0

Designed for fast deployment and simple operation, the TD-2 operates from 1.8-30 MHz and is ideal for use with modern, digitally configured, HF rigs where features such as ALE and frequency hopping require true broadband capability. No masts or guying required. Includes two 60-foot lengths of PTFE wire and two 25-foot wires for counterpoise.

CHA-TD-2	Tactical Dipole Antenna Kit 2.0.....	\$449.00
----------	--------------------------------------	-----------------

Orders over \$99 qualify for FREE standard shipping—see pg. 74 for details.

Telescopic Masts

For convenient and worry-free portable operations, you can't go wrong with strong yet lightweight aluminum Telescoping Masts from WiMo. The masts' slotted aluminum tubing can be extended to the desired length and locked solidly in place with the attached clamps. Models are available from maximum heights of 13' to 52' in a variety of telescoped section counts (3 to 11) and top and bottom diameters. These versatile masts have a range of uses, including antenna construction, installation of weather stations, and mounting of monitoring cameras. Although the masts are primarily intended for temporary, portable use, they can also be installed permanently if properly fastened to serve as a guying point for a dipole antenna or other functions. The Metal Guy Ring Kit (WMO-23050) features a unique cable management slot that allows for the rotation of the mast while preventing the tangling of cables with the guys.



Enter "WiMo Telescopic" at DXEngineering.com. Pricing from **\$119.99** to **\$669.99**.

WMO-23046	Mast Clamp Quick-Release Handle	\$10.99
WMO-23050	Metal Guy Ring with Cable Management Slot and 4 Bushings Kit	\$61.99

Portable Mast Guying Rings

Sized for WiMo telescoping masts, these rings are made from fiberglass-reinforced plastic and come with three guying thimbles for secure rope attachment without binding or cutting. Rings anchor themselves at the mast clamp while allowing the mast to rotate even when anchored with guy ropes.

Portable Mast Guying Rings from **\$15.99**

Mast Tripods and Foot Plates

Perfect for EMCOMM, Field Day, SOTA, POTA, IOTA, or any occasion where you need a fast and hassle-free temporary installation, WiMo Tripods do the trick. They fold together in one simple move without any tools and collapse to a compact size for easy transport. Masts can be fixed within the tripods by means of two large tripod heads and secured by three knob screws. Legs fold out to a 3.5' radius. Tripod heads and legs are made of aluminum, and thread inserts are stainless steel. Choose from four models of differing heights and for mast base sections of 1" to 2.75" O.D. or 2" to 3.54" O.D. Sold in sets of three, aluminum Foot Plates can be used on the legs of your WiMo Tripod to stabilize it on sandy soil or keep it level on an incline.

WMO-18320	Mast Tripod for Masts of 1" to 2.75" O.D., Folds to 53"	\$279.99
WMO-18322	Mast Tripod for Masts of 1" to 2.75" O.D., Folds to 59"	\$299.99
WMO-18323	Mast Tripod for Masts of 1" to 2.75" O.D., Folds to 78.7"	\$249.99
WMO-18324	Mast Tripod for Masts of 2" to 3.54" O.D., Folds to 78.7"	\$309.99
WMO-18312	Mast Tripod Foot Plates (3)	\$89.99

Telescoping Fiberglass Masts

Choose from two WiMo fiberglass masts that make great choices for Field Day, POTA, SOTA, or temporary deployment in your backyard. The heavy-duty 18333-10 model features a 1.80" O.D. bottom tube with a wall thickness of 0.08" for safely handling wire antennas, VHF Yagis, or other small devices. With a bottom tube O.D. of 1.57", the 18333-6K also makes a reliable option for quick deployment just about anywhere. These reinforced telescoping masts are rigid, non-conductive, and easy to transport in your car or carry-on luggage.



WMO-18333-10	HD Fiberglass Telescoping Mast, 32.81', 3.3' Collapsed	\$99.99
WMO-18333-6K	Fiberglass Telescoping Mast, 19.69', 2.13' Collapsed	\$69.99



MPAS Portable HF Backpack Antenna Systems

Here's the perfect take-it-with-you answer for emergency preparedness and survival communication, or for Hams who enjoy camping, hiking, biking, or just about any kind of portable operating. The MPAS Portable HF Backpack Antenna System covers HF and 6 meters and can handle up to 100W SSB or 50W CW. The versatile system includes the Chameleon Hybrid-Micro matching unit and portable base, 113' collapsible whip antenna, 105.5' antenna extension, 50' coax with RFI choke, in-ground antenna mount, military-style olive green backpack, stainless steel hardware, and 75' of antenna wire and 25' of counterpoise wire to support a range of deployment configurations, including vertical, horizontal, sloper, inverted vee, inverted L, NVIS, balcony, stationary vehicle and man-pack. The MPAS 2.0 with Hybrid-Mini matching unit can handle up to 500W SSB or 250W CW. Enter "MPAS" at DXEngineering.com for full details.

CHA-MPAS-2-0	HF Backpack Antenna, Hybrid-Micro Matching Unit	\$599.99
CHA-MPAS-2-MINI	HF Backpack Antenna, Hybrid-Mini Matching Unit	\$625.00

DX ENGINEERING

Premier Telescoping Carbon Fiber Masts

When you demand superior long-lasting performance, these high-strength masts make an excellent choice for your portable and temporary antenna supports. Lighter than aluminum and fiberglass and stiffer than steel of the same thickness, they're available in three extended lengths (24', 33', and 49', plus a heavy-duty 33' option). They feature short section lengths designed for low-cost shipping and easy transport, with the 49' model collapsing to 81" and the other three masts sliding down to an impressive 69"—perfect for your outdoor adventures and EMCOMM deployments. These black, UV- and corrosion-resistant masts include adjustable lever-action cam-lock clamps that secure the next smaller tube in place and allow for fast and simple raising and lowering. The included 3mm Allen wrench lets you remove clamps for placement of optional guy rings and make adjustments to lever grips.



DXE-TCFP-33

DXE-TCFP-24	24' Mast, 4 Clamps, 5 Sections, Top O.D. 0.89", Bottom O.D. 1.40"	\$299.99
DXE-TCFP-33	33' Mast, 6 Clamps, 7 Sections, Top O.D. 0.89", Bottom O.D. 1.67"	\$469.99
DXE-TCFP-33HD	Heavy-Duty 33' Mast, 6 Clamps, 7 Sections, Top O.D. 1.27", Bottom O.D. 2.06"	\$599.99
DXE-TCFP-49	49' Mast, 9 Clamps, 10 Sections, Top O.D. 0.89", Bottom O.D. 2.06"	\$849.99



DXE-TCFP-24



Portable Antenna Poles

The Tactical TAC7000HDS is a heavy-duty fiberglass telescopic mast that's built tough for serious outdoor operators. The 23' mast collapses to 23" for easy transport, and the heavy-gauge pole sections combine strength, stiffness and proper weight for demanding applications. Other features include built-in base shock absorber and hollow top section for easy wire feeding. It makes a good complement to SOTABeams' Band Hopper antennas. The super-light MINI Telescopic Fiberglass Pole extends to 13' 6" with a closed length of only 20". Great for portable operations—especially cycling. Both poles include carrying bag. Also now available is the Tactical Mini Compact Ultra-Portable Telescopic Mast, built for easy transport in a backpack; and a guying kit for the Tactical Mini.



SBM-TAC7000HDS

SBM-TAC7000HDS	Heavy-Duty Portable Antenna Mast, 23' extended, 23" collapsed	\$99.99
SBM-MFGK-7000	Multi-Function Guying Kit for TAC7000HDS	\$33.99
SBM-MINI-POLES	MINI Telescopic Fiberglass Pole, 13' 6" extended, 20" collapsed	\$38.99
SBM-TACMINI	Mini Compact Ultra-Portable Telescopic Mast, 19.6' extended, 1.84' collapsed	\$79.99
SBM-MFGK-MINI	Multi-Function Guying Kit for Tactical Mini Mast	\$34.99
SBM-TACMININGUYPK	Guying Hardware Pack for Tactical Mini Mast	\$8.99



Carbon-6 Compact Ultra-Light Telescopic Mast

This mast fits nicely in a backpack for easy transport on your outdoor adventures. It extends to 19' and collapses to 17". Smooth telescoping of the mast's 18 sections ensures rapid deployment.

- Supports lightweight horizontal or inverted-vee antennas.
- The mast does not affect attenuation in a significant way. At worst, users may see a loss of less than 0.1 dB (measured with a coil wound around the mast).

SBM-CARBON-6	Compact Ultra-Light Telescopic Mast	\$57.99
--------------	---	----------------

MDCS-100 Drive-On Mast Mount

This mount makes it easy to operate from your parked car. Just drive a wheel onto the base plate and insert a mast into the steel sleeve. Pair it with the SOTABeams Compact Travel Mast (SBM-TRAVELMAST) for a complete portable solution.

SBM-MDCS-100	Drive-On Mast Mount	\$85.99
--------------	---------------------------	----------------

Horizon Loop Antennas

Capitalizing on the popularity of HF magnetic loops, Bushcomm's two Horizon Loops are a great solution for HF operation in a limited space. Whereas many popular magnetic loop models are receive only, these antennas actually allow tight-band transmit capability. Reception is characteristically quiet and transmission is remarkably efficient. They feature a durable, yet lightweight, aluminum loop and come with installation hardware. Horizon Loops handle 125 watts PEP.



BCM-LOOP-20

BCM-LOOP-20	Horizon Loop, 20-10M, 29" OD	\$399.99
BCM-LOOP-40	Horizon Loop, 40-10M, 54" OD	\$419.99

Need help with your project? Call the tech line at 330-572-3200!

Ciro Mazzoni
Radiocomunicazioni

Automatic Magnetic Loop Antennas

Own a stealthy loop antenna that can really handle the power. DX Engineering is proud to offer popular and proven "Loop Antennas by I3VHF"—the BABY Loop model (6.6-29.8 MHz) and MIDI Loop (3.5-14.5 MHz), both manufactured to the highest standards by Italy's *Ciro Mazzoni*. They're compact, quiet, easy-to-install and ideal when you're dealing with limited space but still want higher-power handling compared to other transmitting loops. Perfect for stealth HOA, these solidly constructed aluminum antennas include the ATU 2.0 Automatic Tuning Unit to resonate the loop throughout their wide frequency ranges: 80 through 20 meters for the MIDI Loop, 40 through 10 meters with the BABY, without any coverage gap. The ICOM-CAT-CBL interface cable for the ATU 2.0 unit in BABY, MIDI, and STEALTH loop antennas connects ICOM transceivers equipped with computer ports for frequency specific automatic tuning. Other brand radios are interfaced to the ATU 2.0 with RS-232 cables. **For complete details, enter "MZZ" at DXEngineering.com.**



MZZ-BABY	Loop Antenna, 6.6-29.8 MHz, 39.8" Diameter, with ATU 2.0	\$2,097.99
MZZ-MIDI	Loop Antenna, 3.5-14.5 MHz, 78.7" Diameter, with ATU 2.0	\$2,479.99
MZZ-BABY-TRIPOD	Tripod Stand for BABY Loop by I3VHF	\$149.99

Interface Cables

Interface cables for the ATU 2.0 are available for Icom, Yaesu, Kenwood, Elecraft, Flex, and Elad transceivers. **Pricing from \$49.99 to \$89.99.**



AlexLoop



AlexLoop HamPack Portable Magnetic Loop Antenna System

PYIAHD, Alexandre Grimberg brings more than five decades of Amateur Radio experience and a passion for portable HF operation to the new AlexLoop HamPack, the ultimate portable magnetic loop antenna solution for the outdoor radio operations enthusiast and the space-restricted Ham. Building on the success of his Walkham model, the HamPack system comes with the widely acclaimed AlexLoop. This lightweight and compact (three foot in diameter when assembled) transceiver QRP magnetic loop antenna for 40-10 meters can be easily taken into the field and assembled in less than two minutes. Bring it along for stealthy operating while on vacation, mounted in a window or on a balcony. Features include maximum power of 25W PEP SSB, 10W FM/AM and Digital; low-loss PL-259 connectors; and antenna tuning in five seconds on any frequency between 7 and 30 MHz. 8.5' coaxial cable with BNC connector included. How does it perform? Field tests have yielded more than 800 QRP DX contacts, including a distance world record.

For convenient transport, the antenna now comes with a full-size backpack featuring two reinforced pouches—one for accessories and the other to accommodate any size QRP rig. The large, precisely-printed scale that displays the range of frequencies, a very smooth geared tuning system, and the exclusive AlexTune LED Indicator make tuning this portable magnetic loop super easy. The AlexTune also works with other small transmit magnetic loop antennas (from 2 to 20 watts on SSB and 1 to 10 watts on CW/FM/Digital) that use PL-259 connectors and a coaxial cable radiator like the AlexLoop. The RC-2 HamPack Remote Tuning System eliminates the need to be near the antenna to make frequency and band changes. Easily select the desired band and frequency by turning the VFO-style knob. The Remote Tuning System can be purchased separately or as a combo with the AlexLoop HamPack Portable Magnetic Loop Antenna System.

ALX-HAMPACK	HamPack Portable Magnetic Loop Antenna	\$599.00
ALX-RC-2	HamPack Remote Tuning System	\$399.99
ALX-HAMPACK-RC-2	HamPack and Remote Tuning System Combo	\$998.99
ALX-ALEXTUNE	AlexTune LED RF Tuning Indicator.....	\$59.99

CHELEGANCE



Portable Vertical/Dipole Antennas and Active Indoor Shortwave Loop Antenna

Chelegance carries a nice selection of high-performance and sturdy portable antennas for your vacations, POTA, SOTA, IOTA, and other outdoor operations. The JPC-12 Portable HF Vertical Antenna (40 through 6 meter) is built for easy assembly and excellent performance. You receive a special antenna base with SO-239, ground stake, counterpoise wire set, manual tuning multi-band coil, heavy-duty aluminum tubes with threaded studs, stainless telescopic whip, and carrying bag. With a manually tuned center-mount coil and whip adjustments, expect good results from 7 MHz and up. It handles up to 100W and can be quickly put together to connect with a user-supplied coax for use on the go.

NCE-CH0010003	JPC-12 Portable HF Vertical Antenna	\$189.99
---------------	---	-----------------

JPC-7 Portable HF Dipole Antenna

This easy-to-deploy 100W power rated antenna covering 40 through 6 meters includes special antenna base, a 1:1 choke balun with SO-239 and connection leads, rotating arm bracket kit, brass connector, tripod adapter, manual tuning multi-band coils, heavy-duty aluminum arms, and two 98.4" stainless telescopic whips. The dipole kit comes packed into the provided 14.5" x 9" carrying bag but extends out to over 21.5' overall. Requires user-supplied tripod/mast and coaxial cable for portable use.

NCE-CH0010004	JPC-7 Portable HF Dipole Antenna.....	\$289.99
---------------	---------------------------------------	-----------------

MC-599 Portable Shortwave Dipole V Antenna

The MC-599 boasts versatile use with 40-6M coverage, 200W PEP power capacity, premium wire elements for top performance on 40M, compact dimensions for easy portability, and marking system on both telescopic whips for effortless tuning. With only five parts, assembly can be accomplished in about two minutes.

NCE-CH0010012	40-6M Portable Shortwave Dipole Antenna.....	\$299.99
NCE-CH0030029	Tripod and Mast for MC-599/JPC-7	\$95.99

MC-750 Portable HF Vertical Antenna

Covering 40 through 6 meters and handling up to 100W, this no-tools-required antenna system is easy to set up and disassemble. Its antenna base features a built-in ground spike, female SO-239 connector and jacks for up to four preassembled, 11.48' counterpoise radials (included). The antenna functions as a quarter-wave vertical ground plane antenna for the 14-50 MHz frequency range while using the included 17' telescoping whip. Also included is a loading coil for operating in the 7 MHz/40M band. The kit comes with a 1.64' extension, cable winder, and carrying bag.

NCE-CH0010009	MC-750 Portable HF Vertical Antenna	\$249.99
NCE-CH0030002	Tripod for MC-750/JPC-12/Other Antennas	\$39.99
NCE-CH0010009-P1	80M Tuning Coil for MC-750	\$65.99

Deshibo GA-450 Active Indoor Shortwave Loop Antenna

Boasting HF receive from 2.3-30 MHz (SW) and AM Broadcast receive from 522-1710 kHz (MW), this 8" diameter mini-loop antenna is an excellent addition whether you're at home or out of the shack in a camper or RV. It features a control base and BNC loop connector, gain control, USB-C charging port, internal battery, and female BNC output. You also receive male BNC-to-BNC and BNC to 3.5mm adapter cables for connection to your receiver and a USB-A to USB-C cable to connect charging power from a laptop (AC adapter not included).

NCE-CH0030010	Deshibo GA-450 Active Indoor Shortwave Loop Antenna	\$95.99
---------------	---	----------------



CHAMELEON™ ANTENNA

Spike Mount

Easily "plant" a 3/8"-24 stud mount into the ground for your portable antenna. This stainless steel mounting solution from Chameleon even features a thumb screw for using a counterpoise system. Please note that it requires an antenna with a separate feed point.

CHA-SPIKEMOUNT	Spike Mount	\$58.99
----------------	-------------------	----------------

Jaw Mount

Here's a quick, easy way to rapidly deploy your vertical mast. It's got a 3/8"-24 threaded mount on one end and a set of steel jaws on the other. The jaws will clamp securely on 3/4" to 2" OD tubing. The mount works in a vertical or horizontal orientation and will handle 250 watts PEP.

CHA-JAWMOUNT	Jaw Mount.....	\$65.99
--------------	----------------	----------------

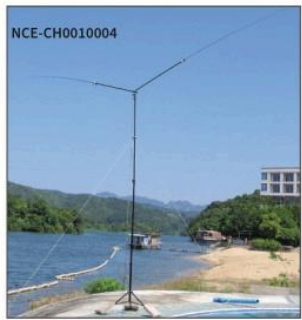

Orders by 10 pm ET ship the same day. See pg. 74 for details.

Ciro Mazzoni
Radiocomunicazioni

STEALTH Loop Antenna

From the loop antenna experts at Italy's **Ciro Mazzoni** comes the low-profile STEALTH Loop Antenna by 13VHF. Premiered at Dayton Hamvention 2018 and now available from DX Engineering, the 6.6-29.8 MHz continuous coverage STEALTH Loop measures only 54" x 19.6" x 10.2", making it ideal for keeping out of sight while letting you work the 40 to 10 meter bands. Made from strong, powdercoated aluminum alloy, the antenna features a typical SWR of 1.3:1; 6dB front to back ratio; 25dB front to side ratio; 50 Ω input impedance; and 125 watt power rating. It includes the ATU 2.0 Automatic Tuning Unit to resonate the loop throughout its wide frequency range. Weighing 15.4 pounds (without mounting brackets), the STEALTH Loop is an antenna built for high performance, without drawing the attention of your neighbors or HOA.



- MZZ-STEALTH 6.6-29.8 MHz Loop Antenna, with ATU 2.0 **\$1,799.99**
- MZZ-STEALTH-CAP Heavy-Duty Cast Acrylic STEALTH Capacitor Cover **\$169.99**

Ciro Mazzoni
Radiocomunicazioni

Serial Switch

The new Serial Switch for **Ciro Mazzoni** Loop Antennas by 13VHF allows you to simultaneously connect a PC, transceiver and your loop antenna's ATU 2.0 Automatic Tuning Unit. Featuring both RS232 and RS485 ports, the device lets you control your transceiver and the ATU 2.0 at the same time. Cable is provided to connect the device to your PC. Cables for connecting a transceiver and the ATU 2.0 are required.



- MZZ-SS232-USB Serial Switch for **Ciro Mazzoni** Loops **\$499.99**

HF Transmit Band Pass Filters and Multiplexers



Give your station the same high-quality band pass filters, diplexers, and triplexers used by top multi-multi contest stations and successful Field Day operations. Highly respected HF transmit band pass filters by Pavel, VA6AM, provide a dramatically lowered noise floor for enhanced single-band, weak-signal reception. The compact units (3" H x 6" W x 3" D) deliver the isolation needed to eliminate image and harmonic RF interference issues for dedicated monoband operations in multi-radio environments. The 150W PEP filters (Third Order Cauer for 80/40/20/15; Third Order Chebyshev for 160/10M) allow multiple transceivers to be operated on different bands simultaneously on the same antenna (with a required multiplexer below). Built into durable aluminum enclosures and supplied with SO-239 connectors, these filters boast 60 dB of out-of-band suppression, typical insertion loss of less than 0.25 dB, and return loss of less than 26 dB, equivalent to SWR under 1.1:1. **Enter "VA6AM" at DXEngineering.com for more details.**

- VAM-LP-BPF-160 160M Band Pass Filter, 150W PEP **\$165.99**
- VAM-LP-BPF-80 80M Band Pass Filter, 150W PEP **\$165.99**
- VAM-LP-BPF-40 40M Band Pass Filter, 150W PEP **\$165.99**
- VAM-LP-BPF-20 20M Band Pass Filter, 150W PEP **\$165.99**
- VAM-LP-BPF-15 15M Band Pass Filter, 150W PEP **\$165.99**
- VAM-LP-BPF-10 10M Band Pass Filter, 150W PEP **\$165.99**

Diplexers and Triplexers

When used along with a monoband HF band pass filter, these receive and transmit capable RF-filtering splitters/combiners allow multi-transceiver stations to share a single multiband antenna. VA6AM multiplexers deliver excellent levels of isolation between band ports and cause negligible insertion loss, while providing 50 Ω connections for multiple transceivers that serve to balance the impedances for a single 50 Ω feedline to a multiband antenna.

- VAM-LP-DIP-4080 80/40M Diplexer, 200W ICAS **\$245.99**
- VAM-LP-DIP-SPLIT 20/15/10M; 160/80/40M Split Diplexer, 200W ICAS **\$245.99**
- VAM-LP-TR-101520 20/15/10 Triplexer, 200W ICAS **\$259.99**
- VAM-LP-TR-204080 80/40/20M Triplexer, 200W ICAS **\$259.99**
- VAM-LP-TR-LBANDS 160/80/40M Triplexer, 200W ICAS **\$259.99**

AM Broadcast



Band Brick-Wall High Pass Filter

Live near a commercial AM station? Here's an effective way to combat its interference. Below 1.7 MHz, the filter hits unwanted signals with over 40 dB of attenuation. And it's virtually unnoticeable on the HF bands—there's less than 0.85 dB of loss with a SWR under 1.2:1. The filter is optimized for 50 Ω and installs between your radio and antenna (or amplifier/tuner). It handles 200 watts.



- DLW-FL1718 AM Broadcast Band Brick-Wall High Pass Filter **\$195.00**

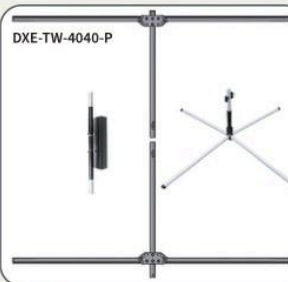

DX ENGINEERING

TransWorld Antenna Packages

If you enjoy portable HF operation, but don't enjoy lugging around a massive antenna, you should check out the TransWorld Antenna line. These antennas are small and portable, yet boast exceptional performance and durability. TransWorld Antennas are DX Engineering products, so they're built to the same precision standards that made TransWorld Antenna a household name for HF enthusiasts.



The DX Engineering TransWorld Antenna is essentially a basic structure consisting of top, bottom and tee sections with interchangeable Array Box Center Sections that you can purchase separately for the other bands you want. There are a ton of options; to make selecting the right antenna setup easier, we've created these handy packages.

5-Band Explorer

This combo delivers excellent 20, 17, 15, 12 and 10 meter coverage with manual bandswitching. It includes a portable QuadraStand, basic antenna structure, and a handy travel bag.

- DXE-TW-2010L-P 5-Band Explorer Package **\$888.95**

5-Band Adventurer

Similar to the 5-Band Explorer with the addition of automatic bandswitching. The travel bag is available separately.

- DXE-TW-2010-P 5-Band Adventurer Package **\$1,054.96**

Band-Specific Solo Explorer

This monoband antenna system gives you an impressive presence on the 40 meter band. It's an extremely portable package, and comes with QuadraStand and basic antenna structure components. Solo Explorers are available for the 80, 60, 40 and 30 meter bands; visit DXEngineering.com to see all the HF options.

- DXE-TW-4040-P 40 Meter Solo Explorer Package **\$748.96**

5-Band Globetrotter

Though it's a great portable antenna, the TransWorld Antenna is actually perfect for stealthy home installation too, when paired with the TransWorld Permanent Mounting Pole that's included in this package. Like the 5-Band Adventurer, the Globetrotter features 20-10M coverage with automatic bandswitching.

- DXE-TW-2010P-P 5-Band Globetrotter **\$956.96**

Band Switch Box Cover

- DXE-TW-COVER Band Switch Box Cover for TW-2010/2010L/3030/4040 **\$29.99**



SOTABeams Wire Antenna Kits



Band Hopper Multi-Band Portable Dipole Antennas

These lightweight, pre-assembled, resonant multi-band dipole antennas are designed for the lightweight portable specialist. With a high-efficiency, full-size, half-wave dipole on each band, operators can receive and transmit strong signals anywhere they go. The kit comes with RG174 feedline; BNC connector; ferrite core, current balun; three wire winders; tent stakes; 33' of back guy rope; and storage bag. These antennas are rated to 125W. Quick band selection is made possible with provided alligator clip jumpers.



SBM-BANDHOPPER4

- SBM-BANDHOPPER4 80/40/30/20 Meter Portable Dipole **\$119.99**
- SBM-HOPPER403020 40/30/20 Meter Portable Dipole **\$101.99**
- SBM-HOPPER4020 40/20 Meter Portable Dipole **\$89.99**

Bandspringer Midi HF Portable Antenna

This is a pre-assembled, lightweight random-length wire antenna with counterpoise designed for excellent transmitting and receiving performance on the 60/40/30/20/17/15/12/10 meter bands. It comes with two wire winders, two aluminum tent stakes, three insulators, two cable ties, 4mm to BNC adapter, and nylon carrying bag. Wire elements are made of high-quality PVC-insulated stranded wire. Requires the use of an antenna tuner, not included.

- SBM-SPRINGERMIDI 60/40/30/20/17/15/12/10M Midi HF Antenna, 42' **\$43.99**

Need advice? 1-330-572-3200 or DXEngineering@DXEngineering.com



Smart Antenna Control Consoles

Operate your multi-input, multi-output Hamplus Antenna Switch system using these consoles, one at each radio position. It won't matter whether your transceiver positions are together in a contest station or far apart in separate radio shacks in different rooms! These Memory Band Decoder control units connect directly with Elecraft, Icom, Kenwood and Yaesu rigs for antenna automation and easy switching between radios. Push-buttons and LEDs indicate manual or automatic antenna selections. They allow for split operation, using a separate transmit and receive antennas. A simple "one-radio-per-antenna" system and hot switch safeguards protect radios/antennas from damage. They require no PC or software, and work with all Hamplus rotator and antenna switches. Consoles support multi-controller, multi-Rotator Switches for memorization of antenna rotator selections. Optional two-way switch units make it possible to control up to 16 antennas by piggybacking two Smart Antenna Control Consoles per operating position. The HPY-MBD-8G comes with band data output, bandpass filter control output, and Waller Flag receive antenna control ports.

- HPY-MBD-8G MBD Remote Control Unit, for 8 Antennas, with Added Outputs/Ports **\$469.99**
- HPY-MBD-12F MBD Remote Control Unit, for 12 Antennas **\$659.99**
- HPY-SW-02 Serial Port Splitter Switch for MBD-8 **\$79.99**

2 Inputs to 1 Output Antenna Switch Relay Units

These remotely controlled units work with two 8-port antenna switches to expand to 16 antennas. Boasting 3,000W PEP power handling and DC to 60 MHz coverage, they feature SO-239 RF connectors and DB-9F for remote control. Port isolation is 38 dB at 30 MHz. The ASR-21 model lets you expand from 4 to 8 rotators.



- HPY-AS-21 2 Input/1 Output Antenna Switch Relays **\$199.99**
- HPY-ASR-21 2 Input/1 Output Antenna Switch Relay w/Rotator Expansion **\$199.99**

Transceiver Radio Interface Cables and Control Cable Assemblies

These cables for Icom, Yaesu, Kenwood, Elecraft, and Flex rigs are necessary to complete the connection of each smart Remote Control Console or Desk Antenna Switch with its transceiver. Choose based on your radio/interface model. Control Cable Assemblies connect Hamplus Smart Antenna Control Consoles with Antenna Switches. **Pricing for interface cables from \$55.99 to \$77.99. Enter "HPY Interface" at DXEngineering.com for more details.**



Control Cable Assemblies			
HPY-CC-10M	10 Meters Long	MBD-8/12 to AS82-AS1206	\$65.99
HPY-CC-15M	15 Meters Long	MBD-8/12 to AS82-AS1206	\$79.99
HPY-CC-20M	20 Meters Long	MBD-8/12 to AS82-AS1206	\$119.99

SO2R 2X6 Antenna Switches

These finely made antenna switches by VE2DX let users select any six antennas for connection to two radios, covering the frequency range of 1.8 to 54 MHz (1,500W SSB/CW). All control signals are RFI filtered as are all VE2DX printed circuit boards with shielding on both sides. Each SO-239 antenna port features five relays to achieve a design with over 80 dB of port isolation and full legal-limit power handling. Built into a weatherproof chassis (11" W x 7.75" H x 4" D), the switch's simplistic design allows the use of only two coaxial cables from the station to the tower. Both radio inputs have access to any of the unselected six antenna outputs. Switches may be controlled by third-party switch consoles, station controllers, and computer automation. Available in 12 and 24 VDC versions.



- VE2X-26AS-12 2X6 Antenna Switch, 12 VDC **\$624.99**
- VE2X-26AS-24 2X6 Antenna Switch, 24 VDC **\$624.99**



Coax Switches

These low-loss devices provide smooth switching between antenna systems. The two-position, 0 to 1000MHz 18-041 model handles 2,500W maximum power with an insertion loss of 0.1dB. The 21-400 two-position switch boasts a 1000MHz range; 2kW (DC-30MHz), 1kW (30-200MHz), 500W (200-500MHz), 250W (500-1000MHz) power handling; and 0-500MHz 0.05dB/500-1GHz 0.10dB insertion loss. The DC-800MHz 21-401 three-position switch has SO-239s, an insertion loss of less than 0.05dB; and 0-30MHz (1.5kW), 30-200MHz (1kW), 200-500MHz (500W), 500-800MHz (250W) power handling.



- MKR-18-041 2-position SO-239 Coax Switch, 1000MHz **\$29.99**
- MKR-21-400 2-position SO-239 Coax Switch, 1000MHz **\$69.99**
- MKR-21-401 3-position SO-239 Coax Switch, 800MHz **\$109.99**

We're All Elmers Here! Get Expert Support at: Elmer@DXEngineering.com

Antenna Switches

These excellent solutions for switching multiple antennas to multiple radios support 6, 8 or 12 antenna inputs and 1, 2, 4 or 6 radio outputs. They cover HF and 6M bands and handle full legal limit power with insertion loss of 0.1 dB. They allow one radio to access one antenna at a time. All antennas are grounded when not selected or when the system is powered off. These devices are typically operated automatically or manually with the illuminated push-buttons of the MBD-8E, MBD-8G or MBD-12F Smart Antenna Switch Control Units, one at each radio position.



The RC-12 Manual Control Unit comes with rotary knob and LEDs to indicate antenna selection. They operate any of the remote antenna switches and can also be used at each radio position.

Part Number	Radio Inputs	Antenna Outputs	Max. SWR	Price
HPY-AS-62	2	6	1.8:1	\$521.99
HPY-AS-81S	1	8	1.7:1	\$259.99
HPY-AS-82F	2	8	1.7:1	\$649.99
HPY-AS-84F	4	8	1.7:1	\$1,289.99
HPY-AS-86F	6	8	1.7:1	\$2,195.99
HPY-AS-1202F	2	12	1.7:1	\$999.99
HPY-AS-1204F	4	12	1.7:1	\$1,599.99
HPY-AS-1206F	6	12	1.7:1	\$3,295.99
Control Unit				
HPY-RC-12	Manual Control Unit for up to 12 Antennas			\$179.99



6-Antenna Smart Control Console

The MBD-62 provides intelligent control for up to six antennas and two radios. It's compatible with all Hamplus antenna switches and those from select other manufacturers. Suitable for use with the new Hamplus AS-62 antenna switch, the controller features two band decoders; two outputs for triggering band pass filters; 16 general purpose outputs (eight for each radio); two manual and two automatic ways to select antennas; antenna memory capabilities, with 25 bands that cover from 100 KHz to 450 MHz; split antenna operation (one antenna transmits and one receives); software updates via USB; and more. The MBD-62 recognizes Icom CI-V, Yaesu and Elecraft BCD, and Kenwood, Icom and Elecraft RS-232 radios.



- HPY-MBD-62 Smart Antenna Control Console, 6 Antennas/2 Radios **\$489.99**
- Pin to Pin Cables**
- HPY-CC62-5M For MBD-62 to AS-62 Antenna Switcher, 5 Meters Long **\$39.99**
- HPY-CC62-9M For MBD-62 to AS-62 Antenna Switcher, 9 Meters Long **\$52.99**
- HPY-CC62-15M For MBD-62 to AS-62 Antenna Switcher, 15 Meters Long ... **\$69.99**
- HPY-CC62-20M For MBD-62 to AS-62 Antenna Switcher, 20 Meters Long ... **\$81.99**

Automatic Remote Antenna Switch System for 6 Antennas, 3 Radios

The new AS-61WL antenna switch unit comes with a separate indoor control console (RC-603WL) featuring easy-to-use push-button controls for quick selection of six antennas and up to three radios. The RF-capable control console also allows for the insertion of a linear amplifier, wattmeter or both. Any length of 50 Ω cable connects between the two units to carry full power RF and commands. The control console is an intelligent band decoder with antenna selection memory. It features automatic band memory operation with compatible transceivers including Elecraft K3 (RS-232), Kenwood (RS-232), Yaesu CAT (RS-232) and Icom (CI-V); operation from 1.5 MHz to 60 MHz; maximum 0.1 dB insertion loss; and the ability to handle 2,500 watts PEP. Provides non-simultaneous six-antenna operation to one of three radios. All antennas and radios are switched to ground when not in use. SO-239/UHF female connectors.



- HPY-AS-61WL Automatic Antenna Switch, 6 Antennas/3 Radios **\$699.99**

Desktop Antenna Switches

Hamplus AS-603 Desktop Manual Switches feature six antenna inputs and three radio outputs for quick, one-at-a-time rotary switch selections. Hamplus AS-603A Desktop Smart Antenna Switches feature illuminated push-buttons, indications of six antenna inputs and three radio output selections. Built-in intelligent band decoder and antenna memory allows effortless automatic or manual antenna band switching. The AS-603A is compatible with popular Elecraft, Kenwood, Yaesu and Icom transceivers or any radio equipped with a BCD.



- HPY-AS-603 Desktop Antenna Switch **\$379.99**
- HPY-AS-603A Desktop Smart Antenna Switch **\$399.99**
- HPY-AS-603AL Desktop Smart Antenna Switch, w/Amplifier Connectors **\$475.99**



Manual Antenna Switches

- Alpha Delta antenna switches have precision-machined, low loss components for reliable service. Grounded unselected antenna ports and ARC-PLUG™ lightning surge protectors provide the final line of protection. Rated at 1,500 watts max. up to 30 MHz.
- ALF-DELTA-2B 2-Position Coax Switch, SO-239 Connector **\$119.99**
 - ALF-DELTA-2B-N 2-Position Coax Switch, N Connector **\$129.99**
 - ALF-DELTA-4B 4-Position Coax Switch, SO-239 Connector **\$139.99**
 - ALF-DELTA-4B-N 4-Position Coax Switch, N Connector **\$149.99**
 - ALF-ASC-4B 4-Position Desk Console Switch, SO-239 Connector **\$209.99**
 - ALF-ASC-4B-N 4-Position Desk Console Switch, N Connector **\$219.99**
 - ALF-D4 Replacement ARC-PLUG **\$14.00**

Manual Antenna Switches

Perfect for switching one radio between two antennas (or two radios between one antenna), these rugged switches offer excellent isolation and auto-grounding of the unused terminal for extra protection.



DWA-CS-201A

Daiwa's CS-201GII has a frequency range up to 2 GHz, 50 dB of isolation at 1 GHz and an insertion loss below 1.2 dB at 1.2 GHz. Gold plated N connectors make for easy installation.

The CS-201A has a frequency range up to 600 MHz, 60 dB of isolation at 600 MHz and an insertion loss under .2 dB. This switch features SO-239 connectors.

- DWA-CS-201GII Manual Coax Switch, 2 GHz **\$59.99**
- DWA-CS-201A Manual Coax Switch, 600 MHz **\$37.99**



DMN-CX210N

DMN-CX310A

Wideband Coax Switches

Maximum performance without compromise. Diamond Antennas offers an extensive line of station accessories: duplexers/triplexers, switches, dummy loads and lightning protection. Maximize your installation; Diamond Antennas has the gear to help you do it.

Part Number	Description	Price
DMN-CX210A	Wideband Coax Switch, 1,500W Max., DC-1000 MHz, SO-239	\$56.99
DMN-CX210N	Wideband Coax Switch, 1,500W Max., DC-1000 MHz, N Connector	\$79.99
DMN-CX310A	Wideband Coax Switch, 3-Position, 1,500W Max., DC-800 MHz, SO-239	\$92.99
DMN-CX310N	Wideband Coax Switch, 3-Position, 1,500W Max., DC-800 MHz, N Connector	\$99.95

RemoteBox Universal Antenna Switch Controllers



A great choice for remote antenna control, these controllers use RemoteBox Manager software (included) and band data interface cable to add incredible functionality to your station. Controllers work with DX Engineering's 1 output/8 antenna (1x8) DXE-RR8B-HP and DXE-RR8B-SD, or 2x8 DXE-RR2X8B, and other brands of 1x6, 1x8, 2x6, and 2x8 remote antenna switches. Enter "RemoteBox" at DXEngineering.com for more details.

- ETX-REMOTEBOX1X6 Switch Controller, 1 Output, 6 Antennas **\$175.99**
- ETX-REMOTEBOX1X8 Switch Controller, 1 Output, 8 Antennas **\$209.99**
- ETX-REMOTEBOX2X6 Switch Controller, 2 Outputs, 6 Antennas **\$249.99**
- ETX-REMOTEBOX2X8 Switch Controller, 2 Outputs, 8 Antennas **\$249.99**

RX Audite SDR Antenna Switch Controllers



New!

From longtime contester Jan Sustr, OK2ZAW, of QRO.cz, the RX Audite lets hams monitor the amateur radio bands with an SDR while simultaneously operating on one or more of those bands. This handy device (100 kHz-60 MHz; 200W transmit power handling) combines the functionality of a T/R switch, a receive antenna input, and a receive splitter with specialized switching. The transmit/receive main antenna can be shared with both outputs, transceiver and receiver (SDR) with RF power limiter protection. It's ideal for use with a separate SDR receiver for spectrum panadapter, WebSDR, or as a skimmer server to contribute spots to the Reverse Beacon Network. Available with or without internal preamplifier. Enter "Audite" at DXEngineering.com for more details.

- QRO-RX-AUDITE RX Audite SDR Antenna Switch Controller **\$329.99**
- QRO-RX-AUDITEPRE RX Audite w/RX Preamplifier **\$345.99**



Remote Antenna Radio Switches

DX Engineering uses a symmetrical design in these switches to ensure excellent reliability and performance. Installation is easy too. Simply use the switch's external control cable connector to attach your CAT-5 cable to the controller in your shack.

These switches provide great SWR and superior port-to-port isolation—better than 60 dB for ALL ports, not just the best port. You'll see 70 dB (HP) and 60 dB (SD) in worst-case scenarios. That's the highest port isolation of all the major-brand coax switches we've tested.

They're fully RF-shielded with a UV-resistant cover, and have built-in lightning protection. The unused antenna ports can be jumpered for open control line with no disassembly or they can be easily shorted to ground.

High Performance (HP) and Severe Duty (SD) Options

The DXE-RR8B-HP uses 16 relays (2 per port) in a star arrangement to provide greater than 70 dB of port-to-port isolation. It is designed to switch coaxial lines in RF systems operating up to 5 kW continuous duty. The DXE-RR8B-SD is the largest switch in the RR8B series, designed to switch coaxial lines in high power RF systems up to 10 kW continuous duty.

Specifications

- Sealed RF Relays: 20 amps (HP), 25 amps (SD)
- Power Rating: (<2:1 SWR at 30 MHz): 7 kW ICAS/5 kW CCS (HP), 10 kW ICAS/CCS (SD)
- Control Voltage: 10-14 Vdc/100 mA (HP), 10-14 Vdc/160 mA (SD)
- Loss (HP): <0.03 dB below 60 MHz, <0.25 dB below 150 MHz
- Loss (SD): <0.03 dB below 30 MHz, <0.16 dB below 60 MHz
- Impedance: 50 Ω
- Control Line: 8-wire plus ground, #24 up to 1,000' (DXE-CW9S)

Single-Input 8-Port RF

Switches and Console Combos

- DXE-RR8B-HP 5 kW Key-Down Switch **\$515.99**
- DXE-RR8B-HP-P1 5 kW Key-Down Switch with CC-8A Console **\$785.98**
- DXE-RR8B-HP-P2 5 kW Key-Down Switch with EC-8 Console **\$705.98**
- DXE-RR8B-SD 10 kW Key-Down Switch **\$562.99**
- DXE-RR8B-SD-P1 10 kW Key-Down Switch with CC-8A Console **\$832.98**
- DXE-RR8B-SD-P2 10 kW Key-Down Switch with EC-8 Console **\$752.98**

Accessories

- DXE-RLY-HP SPDT 5 kW Sealed RF Relay, Board-Mount **\$12.99**
- DXE-RLY-SD SPDT DM/DB 10 kW RF Relay, Board-Mount **\$24.99**
- DXE-CW9S Shielded Control Wire, 9-Conductor Stranded per foot **\$1.59**

EC-4 4-Position Control Console

The DXE-EC-4 is a flexible, four-position controller used to control the DX Engineering Receive Four-Square series or any other product using a four-position (three wire plus ground) BCD control format. It features a powdercoated housing with an ON/OFF switch and green LEDs with scratchpad areas to mark the switch position function. It requires 12 Vdc for operation.

Additional Features:

- Stainless steel housing
 - Non-steel feet
 - Four green position-indicating LEDs
 - An internal automatic resettable fuse
 - Includes a 2.1mm power plug for +12 Vdc power connection
- DXE-EC-4 4-Position Control Console **\$171.99**



CC-8A Deluxe 8-Position Control Console

The CC-8A is a flexible 8-position controller for DX Engineering RR8 Series Antenna Switches or any other product that uses a 12/24 Vdc, 1-of-8 or BCD control format. The powdercoated metal housing features an on/off switch, ergonomic selector knob, and eight front-panel LEDs (with adjustable brightness) to indicate switch position. It has a stainless steel base plate and operates from a 12 Vdc or 24 Vdc source.

- DXE-CC-8A Deluxe 8-Position Control Console **\$269.99**



EC-8 8-Position Control Console

The EC-8 is a versatile 8-position controller for DX Engineering RR8A Series Antenna Switches, or any other product that uses a 12/24 Vdc, 1-of-8 control format. The powdercoated metal housing features an on/off switch with green power LED and an ergonomic selector knob with scratchpad areas to mark the switch position function. It has a stainless steel base plate and operates from a 12 Vdc source.

- DXE-EC-8 8-Position Control Console **\$189.99**



Visit DXEngineering.com for the latest limited-time offers and special savings!



**Multi-Band High-Performance
43 Foot Vertical Antenna Packages
With SAF-T-TILT™ Base**

If you want to work DX, but don't have the real estate for an antenna farm, these packages are an excellent solution. They deliver exceptional multi-band performance with a compact size and attractive price. These easy-to-set up, easy-to-use packages cover the entire HF band, from 160 to 10 meters.

The rugged 43' antenna employs a free-standing, fast taper design that can survive winds up to 92 mph. It's made from 6063-T832 drawn aluminum and features stainless steel hardware for excellent corrosion resistance. Each package below includes the DX Engineering's exclusive patented SAF-T-TILT™ base, which lets you safely raise and lower your antenna for service.

The MBVE-5A antenna requires DX Engineering's UN-43 UNUN and a wide-range tuner. You'll also need 150' of RG-213 cable, sold separately. For optimum results, we recommend a good ground radial system (32 radials, each 32' to 65' long). You can get by with fewer radials with diminished performance.

We've created kits that bundle together some of the essential components. A brief summary is below; a comprehensive description of each combo is at DXEngineering.com.

DXE-MBVE-5A	Package, Antenna and Tilt Base.....	\$601.98
DXE-MBVE-5A-4P	Package, Antenna, Tilt Base, Radial Plate, Hardware.....	\$741.64
DXE-MBVE-5A-4UP	Package, Antenna, Tilt Base, UNUN, Mounting/Connection Kit.....	\$846.95
DXE-MBVE-5A-4UPR	Package, Antenna, Tilt Base, Radial Plate, UNUN, Mounting/Connection Kit.....	\$986.61
DXE-MBV-200S	Replacement 2" Saddle Clamp.....	\$15.49



DXE-MBVE-5UG-BRT



DXE-MBVE-5UG-BRT

43' Verticals and Remote Antenna Tuner Mounting Kits

It's important to mount your MFJ remote antenna tuner as close as you can to your DX Engineering MBVE-5A multi-band vertical antenna to maintain signal efficiency. Just make sure to protect it from weather, rising water and curious critters.

Use DX Engineering's new remote antenna mounting kits. They attach right to the base of the vertical. More importantly, they'll mount the tuner up off the ground—away from Mother Nature and her furry friends.

Select your kit based on your tuner model; the MFJ 927, 993, 994 and 998 remote tuners are supported.

DXE-MBVE-5AE-BRT	Mounting Kit, for MFJ-993/994BRT.....	\$680.97
DXE-MBVE-5AEBRT3	43' Vertical and Mounting Kit, MFJ-993BRT Tuner.....	\$1,208.99
DXE-MBVE-5AEBRT4	43' Vertical and Mounting Kit, MFJ-994BRT Tuner.....	\$1,308.99
DXE-MBVE-5AE-RT	Mounting Kit Only, for MFJ-998RT.....	\$712.97
DXE-MBVE-5AERT8	43' Vertical and Mounting Kit, MFJ-998RT Tuner.....	\$1,790.99

Remote Antenna Tuner Mount Upgrade Kits

If you have an earlier model MBVE-5, you can also upgrade to the 5AE mount with these kits.

DXE-MBVE-5UG-BRT	Upgrade Kit, for MFJ-993/994BRT.....	\$211.97
DXE-MBVE-5UGBRT3	Upgrade Kit, Includes MFJ-993BRT Tuner.....	\$611.92
DXE-MBVE-5UGBRT4	Upgrade Kit, Includes MFJ-994BRT Tuner.....	\$711.92
DXE-MBVE-5UG-RT	Upgrade Kit, for MFJ-998RT.....	\$243.97
DXE-MBVE-5UGRT8	Upgrade Kit, Includes MFJ-998RT Tuner.....	\$1,193.92

Prices are subject to change without notice.

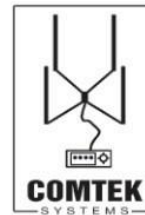

Vertical Antennas and Arrays

These rugged, affordable quarter-wave antennas are designed to be used in sets to provide top performance with phased vertical array systems like the COMTEK PVS 2-antenna systems or COMTEK and DX Engineering Four-Square array controllers.

The COM-20VA antenna can be used on any single band—20, 17, 15, 12 or 10 meters—by adjusting its length.

Constructed from 6063 aircraft-spec aluminum tubing, these antenna taper from a huge base section. High strength, UV-resistant EXTREN® insulators and a heavy aluminum plate mounting base ensure long lasting, reliable performance under adverse conditions. The antennas come with V-saddle clamps for installation to your ground-mounted pipe; 2" OD pipe is recommended, but the clamps will accept any size from 1" to 2". Stainless steel hardware included. Light rope guying is always recommended for phased systems to keep spacing precise and minimize swaying.

20 Meter Vertical Antenna

COM-20VA	20M Vertical Antenna.....	\$189.99
COM-20VA-2P	20M Vertical Antenna, Set of 2.....	\$379.98
DXE-TB-8P	Tilt Base, Kit.....	\$134.98
COM-20VA-4P	20M Vertical Antenna, Set of 4.....	\$759.96

30 Meter Vertical Antenna

COM-30VA	30M Vertical Antenna.....	\$299.99
COM-30VA-2P	30M Vertical Antenna, Set of 2.....	\$599.98
COM-30VA-4P	30M Vertical Antenna, Set of 4.....	\$1,199.96
DXE-TB-7P	Tilt Base, Kit.....	\$134.98

40 Meter Vertical Antenna

COM-40VA	40M Vertical Antenna.....	\$325.99
COM-40VA-2P	40M Vertical Antenna, Set of 2.....	\$651.98
COM-40VA-4P	40M Vertical Antenna, Set of 4.....	\$1,303.96
DXE-TB-7P	Tilt Base, Kit.....	\$134.98

See page 62 for Radial Plates and Radial Wire Kits to complete your antenna installation.



Check out our blog, OnAllBands.com, for articles on upcoming DXpeditions, what's new in contesting, digital operations, and a range of other topics.

Want more? We've got loads of tech videos and interviews on the DX Engineering YouTube channel. Of course, when you want personal attention, our experts are only an email or phone call away.



DXE-8040VA-1



DXE-4030VA-1

THUNDERBOLT® Dual-Band High-Performance Vertical Antennas

80/40 Meters

- Full band coverage on 40 and 300 kHz on 80 meters with SWR under 2:1—no outboard tuner needed
- Tunable above and below 7 MHz range for MARS and CAP frequencies
- Maximum legal power handling
- Optimum 53' overall height
- Includes Pivot Base (Shown on page 61)
- Self-supporting design withstands 50 mph wind without guying—easy raising and lowering with optional winch kit

DXE-8040VA-1	80M Vertical Antenna	\$2,019.97
DXE-VRW-1	Manual Winch Kit	\$287.99
DXE-7580-THK	CW Optimizer Capacity Hat.....	\$89.99
DXE-8040-30AOK	30 Meter Add-On Kit.....	\$222.99

40/30 Meters

- Full band coverage on 40 and 30 meters with SWR under 1.5:1—no tuner needed
- 40M bandwidth greater than 750 kHz with SWR under 2:1
- Tunable above and below 7 MHz range for MARS and CAP frequencies
- Maximum legal power handling
- Includes Tilt Base
- Optimum 30' overall height
- Self-supporting design withstands 60 mph wind without guying

DXE-4030VA-1	40/30M Dual-Band Antenna...	\$569.98
--------------	-----------------------------	-----------------

DX ENGINEERING

Manual Winch Add-On Raising Kit

DX Engineering's Manual Winch Add-On Raising Kit lets you easily raise and lower your DX Engineering vertical antenna by yourself, which makes antenna service a much easier job. The kit can be moved from one compatible DX Engineering antenna to another, making it a valuable tool for multi-antenna arrays. This kit works with many of DX Engineering's Vertical Antennas and is an excellent complement to its Heavy-Duty Pivot Base.



Features:

- Automatic friction brake applies consistent grip to ensure controlled raising/lowering
- Automatically holds antenna position
- Handle won't spin under load
- Meets ASAE safety standard S361.3
- Rated at 1,500 lbs.
- Minimum operating load is 75 lbs.
- 2.5" diameter drum hub
- 5.1:1 gear ratio
- Zinc Tuffplate finish
- Winch strap (2" W x 15' L) with hook and loop, manufactured from low-stretch polyester webbing with 4,000 lbs. break strength
- Stainless steel hardware

DXE-VRW-1	Manual Winch Add-On Kit	\$287.99
-----------	-------------------------------	-----------------

(Wires enhanced for clarity)

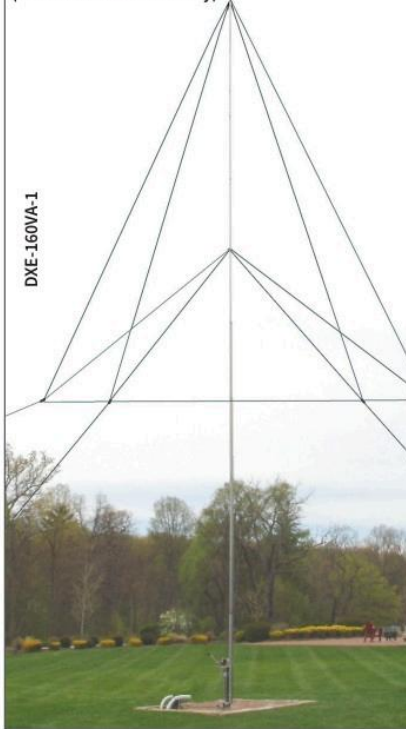

High-Performance DX ENGINEERING 160 Meter Quarter-Wave Vertical

Now you can have a high-performance vertical antenna specifically for the 160 meter band. Achieve the strongest possible presence at your power level and be really competitive! This custom-designed capacity hat system integrates with light rope guying, allowing you to get on 160 meters with a BIG signal from a vertical monoband antenna that is only 55 feet tall! Constructed from aircraft-grade aluminum, the massive three inch diameter lower section is secured by a Heavy-Duty Plus Stainless Steel Pivot Base, which can be lowered easily with the optional DXE-VRW One Man Manual Winch.

Antenna Features:

- 5 kW SSB and CW rated
- Unparalleled reliability
- A custom designed capacity hat for top performance
- An adjustable matching network for the lowest SWR
- 40 kHz SWR bandwidth - CW+DX Phone
- The lowest takeoff angle reduces domestic QRM signals

DXE-160VA-1	160M Vertical Antenna	\$1,664.97
DXE-VRW-1	Manual Winch Add-On Kit	\$287.99



EA6J 6 Meter Vertical Antenna

Based on the time-tested J-pole design, EA6J delivers 2 dBi gain and a 2 MHz bandwidth at 2:1 SWR. At just about 17' high, its a compact and cost-effective solution for 6 meter stations. It handles full legal limit power and will survive winds up to 80 mph.

EAN-R2010802	EA6J 6 Meter Vertical Antenna...	\$209.99
--------------	----------------------------------	-----------------

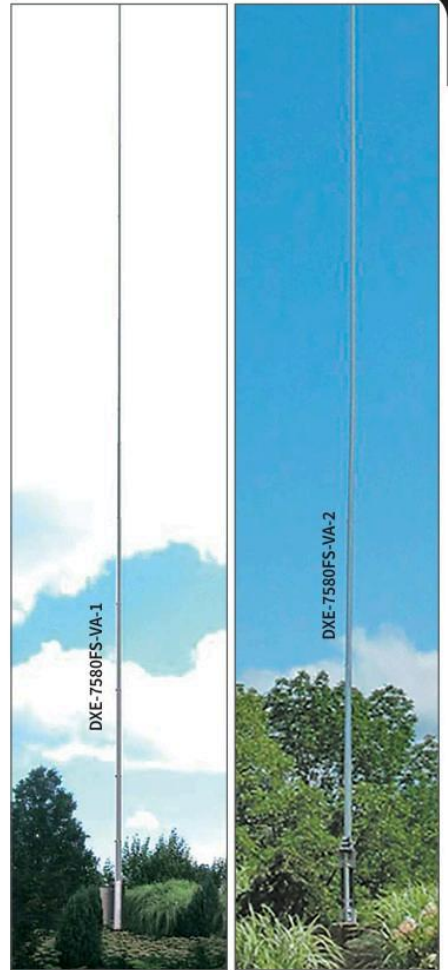

DX ENGINEERING

75/80 Meter Monoband Vertical Antennas

DX Engineering 7580FS Series are full size, quarter-wave high-performance antennas with everything you need in a high-performance vertical. They feature ultra-wide SWR bandwidth and unbeaten gain, and can handle the highest power amplifiers for reliable performance. They're ideally suited for single antenna applications and directional multi-antenna arrays. Visit DXEngineering.com for details.

DXE-7580FS-VA-1 has a 2" OD heavy wall base section. Its slim profile means you can hide it easily, even in a small stand of tall trees. Some DXers have painted the antenna to match the bark of the surrounding trees. Because of its slim, full size height, guying is required on this antenna.
DXE-7580FS-VA-1 2" OD Full Size Vertical.....**\$899.98**

DXE-7580FS-VA-2 has a 3" OD heavy wall base section and thick-wall 6061 aluminum tubing mid-sections, providing a strong antenna with **no guying necessary**. The antenna can easily be lowered with the supplied Heavy-Duty Plus Stainless Pivot Base and the optional DXE-VRW-1 hand winch.

DXE-7580FS-VA-2	3" OD Full Size Vertical.....	\$1,534.98
DXE-VRW-1	Manual Winch Add-On Kit	\$287.99

The massive DXE-7580FS-VA3 features a 4" OD heavy wall base section and thick-wall 6061 mid sections, creating a very stout 68 foot vertical antenna with **no guying necessary**, even in adverse conditions. It can be lowered easily with the supplied Heavy-Duty Plus Stainless Pivot Base and the optional DXE-VRW-1 hand winch.

DXE-7580FS-VA-3	4" OD Full Size Vertical.....	\$2,959.97
DXE-VRW-1	Manual Winch Add-On Kit	\$287.99

Our catalog is only the beginning! See thousands of products at DXEngineering.com

Multi-Band DX ENGINEERING

High Performance HF Vertical Antenna Systems Now with OMNI-TILT Option

DX Engineering's tech support teams have bundled together multi-band vertical antenna systems designed to get you on the HF bands quickly, without the component-matching hassles. The systems are based around a Hustler Multi-Band HF Vertical.

The DX Engineering team chose Hustler because of the antennas' performance, durability and versatility. The verticals are easy to tune and deliver outstanding performance.

The P3 combos also include DX Engineering's patented

Radial Plate, which creates an ultra-reliable radial system to ensure optimized antenna performance. The patented DX Engineering Tilt Base makes it easy to raise/lower the antennas for service, bad weather, or to keep the neighbors happy.

You'll also get appropriate stainless steel clamps, hardware, direct coax feedpoint kit, SecureMount™ connector kit, coax jumper and a 64 page installation guide. The P2 packages come with everything in the P3 combos but include the OMNI-TILT base instead of the Tilt Base. Exact contents vary by system, visit DXEngineering.com for complete package details.



DXE-HSR-6BTV-P2



DX ENGINEERING

OMNI-TILT™ Vertical Antenna Tilt Base Packages

Thanks to its all-new design features, the DX Engineering OMNI-TILT Vertical Antenna Tilt Base has become widely popular. So, we decided to make it even easier to install by creating vertical antenna packages that include both the base and a comprehensive hardware kit.

The OMNI-TILT Base was designed upon on the same proven-safe technology as the patented DX Engineering Saf-T-TILT™ Base and the patented DXE-TB-3P Tilt Base. The antenna can't fall when the fasteners are loosened. Lifting the OMNI-TILT base plate disengages the bolts from the top, so the antenna can be easily lowered for maintenance or to protect it from extreme weather.

It's custom made from laser cut 1/8" thick stainless steel for strength and durability. All of the hardware used in the OMNI-TILT Base is stainless steel to ensure long and dependable service. The DX Engineering OMNI-TILT base is compatible with a wide variety of vertical antennas—including homebrew verticals.

We make several OMNI-TILT optional mounting hardware kits available separately to expand and upgrade the base's versatility.

- DXE-OMNITILT-1P OMNI-TILT Package for Trap Verticals..... **\$105.98**
- DXE-OMNITILT-2P OMNI-TILT Package for Mast Mounted Verticals..... **\$163.97**
- DXE-OTMC-250P OMNI-TILT Mounting Clamp Kit **\$31.99**
- DXE-TVA-HWK Replacement Tilt Base Hardware Kit **\$5.99**
- DXE-AOK-OT1194 OMNI-TILT Wing Nut Knobs **\$11.99**

Note: OMNI-TILT shown with optional parts.

Band Coverage							
Multi-Band High Performance HF Vertical Antenna Systems with OMNI-TILT Base							
Part Number	80M	40M	30M	20M	15M	10M	Price
DXE-HSR-4BTV-P2		X		X	X	X	\$683.88
DXE-HSR-5BTV-P2	X	X		X	X	X	\$743.88
DXE-HSR-6BTV-P2	X	X	X	X	X	X	\$779.88
Multi-Band High Performance HF Vertical Antenna Systems with DXE-TB-3P Tilt Base							
Part Number	80M	40M	30M	20M	15M	10M	Price
DXE-HSR-4BTV-P3		X		X	X	X	\$630.89
DXE-HSR-5BTV-P3	X	X		X	X	X	\$690.89
DXE-HSR-6BTV-P3	X	X	X	X	X	X	\$726.89

BTV Verticals HUSTLER

The Hustler BTV antenna series delivers great performance, easy assembly, and the best reliability of any multi-band vertical on the market. These antennas offer 2:1 SWR or better at the band edges and up to a 100 kHz bandwidth on 75/80M (5BTV and 6BTV only). Hustler's exclusive trap design offers the lowest loss possible.

Hustler BTV series antennas are a quarter-wave-trapped vertical design that should be ground-mounted with radials or elevated-mounted with tuned radials. Visit DXEngineering.com for more information about radials for quarter-wave vertical antennas.

The sealed cover on the traps assures stable tuning in all kinds of weather. There is a wide tuning range designed in the antenna to accommodate differing ground plane conditions. All antenna sections use 1.25 inch heavy wall, high strength aluminum. The traps use a solid 1 inch fiberglass form for optimum electrical and mechanical stability. The base uses an extra heavy-duty aluminum mounting bracket with low loss, high strength insulators.

- HSR-4BTV BTV-4 Band Antenna Only..... **\$297.98**
- HSR-5BTV BTV-5 Band Antenna Only..... **\$357.98**
- HSR-6BTV BTV-6 Band Antenna Only..... **\$393.98**



HSR-5BTV

Service Parts for Hustler Verticals

DX Engineering now stocks a ton of parts to keep your Hustler Antenna on the air for a long time. These are genuine Hustler parts, so you're assured both excellent fit and function. Don't see a critical part you need? Call us, we may be able to special order it for you—or perhaps suggest a custom solution.

Part Number	Description	Price
HSR-TRAPCVR-P	Replacement Trap Caps, Set of 4	\$19.99
HSR-3772-1	Clutch Nut for Old-Style RM Resonators	\$3.00
HSR-3774-1	Clutch Sleeve for Old-Style RM Resonators	\$1.50
HSR-4087-1	Lower Aluminum Tube for BTV Series	\$29.99
HSR-4090-1	10 Meter Trap for BTV Series	\$42.99
HSR-4090-2	15 Meter Trap for BTV Series	\$42.99
HSR-4090-3	20 Meter Trap for BTV Series	\$42.99
HSR-4090-4	30 Meter Trap for BTV Series	\$42.99
HSR-4098-1	Antenna Base Assembly Bracket for BTV Series	\$54.99
HSR-4457-1	Spider Assembly for 5BTV Antenna, 3-Blade	\$11.99
HSR-9471	Spider Assembly for 4BTV and 5BTV, with Hardware and Tubing	\$23.99
HSR-49-04-40S	Antenna Whip for RM-40S Super Resonator	\$6.99
HSR-49-04-80S	Antenna Whip for RM-80S Super Resonator	\$10.99



Add-On Kits for Hustler BTV Verticals DX ENGINEERING

DX Engineering offers add-on kits that provide additional frequency band coverage or installation and operating convenience to the popular Hustler BTV vertical antenna family. Simply add the kit, make some minimal tuning adjustments, and you're on the air with an additional band. The AOKC-17M and DXE-AOKC-12M are upgraded versions of the original 17 and 12 meter add-on kits. The stainless steel DXE-AOK-DCF allows simple connection of coaxial cable with a PL-259 connector.

- DXE-AOKC-12M Upgraded 12 Meter Add-On Kit for Hustler BTV Verticals..... **\$95.99**
- DXE-AOKC-17M Upgraded 17 Meter Add-On Kit for Hustler BTV Verticals..... **\$115.99**
- HSR-30-MTK 30 Meter Add-On Kit for Hustler 4BTV and 5BTV Verticals..... **\$71.99**
- DXE-AOK-60M 60 Meter Add-On Kit for Hustler BTV Verticals **\$121.99**
- DXE-AOK-80M 80 Meter Add-On Kit for Hustler 4BTV Verticals **\$110.47**
- DXE-AOK-DCF Direct Coax Feed for Hustler BTV Verticals..... **\$42.99**
- DXE-8X19-RT Vertical Antenna Feedpoint Cable **\$47.99**

Guy Rings

You can use DX Engineering's finely engineered Guy Rings to secure your rope guys and stabilize your DX Engineering, Hustler or other aluminum vertical antenna. They're also great for our Telescoping Fiberglass and Aluminum Tubing Kits.



These guy rings are super strong, virtually impervious to the elements and fit 0.75", 1.0", 1.25", 1.50" and 2.0" OD tubing. For all the specs, please visit DXEngineering.com.

- DXE-GR-2P Guy Rings, Set of 2 **\$5.29**
- DXE-GR-4P Guy Rings, Set of 4 **\$10.29**
- DXE-GR-5P Guy Rings, Set of 5 **\$9.29**

We stock many more items than we can show. See them all at DXEngineering.com!

DX ENGINEERING

Tilt Base

No more climbing ladders or removing a bracket from the support post. One person can easily lift the antenna, tilt it to the side and walk it down. The optional DXE-AOK-TB1193 Wing Nut Kit makes for a no-tools fastening of the tilt base. Precision-cut from 3/16 inch 304 stainless steel, the Tilt Base is virtually indestructible and conveniently mounts to the same mast that you use for the antenna and radial plate. The Tilt Base is great for installations that need to accommodate CC&R, or for taking down antenna during severe weather.

Use DXE-TB-3P for Hustler® BTV models, DXE-TB-4P for specific Butternut®, GAP, Hy-Gain and DX Engineering Verticals, and use DXE-TB-6P for HyGain 14AVQ. The DXE-TB-4P Tilt Base is intended for quarter-wave verticals that have a minimum of 1/2 inch and a maximum of 2 inch OD base, weigh up to 20 pounds, and have a height of no more than 28'. Vertical antennas up to 43' must be adequately guyed, and extra precautions should be taken when raising or lowering the antenna to avoid undue lateral stress on the tilt mechanism. If you are mounting your Tilt Base to a ground mounted pipe, you will need two DXE-SSVC-2P V-Bolt Saddle Clamps to complete the installation.

DXE-TB-3P	Tilt Base Kit for Hustler BTV Model Antennas	\$83.99
DXE-TB-4P	Tilt Base Kit for Antennas Other Than Hustler BTV	\$129.46
DXE-TB-6P	Tilt Base Kit for Hy-Gain 14AVQ	\$122.48
DXE-TB-7P	Tilt Base for COMTEK 40VA and 30VA Verticals, Kit.....	\$134.98
DXE-TB-8P	Tilt Base for COMTEK 20VA Verticals.....	\$134.98
DXE-AOK-TB1193	Wing Nut No-Tools Kit, Pack of 2	\$11.99
DXE-SSVC-2P	V-Saddle Clamp, 1" to 2" OD Applications	\$16.49

Shown with optional parts



DX ENGINEERING

HF Antenna Mounting Heavy-Duty Pivot Base

You don't have to call a buddy—this base lets you raise your antenna without asking for help. It's perfect for both monoband and multi-band HF vertical antennas. In fact, this is the same base supplied with many of DX Engineering's vertical antenna kits, including the 55' models, 80/40 meter DXE-8040VA-1, and 160 meter DXE-160VA-1.

Made with stainless steel components and extra-strong Extren® insulated channels, the DX Engineering Pivot Base for 3" O.D. tubing is an excellent HF antenna mounting solution. Also choose the optional DXE-VRW-1 Manual Winch. Visit DXEngineering.com to see exact installation parameters.

DXE-VA-PIVOT-3	Pivot Base, for 3" O.D. Base Tubing	\$713.99
----------------	---	-----------------



Shown with optional parts.

DX ENGINEERING

Telescoping Aluminum Antenna Kit

- 65' Maximum Length
- Eleven telescoping sections from 2" to 7/8" OD
- Stainless steel element clamps

DXE-ATK65A	Telescoping Aluminum Antenna Kit	\$459.99
DXE-VE-BASE	Vertical Antenna Fixed Base Assembly, Insulated.....	\$116.99
DXE-VA-BASE	Vertical Antenna Tilt Base Assembly, Insulated.....	\$202.99

DXE-VA-BASE



DX ENGINEERING

Vertical Ground Mount Tubing

Made from high strength, galvanized 4130 chromoly steel, DX Engineering Vertical Ground Mount Tubing is a solid choice for installing and supporting large vertical antennas, tilt pivot bases, and other antenna and mast tilt mounts. Intended for placement in concrete foundations, this cold-drawn, electric-weld tubing has a yield stress rating of over 100,000 PSI, a minimum tensile strength above 110,000 PSI, 0.250" wall thickness, and cold galvanized ends to inhibit rust. Tubing is available in two lengths specifically made for vertical antenna ground-mount usage and at reasonable common ground shipping costs: 2" OD about 5' 4" long and 3" OD about 7' 3" long. Note: Shipped tubing may be slightly longer than indicated.

DXE-VGMT-2CG	Galvanized Steel Tubing, 2" OD about 5' 4" long	\$201.99
DXE-VGMT-3CG	Galvanized Steel Tubing, 3" OD about 7' 3" long	\$405.99



butternut

BUT-MPS



BUT-A-15



BUT-290-05A



BUT-GRK

BUT-TBR-160X

Vertical Antennas

Butternut Antennas have a well-earned reputation for performance and long life. They are easy to erect and tune, and will last many years. No lossy traps are used in these internationally acclaimed antenna designs.

BUT-HF9V	9-Band, 80/40/30/20/17/15/12/10/6M	\$959.99
BUT-HF6V	6-Band, 80/40/30/20/15/10M	\$839.99
BUT-HF2V	2-Band, 80/40M	\$659.99
BUT-MPS	Mounting Post Sleeve for HF6V/HF9V	\$53.99
BUT-GRK	Ground Radial Kit for HF2V/HF6V/HF9V	\$127.99
BUT-TBR-160X	Newly Designed 160M Add-On Kit for HF2V/6V/9V	\$249.99
BUT-A-17-12	17/12 Meter Kit for HF6V, 277-10	\$158.99
BUT-A-15	15M Resonator Kit for HF6V/9V	\$153.99
BUT-A-6	6 Meter Kit for HF6V, 277-12	\$106.99
BUT-290-06A	Replacement 67 pF Capacitor	\$54.99
BUT-290-05A	Replacement 200 pF Capacitor and Hardware Pack	\$55.99
BUT-290-07A	Replacement 67 pF and 200 pF Capacitor and Hardware Pack	\$104.99
BUT-290-08A	Replacement 75 Ohm Matching Cable with FPC, HF6V, HF9V	\$139.99
BUT-290-08B	Replacement 75 Ohm Matching Cable, HF6V, HF9V	\$95.99
BUT-290-08C	Feedpoint Connector, HF2V, HF6V, HF9V	\$63.99
BUT-290-11	Capacitor Bracket Replacement Kit, 80/40/17/12M	\$46.99
BUT-290-12	Tube B1 with Insulator	\$53.99
BUT-290-13	Replacement 30M Bracket and Capacitor Kit	\$119.99
BUT-290-14	Hardware Pack for HF2V	\$21.99
BUT-290-15	Hardware Pack for HF6V/HF9V	\$29.99
BUT-290-16	Insulator Replacement Kit for HF2V/HF6V/HF9V, Set of 2	\$36.99
BUT-290-17	Replacement Aluminum Tube B for HF6V, HF9V	\$41.99

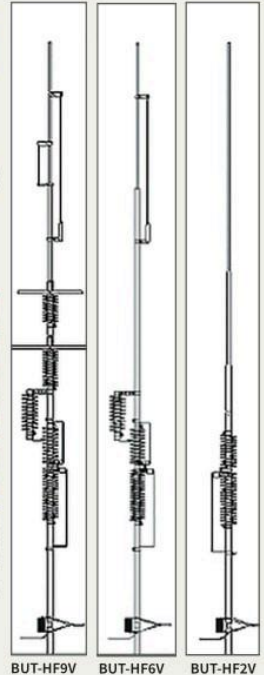

MOONRAKER

GPA-80 HF Vertical 80-6M Antennas

Available in either fiberglass or aluminum, these Moonraker antennas provide a cost-effective solution to start enjoying the fun of getting on HF. Power rated at 400W and standing at a stealthy 19.69', they feature an unun-matched base, VSWR of less than 1.5:1 over all bands and 50 Ω to the transceiver with a user-supplied wide impedance range external tuner. Antenna mount and clamps included. Not for use with internal radio tuner. Adding radials is highly recommended to maximize performance. External ATU required.

MKR-11-251	HF Vertical 80-6M Antenna, Aluminum	\$169.99
MKR-11-252	HF Vertical 80-6M Antenna, Fiberglass	\$199.99



DXEngineering.com is loaded with detailed photos, specs, videos, and more!

DX ENGINEERING

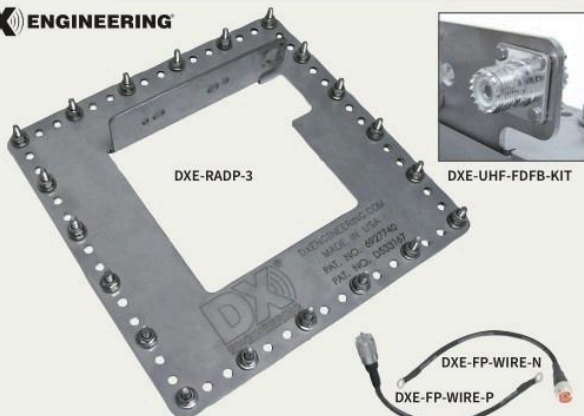

Radial Plate

DX Engineering's patented Radial Plate provides a neat, easy and effective way to connect essential radial wires and feedline to your quarter-wave vertical antenna. The plate can be attached easily and rigidly to a 4x4 or 6x6 post, steel or aluminum pipe up to 3 inches OD, a fence post, or whatever is supporting your antenna. Purchase the optional V-Saddle Clamp for mounting the plate to pipe up to 3 inches OD.

The plate assembly has been drilled for an optional SO-239 panel mount or bulkhead mount connector, available from DX Engineering. This will ground the shield of your feedline to the radial plate before it goes to the antenna, allowing maximum transfer of ground current directly into your radial system.

- Provides attachment for coaxial cable shield
- Square to allow most radial attachment points
- Stainless steel plate won't dissolve like aluminum
- Stainless steel hardware

DXE-RADP-3	Radial Plate with 20 Stainless Steel Bolt Sets.....	\$99.99
DXE-RADP-1HWK	Hardware Set, Includes 20 sets of 1/4" Stainless Hardware.....	\$11.59
DXE-225RT-20	Ring Terminals, 1/4" Hole, for 14-/16-Gauge Wire, 20 Pack.....	\$6.49
DXE-SSVC-2P	V-Saddle Clamp, 1" to 2" OD Applications.....	\$16.49
DXE-SSVC-3P	V-Saddle Clamp, 2.375" to 3" OD Applications.....	\$19.49
DXE-UHF-FDFB-KIT	SecureMount™ SO-239 Bulkhead Connector Kit.....	\$17.48
DXE-112-KIT	SO-239, PTFE/Silver, Chassis Mount with Hardware.....	\$16.99
DXE-363-SST	SO-239, PTFE/Silver, Bulkhead Fitting with Hardware.....	\$11.99
DXE-FP-WIRE-N	Feedpoint Assembly, N Connector, Use with DXE-1023.....	\$26.99
DXE-FP-WIRE-P	Feedpoint Assembly, PL-259, Use with DXE-UHF-FDFB-KIT....	\$27.99
PTX-81343	Anti-Seize Compound, 1 Oz. Squeeze Tube.....	\$3.09

DX ENGINEERING

Vertical Antenna Matching Network

Without a means of adjusting feedpoint impedance, achieving the best SWR on 160, 80 and 40 meters on some vertical antenna installations with excellent radial systems may be difficult. The Vertical Antenna Matching Network lets you tune a low impedance antenna to the minimum SWR in the user-selected portion of the band without affecting operation on the other, higher frequency bands (if applicable). This Vertical Antenna Shunt Matching Network can be used on resonant 160 meter Inverted-L and Tee-Top wire verticals. The #12 AWG coil wire is tin-nickel plated for high power handling, corrosion resistance, ease of soldering and long-term reliability, even outdoors.

DXE-VMN-1	Vertical Antenna Matching Network.....	\$105.99
-----------	--	-----------------



DX Engineering Coil Tap Clips

These silver-plated Coil Tap Clips provide adjustable attachment points to uninsulated coils including homebrew, Miniductor™ and Airdux™. They also are useful for making flying connections to uninsulated wire in non-RF applications without soldering or cutting. These clips will accommodate wire sizes from #20 to #10 AWG.

DXE-CLIP-P	Coil Tap Clips, Pack of 5.....	\$10.99
------------	--------------------------------	----------------



Wing Nut No-Tools Kit for DX Engineering Tilt Base

Use these wing nut knobs for tool-less quick release of the DX Engineering DXE-TB Tilt Bases—handy for lowering the antenna for tuning or daily stealth operation. Simply remove the existing hex nuts and thread on the wing nuts. The old hex nuts store on the tilt base for future use. Purchase two sets to allow tightening of the lower mounting hardware without tools and for extended periods of upright installation and use.

DXE-AOK-TB1193	Wing Nut No-Tools Knobs, Pack of 2.....	\$11.99
----------------	---	----------------



Radial Wire Kits

Bulk Radial Wire Kits

You should install as many radials as possible to achieve optimal performance with a ground-mounted vertical. These radial wire kits use #14 stranded insulated copper wire that is UV-resistant, hard to see, and the relaxed PVC insulation allows it to lie down easily without a preset helix.

DXE-RADW-500K	Radial Kit, 500', Ring Terminals, Wire Staples.....	\$136.47
DXE-RADW-500KBD	Radial Kit, 500', Ring Terminals, Biodegradable Staples.....	\$137.47
DXE-RADW-1000K	Radial Kit, 1,000', Ring Terminals, Wire Staples.....	\$258.95
DXE-RADW-1000KBD	Radial Kit, 1,000', Ring Terminals, Biodegradable Staples.....	\$260.95



Pre-Assembled Radial Wires

These packages of pre-cut 14-gauge radial wires include 1/4" Ring Terminals that are machine-terminated on one end for quick attachment to your radial plate.

DXE-RADW-20RT	20' Radial Wire, 20 Pack.....	\$229.99
DXE-RADW-32RT	32' Radial Wire, 20 Pack.....	\$345.99
DXE-RADW-65RT	65' Radial Wire, 20 Pack.....	\$379.99
DXE-RADW-120RT	120' Radial Wire, 10 Pack....	\$425.99

Pre-Cut Radial Kits

DX Engineering offers pre-cut radial wire kits for the 80, 40, 20, 15 and 10 meter bands, complete with wire connection hardware for elevated radial installations. Just strip the wire ends, crimp and solder. Each radial is slightly longer than a quarter-wave to allow tuning as necessary.

DXE-RADW-1K	Radial Wire Kit for 20, 15 and 10M.....	\$55.99
DXE-RADW-40MK	Radial Wire Kit for 40M.....	\$44.99
DXE-RADW-80MK	Radial Wire Kit for 80M.....	\$79.99



Tinned Copper Radial Kits

Featuring 16 AWG tinned solid copper wire, tinned crimp ring terminals, and biodegradable staples, these kits provide a cost-effective solution for wiring your high-count, full-size ground radial systems for high-efficiency single verticals and multiple-element arrays.

DXE-TCRW16-5CBD	500' Radial Wire, 40 Rings, 200 Staples.....	\$141.95
DXE-TCRW16-1KBD	1,000' Radial Wire, 80 Rings, 400 Staples.....	\$315.91
DXE-TCRW16-25CBD	2,500' Radial Wire, 120 Rings, 600 Staples.....	\$508.87
DXE-TCRW16-5KBD	5,000' Radial Wire, 160 Rings, 800 Staples.....	\$891.83

DX ENGINEERING

Radial Wire Staples

There is no need to bury your radials for performance. DX Engineering Radial Wire Staples are perfect for fastening radials on the ground below the grass to eliminate the risk of damaging your radials during lawn maintenance. The radials disappear into the lawn within weeks.



The low-cost metal staples have a biodegradable counterpart. The "BD" suffix indicates a pack of 3 inch biodegradable anchors made from recycled PLA (Polylactide Resin). Depending on weather conditions, they will degrade in a year or two. They are easily installed and will hold radial wires in place until lawn roots overtake them—and then the staples disappear. Ecologically friendly. Color of BD staples varies.

DXE-STPL-100BD	Radial Wire Biodegradable Staple, 3", 100 Pack.....	\$19.99
DXE-STPL-100P	Radial Wire Metal Staple, 6", 100 Pack.....	\$18.99
DXE-STPL-300P	Radial Wire Metal Staple, 6", 300 Pack.....	\$62.99

Guying Kits

Many locations experience winds that can be damaging to antennas, even at ground level. These kits provide four ground anchors and plenty of 260 pound, 3/32 inch diameter rope to provide the guying necessary to protect your vertical antenna. The black rope is UV-protected to last for years.



DXE-GUY100-KIT	BTV Guying Kit, 100' of Rope.....	\$47.75
DXE-GUY200-KIT	BTV Guying Kit, 200' of Rope.....	\$60.74
DXE-GUY400-KIT	Vertical Guying Kit, 400' of Rope.....	\$86.72
DXE-GUY1000-KIT	HD Vertical Guying Kit with 1,000' of Rope.....	\$109.75
DXE-EA15	Earth Anchor.....	\$8.69

Accessories for Vertical Antennas

DXE-SSVC-2P	V-Saddle Clamp, 1" to 2" OD.....	\$16.49
DXE-AOK-TB1193	Wing Nut Tilt Base Add-On Kit, 2 Per Pack.....	\$11.99
DXE-AOK-DCF	Direct Coax Feed.....	\$42.99
DXE-8XDX002	Low Power DCF Jumper Cable, 2'.....	\$38.49
DXE-400MAXDX003	High Power/Low Loss DCF Jumper Cable, 3'.....	\$40.99



DX Engineering carries equipment from more than 160 top manufacturers!

DXE-EA15



HF/VHF Vertical Antenna

This update of Comet's popular CHA-250B makes a great choice if you'd like wide coverage but don't have a lot of real estate. Measuring 23.42' and weighing slightly over 7 pounds, the low-profile CHA-250HD boasts a power rating of 250W, easy assembly and setup, no ground radials, no tuning or adjustments, and SWR under 1.6:1 from 3.5 MHz-57 MHz. It also delivers excellent performance on the shortwave bands. Upgrades over the CHA-250B include a new solid whip that replaces the top aluminum section for greater strength in high winds (it has a 67.5 MPH wind survival rating) and improvements to its transformer matching section.

CMA-CHA-250HD HF/VHF Vertical Antenna..... **\$429.99**



Cushcraft

Amateur Radio Antennas

Vertical Antennas

R8 40-6 Meter 8-Band, 28.5' Vertical Antenna

This multi-band design provides 8-band coverage encompassing the 40, 30, 20, 17, 15, 12, 10 and 6 meter bands. The antenna provides 360 degree (omni) coverage on the horizon and a low radiation angle in the vertical plane for a better DX.

CSH-R8 8-Band Vertical Antenna..... **\$699.95**
 CSH-R8GK 3-Point, Non-Conductive Guy System for R8 **\$99.95**



R9 Nine-Band Vertical Antenna

Covering the 80-6 meter bands, the R9 is a versatile and efficient multi-band resonant design. It is 28.5 feet tall, handles full legal limit power (PEP) and requires no radials. See DXEngineering.com for more details.

CSH-R9 R9 Nine-Band Vertical Antenna .. **\$799.95**

Cushcraft Vertical Antennas

- CSH-AR10 10 Meter Ringo, 3 dB, 17.6' **\$179.95**
- CSH-AR6 6 Meter FM Ringo, 3 dB, 10' **\$159.95**
- CSH-AR2 2 Meter FM Ringo, 3 dB, 3.9' **\$109.95**
- CSH-ARX2 2 Meter Ringo Ranger, 5 dB, 12.5' **\$129.95**
- CSH-ARX2B 2 Meter Ringo Ranger II, 7 dB, 14' **\$179.95**
- CSH-ARX220B 220 MHz Ringo Ranger II, 7 dB, 9' **\$179.95**
- CSH-AR270 2 Meter/440 MHz Ringo, 3/5.5 dB, 3.75' **\$179.95**
- CSH-AR270B 2 Meter/440 MHz Ringo, 5.5/7.5 dB, 7.7' **\$259.95**

hy-gain

Patriot Vertical Antennas

Take advantage of the sunspot cycle with the low takeoff angle of Hy-Gain's Patriot Vertical Antennas. These three antennas feature efficient end-loading coils and capacity hats to give you optimum performance on several bands. They handle 1,500 watts, feature automatic band switching and each band is individually tunable. Their sleek, radial-less design means a low wind surface area and small footprint, so you can mount them easily on your deck, roof or patio. Discover the complete specs on each antenna at DXEngineering.com.

- HGN-AV-620 20, 17, 15, 12, 10 and 6 Meter Vertical, 22.5' **\$599.95**
- HGN-AV-640 40, 30, 20, 17, 15, 12, 10 and 6 Meter Vertical, 25.8' **\$659.95**
- HGN-AV-680 80, 40, 30, 20, 17, 15, 12, 10 and 6 Meter Vertical, 26' **\$769.95**



Super Penetrator 12/10 Meter Vertical Antenna



The legend from the 1970s is back! This fantastic, true full-size 5/8-wave vertical antenna from Hy-Gain is the only antenna of its type to survive the test of time.

Be ready for 10 meter activity at any time! This antenna will help you to collect more 10-10 numbers, work more DX and make Ham radio more fun.

The SPT-500 is 22 feet, 9.5" tall and is specifically designed to accept AM/FM, SSB, CW and digital signals with low loss. It handles 1,500 watts.

HGN-SPT-500 12/10M Vertical Antenna **\$259.95**



DX COMMANDER



DXC-SIGNATURE-9



DXC-SIGNATURE-18



DXC-RAPIDE2

HF Vertical Antenna Packages

DX Engineering is pleased to be the exclusive North American distributor of DX Commander's lineup of innovative, high-performance vertical antennas designed by Callum, M0MCX and ruggedly constructed in England's Midlands region for stations around the globe, including highly successful DXpedition setups. DX Commander multiband antennas boast efficient resonance on every band of operation; low SWR without the need for traps, coils, or antenna tuners; low takeoff angle; and a power rating of 1,500W SSB/CW and 400W for FT8 and other digital modes. The company's extensively tested antennas—from the freestanding Signature 9 model to the Rapide, made for quick deployment in the field—are based on the same principles as a fan dipole, with several vertical wire elements of various resonant lengths connected to a common feedpoint. Easy to construct and made for long-term use, antenna packages include sturdy fiberglass telescopic mast, stainless fasteners, aluminum ground and driven plates, spreader plates, EzyClamp stay-up kit, antenna wire, guying rope, and shock-cord. **Enter "DXC Commander" at DXEngineering.com for more details.**



DXC-EXPEDITION



DXC-SIGNATURE

- DXC-CLASSIC2 Classic Model, 40-2M, 32.81' **\$349.00**
- DXC-CLASSIC2-80 Classic Model, 40-2M Plus 80M, 32.81' **\$420.00**
- DXC-EXPEDITION Expedition Model, 40-6M, 36.75' **\$349.00**
- DXC-RAPIDE2 Rapide Model, 40-6M, 23' **\$299.00**
- DXC-SIGNATURE-12 Signature 12 Model, 80-6M, 40.68' **\$649.00**
- DXC-SIGNATURE-18 Signature 18 Model, 80-6M, 59' **\$799.00**
- DXC-SIGNATURE-9 Signature 9 Model, 40-10M (80M with horizontal Inverted-L wire), 29.53' **\$499.00**

Replacement Antenna Wire

A spool of DX Commander DX10 328' (100M) antenna wire provides enough wire to replace the elements on all DX Commander antenna models while still having enough left over to use for making radials. Approximately 19 AWG, this UK military-spec PVC-insulated stranded copper wire offers strength and flexibility.

DXC-DX10WIRE DX10 Replacement Antenna Wire, 328' Spool **\$71.00**

EzyClamp Replacement Mast Clamp Kits

These clamp kits are direct replacements for the mast clamps originally supplied with DX Commander telescoping masts. Constructed from durable Nylon 66, the clamp kits are available for all antenna models above. **Enter "DXC Hex Clamp" at DXEngineering.com for more details. Pricing from \$7.49 to \$23.99.**



Check out our YouTube channel for in-depth tech tips and product demos!



Dual Vertical Array Systems

The Dual Vertical Array is an easy-to-install two-element vertical antenna phasing system that offers great HF performance. It uses a new design to increase array efficiency by eliminating the wasteful dump port found on previous systems. These monoband vertical array phasing relay units handle up to 2kW and develop cardioid patterns with over 20 dB front-to-back and up to 3 dB gain over a single vertical.

The Control Console is a 3-direction pattern selector that uses LEDs as directional indicators. The console requires 13.8 Vdc and uses 3-conductor 20 AWG control line. The EC-DVA is included with the Dual Vertical Array Systems and also available separately if you'd like to build your own custom control system. Requires two ground-mounted monoband quarter-wave verticals and radial systems, sold separately.

The DX Engineering Dual Vertical Array Systems are available for the Amateur Radio bands below. Enter "DXE Dual Vertical" at DXEngineering.com for more details.

DXE-DVA-160B-P	Dual Vertical Array System, 160M.....	\$581.98
DXE-DVA-80B-P	Dual Vertical Array System, 80M.....	\$575.98
DXE-DVA-40B-P	Dual Vertical Array System, 40M.....	\$575.98
DXE-EC-DVA	Control Console.....	\$165.99

Other packages available for 60M, 30M, 20M, 17M, 15M, 12M and 10M..... from **\$575.98**
By special order. See DXEngineering.com and enter "DXE Dual Vertical" for details.

Quarter Wavelength 80M and 40M Tuned Phasing Cable Assemblies
These assemblies feature reliable DX Engineering RG-11/U 75 Ω cable with PL-259 connectors. For use on Four-Square Arrays, Dual Vertical Arrays and other systems.

DXE-QW11-3650	Phasing Cable Assembly, 80M, Tuned 3.650 MHz, Each.....	\$139.99
DXE-QW11-3650-2P	Phasing Cable Assembly, 80M, Tuned 3.650 MHz, Set of 2....	\$279.98
DXE-QW11-3650-4P	Phasing Cable Assembly, 80M, Tuned 3.650 MHz, Set of 4....	\$559.96
DXE-QW11-7100	Phasing Cable Assembly, 40M, Tuned 7.100 MHz, Each.....	\$99.99
DXE-QW11-7100-2P	Phasing Cable Assembly, 40M, Tuned 7.100 MHz, Set of 2....	\$199.98
DXE-QW11-7100-4P	Phasing Cable Assembly, 40M, Tuned 7.100 MHz, Set of 4....	\$399.96

ACB-4 Hybrid Four-Square Systems for 4-Element Vertical Arrays

COMTEK uses a time tested design to produce advanced antenna systems. These Four-Square Array Systems are affordable, simple to install, and easy to use. A Four-Square array consists of four vertical elements fed in a phase relationship and power ratio to obtain a directional pattern. COMTEK vertical arrays provide great directivity. We offer the ACB-4 Hybrid Four-Square System for each Amateur band from 160 meters to 10 meters. The system is band specific. For example, you cannot use an 80 meter ACB-4 Hybrid Four-Square System for any band other than 80 meters.

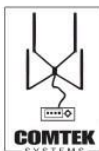

90 Degree Hybrid-Relay Unit

- 2 kW rating for Amateur SSB and CW
- 15 amp gold plated contact relays with dust covers
- Balanced temperature, frequency, and voltage stable capacitors
- PTFE silver stranded wire over fiberglass tape-wound toroids
- Double-sided printed circuit board
- MOVs for lightning surge protection with RF bypass caps
- Brushed aluminum Z-chassis and cover with riveted seams
- Includes mounting clamp

Switch Control

- Custom USA-made switch
- Current limiting resistor protection for each LED
- Chassis and cover custom manufactured to COMTEK specifications
- Label for recording favored directions
- Compact size: 2" H x 6.25" W x 5" D



COM-ACB-20-A

COM-ACB-160-A	Hybrid Phased Array Four-Square System, 160M.....	\$579.98
COM-ACB-80-A	Hybrid Phased Array Four-Square System, 80M.....	\$569.98
COM-ACB-40-A	Hybrid Phased Array Four-Square System, 40M.....	\$599.98
COM-ACB-30-A	Hybrid Phased Array Four-Square System, 30M.....	\$709.98
COM-ACB-20-A	Hybrid Phased Array Four-Square System, 20M.....	\$709.98
COM-ACB4A	ACB-4A Series Four-Square Control Console.....	\$169.99



Transmit Four-Square Hybrid Controller—4 Directions plus Omni

DX Engineering TFS4 Series B Transmit Four-Square Systems bring together the highest level of engineering excellence with the practical realities of operator convenience and ease of installation. They're available for the 160, 80 and 40 meter bands, and can be easily dropped-in to your quarter-wave spaced vertical 4-antenna array for optimum directional control.

The systems allow you to receive or transmit with 5.5 dB gain in any one of four directions with a 20+ dB front-to-back ratio for interference reduction from unwanted directions. You can also switch to a single omni-directional pattern with a push of a button. That means you'll be able to listen "all-around," unhindered by pattern nulls, and then select the best direction for signal reception and noise rejection.

The TFS4 Series B Transmit Four-Square Systems are designed for use with a four monoband vertical antennas spaced at the corners of a square that are a one quarter wavelength on a side. The vertical antennas must be ungrounded and resonant in the desired band, and should be directly base-fed by the coaxial cable phasing lines from the centrally located controller. DX Engineering has vertical antennas that are well suited for this application. A properly designed and installed radial system is necessary for top antenna performance.

We recommend our optional Q75-series quarter wavelength cables. They're electronically pruned to a precise electrical length tailored to your operating frequency. The cables are terminated with hand-soldered silver-PTFE PL-259 connectors and weather-sealed with shrinkable tubing. Finally, each cable is tested for high voltage breakdown for maximum reliability and power handling. Since the transmit power is divided by the controller, the coaxial cable can handle maximum power with ease.

If you already have a four-square array with a hybrid controller and would like improved performance and add the omni feature, the DX Engineering TFS4 Series B Transmit Four-Square Systems are a simple upgrade. BCD logic switching allows for the use of a 4-wire control cable to perform the necessary switching functions when powered by the included DXE-CC-4SQR control console.

- Classic Hybrid design for easy installation
- 5 kW CW power rating for high reliability
- Hot switching lock-out feature disables amplifier while switching
- Simple upgrade for COMTEK SYSTEMS four-square array
- Proven high performance DX Engineering RF relays
- RF shielded, high impact thermoplastic cover offers unique protection
- Relays cycle during power-on to ensure clean contacts

DXE-TFS4-160B-P	160 Meter Four-Square Controller with Control Console.....	\$831.98
DXE-TFS4-80B-P	80 Meter Four-Square Controller with Control Console.....	\$811.98
DXE-TFS4-40B-P	40 Meter Four-Square Controller with Control Console.....	\$807.98

The Control Console is also available separately.

DXE-CC-4SQR	Transmit Four-Square Control Console.....	\$251.99
-------------	---	-----------------

DX Engineering Customer Support personnel will be happy to help you select all the components necessary for a complete installation.



Hybrid Array Cables & Accessories

DXE-Q75-160-4	Hybrid Array Cable, 160M, DXE-11U, PL-259 Connectors.....	\$645.13
DXE-Q75-80-4	Hybrid Array Cable, 80M, DXE-11U, PL-259 Connectors.....	\$478.58
DXE-Q75-40-4	Hybrid Array Cable, 40M, DXE-11U, PL-259 Connectors.....	\$378.22
DXE-Q75-30-4	Hybrid Array Cable, 30M, DXE-11U, PL-259 Connectors.....	\$348.00
DXE-Q75-20-4	Hybrid Array Cable, 20M, DXE-11U, PL-259 Connectors.....	\$330.56
DXE-Q75-15-4	Hybrid Array Cable, 15M, DXE-11U, PL-259 Connectors.....	\$314.67
DXE-Q75-10-4	Hybrid Array Cable, 10M, DXE-11U, PL-259 Connectors.....	\$306.71
COM-CW3	Control Cable, 3-20 AWG Wires, Black PVC Jacket.....per foot	\$0.49
COM-CW3-1000	COM-CW3 Control Cable, 1,000' Spool.....	\$279.99
COM-CW4	Cable, 4-Conductor.....per foot	\$0.85
COM-CW4-500	Cable, 4-Conductor, 500' Spool.....	\$237.99
COM-VFA-1	Vertical Feedpoint Assembly.....	\$19.99
COM-VFA-4	Vertical Feedpoint Assembly, Set of 4.....	\$79.96
DXE-RADP-3	Stainless Steel Radial Plate with 20 Bolt Sets.....	\$99.99
DXE-SVSC-2P	V-Saddle Clamp, Fits 1" to 2" Tube.....	\$16.49

For new hams, check out our Getting Started HT, Mobile, and Base Radio Packages!

DX ENGINEERING

DXE-PS-2B PRO-STACK Broadband Two Antenna Phasing System

The PS-2B PRO-STACK combines two identical Yagi, log periodic or vertical antennas in a phased arrangement. It is a broadband system that operates from 160 through 10 meters with no need for coaxial delay lines. The PS-2B can be used in applications requiring these four basic antenna feed selections (impedance matching automatically changes when any antenna port is disconnected).

- Both antenna ports in-phase (default)
- Both antenna ports out-of-phase
- Antenna port 1 only
- Antenna port 2 only

DXE-PS-2B-P



Additional Applications

- **Scalable Multi-Antenna Systems**—The PS-2B easily adapts to larger arrays. For example, four stacked Yagis can be combined by creating two sets of two and using a third PS-2B to combine the first two sets.
- **Phased Verticals**—The system can feed three vertical antennas in a four-pattern array. In this arrangement, the three antennas are individual quarter-wave resonant antennas. The center #2 passive element must be directly grounded at all times. Elements #1 and #3 are then fed in various phase relationships.

Additional Features

- 50 Ω system—switched by applying 12-15 volts DC to three control wires
- Power handling up to 5 kW
- High-impact RF-shielded cover
- High RF-tolerant, silver-PTFE UHF connectors
- Proven high-performance DX Engineering RF Relays
- Safe 12-volt relay operation
- MOV surge protection on control lines
- RoHS-compliant

DXE-PS-2B	PRO-STACK Antenna Switch	\$599.99
DXE-PS-2B-P	PRO-STACK Antenna Switch and Control Console.....	\$795.98

The Control Console is also available separately.

DXE-EC-PS2	PRO-STACK Control Console.....	\$195.99
------------	--------------------------------	----------

Note: Information on the appropriate separation between stacked Yagi antennas in versatile, high-performance array is discussed fully in the ARRL Antenna Book. Generally, stacked Yagi antennas are separated vertically by greater than 1/2-wavelength free space.



DXE-PS-3BDIN-P

DX ENGINEERING

PRO-STACK Three Antenna Phasing Systems

DX Engineering's PRO-STACK phasing systems allow you to combine identical Yagi, Log Periodic Beam or quarter-wave vertical for enhanced performance. The systems promote broadband coverage of the 160-10M bands in a dozen in- and out-of-phase antenna configurations. This system provides impressive nulls (up to 40 dB!), so you can ward off unwanted signals and snag that rarest-of-rare QSO. The system consists of a relay unit and control console; each component is also available separately. PRO-STACK systems will easily handle the full legal limit and are powered by any 12 Vdc source. Nine-conductor control cable is required for operation. Choose your system based on the connector type you prefer: 7-16 DIN, SO-239, or type N. Use keywords "PRO-STACK" at DXEngineering.com for the details.

DXE-PS-3B-P	PRO-STACK Three Antenna Phasing System, SO-239 Connectors.....	\$1,105.98
DXE-PS-3BDIN-P	PRO-STACK Three Antenna Phasing System, 7-16 DIN Connectors.....	\$1,101.98



Check out our blog, OnAllBands.com, for articles on upcoming DXpeditions, what's new in contesting, digital operations, and a range of other topics.

Want more? We've got loads of tech videos and interviews on the DX Engineering YouTube channel. Of course, when you want personal attention, our experts are only an email or phone call away.

DX ENGINEERING

Skyhawk™ and Skylark Antennas.

The legendary Skyhawk and Skylark antennas have been mainstays of international DXers and distinguished HF contesters for years. Both antennas have been brought under the DX Engineering manufacturing umbrella. That means these highly regarded antennas are built to DX Engineering's unflinching quality standards. DX Engineering also carries all of the service parts you'll need to keep these antennas operating efficiently.



DXE-3X10

Skyhawk™ Yagi Antenna

With over 7 dB gain on the 20 and 15 meter bands, plus over 9 dB on the 10 meter band, the DX Engineering Skyhawk has become the choice of experienced HF DXers. A trap-free design ensures the best bandwidth possible. The use of aluminum and stainless steel hardware keeps the antenna's overall weight down to around 75 pounds. The Skyhawk has a 23 foot boom. It is easy to build and tune, and comes with a 2,500 watt feedpoint choke.

DXE-3X10	Skyhawk Yagi Antenna	\$2,350.97
----------	----------------------------	------------



DXE-2X7

Skylark™ Dual-Band Yagi

You get almost 8 dB gain on the 17 and 12 meter bands with the DX Engineering Skylark. The antenna also provides an SWR under 1.3 to 1 across each band, plus a front-to-back over 20 dB. It handles the legal limit plus! The Skylark's simple design eliminates any moving parts, which contributes to all-weather reliability. Aluminum elements and stainless steel hardware also promote corrosion resistance. With a boom length of just 16 feet, the Skylark can handle winds up to 90 mph. A feedpoint choke is included.

DXE-2X7	Skylark Dual-Band Yagi	\$1,709.99
---------	------------------------------	------------



DBO-OB11-5-P



DBO-OB4030-P



DBO-OB12-5-P



DBO-OB10-5M-P

OptiBeam 5-Band Yagi

This 20/17/15/12/10 meter, 10-element Moxon Yagi delivers the same elite-class performance enthusiasts have come to expect from OptiBeam's extensively tested and computer-optimized antennas. Weighing only 49.5 lbs., it features a 12.47' boom, 3,000W power rating and wind area of 8-9 square feet. System package includes balun, shipped separately.

DBO-OB10-5M-P 20/17/15/12/10 Meter Moxon Yagi **\$1,899.98**

The Big Bang.

Our Amateur Radio universe is expanding faster than ever with, with advances in digital modes and IP-based communications. Bookmark DXEngineering.com and make sure you don't miss a thing.

OptiBeam HF Directional Antenna Systems

DX Engineering carries the full lineup of world-famous OptiBeam HF directional antennas, built by Hams for Amateur Radio enthusiasts who demand lasting quality and proven performance. Available rotary dipole, Yagi and log cell Yagi antennas cover an impressive range of configurations and band coverages. If you're looking to give your station an optimal DXing and Contesting advantage, an OptiBeam antenna makes a sound choice and a wise long-term investment. All antenna systems come with a high-power 1:1 or 1:2 balun with a UHF female connector for your 50-ohm coaxial cable. DX Engineering "P" part numbers indicate balun included. Balun ships separately.

System Part Number	Description	Band(s)	Elements	Length	Price
DBO-OB1-80PLUS-P	Rotary Dipole	80 SSB-CW	1 End-Loaded	57.74'	\$3,099.98
DBO-OB1-40-P	Rotary Dipole	40	Single	48.23'	\$905.98
DBO-OB1-4030-P	Rotary Dipole	40/30	Single/Split	48.23'	\$1,169.98
DBO-OB1-30-P	Rotary Dipole	30	Single	30.32'	\$802.98

Part Number	Description	Band(s)	Elements	Boom Length	Price
DBO-OB10-3W-P	Yagi	20/17/15	10	19.23'	\$2,319.98
DBO-OB11-3-P	Yagi	20/15/10	11	20'	\$1,965.98
DBO-OB11-5-P	Yagi	20/17/15/12/10	11	19.69'	\$2,959.98
DBO-OB1210-P	Yagi	12/10	7	33.14'	\$2,679.98
DBO-OB12-4-P	Yagi	40/20/15/10	12	24.93'	\$3,759.98
DBO-OB12-4W-P	Yagi	40/20/17/15	12	26.57'	\$4,159.98
DBO-OB12-6-P	Yagi	40/20/17/15/12/10	12	20.01'	\$3,739.98
DBO-OB13-6-P	Yagi	40/20/17/15/12/10	13	25.92'	\$4,589.98
DBO-OB1510-P	Yagi	15/10	10	45.60'	\$3,499.97
DBO-OB15-7-P	Yagi	40/30/20/17/15/12/10	15	21.98'	\$4,559.98
DBO-OB16-3HD-P	Yagi	20/15/10	16	33.14'	\$3,019.98
DBO-OB16-5-P	Yagi	20/17/15/12/10	16	33.14'	\$4,189.98
DBO-OB17-4-P	Yagi	40/20/15/10	17	39.04'	\$5,359.98
DBO-OB18-6-P	Yagi	40/20/17/15/12/10	18	39.04'	\$6,359.98
DBO-OB21-3-P	Yagi	20/15/10	21	46.26'	\$3,899.98
DBO-OB2-30-P	Yagi	30	2	11.81'	\$2,059.98
DBO-OB2-40-P	Yagi	40	2	18.37'	\$2,259.98
DBO-OB2-40M-P	Moxon Yagi	40	2	18.37'	\$2,459.98
DBO-OB3-30-P	Yagi	30	3	29.20'	\$2,899.98
DBO-OB3-40-P	Yagi	40	3	29.53'	\$3,799.98
DBO-OB3-80PLUS-P	Yagi	80	3	65.62'	\$11,199.98
DBO-OB4020-P	Yagi	40/20	8	49.54'	\$5,959.97
DBO-OB4020X-P	Yagi	40/20	8	49.21'	\$7,359.97
DBO-OB4020SS-P	Yagi	40/20	5	22.97'	\$4,059.98
DBO-OB4030-P	Yagi	40/30	4	18.37'	\$3,599.98
DBO-OB4030X-P	Yagi	40/30	6	32.81'	\$5,199.98
DBO-OB4-20OWA-P	Yagi	20	4	24.61'	\$1,619.98
DBO-OB4-40-P	Yagi	40	4	39.04'	\$4,519.98
DBO-OB4-40OWA-P	Yagi	40	4	49.21'	\$6,759.98
DBO-OB5-10-P	Yagi	10	5	24.61'	\$1,389.98
DBO-OB5-12-P	Yagi	12	5	28.87'	\$1,819.98
DBO-OB5-15-P	Yagi	15	5	33.14'	\$2,489.98
DBO-OB5-17-P	Yagi	17	5	39.63'	\$2,619.98
DBO-OB5-20-P	Yagi	20	5	49.54'	\$3,259.98
DBO-OB6-10-P	Yagi	10	6	37.07'	\$1,859.98
DBO-OB6-15-P	Yagi	15	6	49.21'	\$2,519.98
DBO-OB6-2W-P	Yagi	12/10	6	14.57'	\$989.98
DBO-OB6-3M-P	Moxon Yagi	20/15/10	6	10.17'	\$1,299.98
DBO-OB7-3-P	Yagi	20/15/10	6	13.45'	\$1,359.98
DBO-OB9-5HD-P	Yagi	20/17/15/12/10	9	16.73'	\$1,925.98
DBO-OBLY11-4-P	Log Yagi	17/15/12/10	11	16.50'	\$1,659.98
DBO-OBLY14-4-P	Log Yagi	17/15/12/10	14	24.61'	\$2,259.98
DBO-OBLY16-5-P	Log Yagi	20/17/15/12/10	16	33.14'	\$3,099.98
DBO-OBLY20-5-P	Log Yagi	20/17/15/12/10	20	49.21'	\$4,529.98
DBO-OBLY25-5-P	Log Yagi	20/17/15/12/10	25	68.90'	\$5,759.98

New HF Directional Antenna Models from OptiBeam

Three new models are 20M Reflector-Driven Yagis (4-, 5-, or 6-element) developed in cooperation with OptiBeam consulting engineer Dr. Christian Römer, DF4IAR. This revolutionary version of an Optimized Wideband Antenna (OWA) uses specially connected and cross-phased driven and reflector elements to produce a Yagi with higher gains, higher front-to-back ratio, and very low SWR, all on the same boom length as the original OWA. Two other new models are Driven Yagi Arrays (DYA), featuring a special multi-element feed system that delivers exceptional multi-band performance.

DBO-OB4-20R-P	Reflector-Driven Yagi, 20M, 4 Element, 24.61' Boom.....	\$1,759.98
DBO-OB5-20R-P	Reflector-Driven Yagi, 20M, 5 Element, 39.38' Boom.....	\$2,419.99
DBO-OB6-20R-P	Reflector-Driven Yagi, 20M, 6 Element, 55.45' Boom.....	\$3,659.99
DBO-OBDYA9-4-P	DYA, 17/15/12/10M, 9 Element, 16.73' Boom.....	\$1,689.98
DBO-OBDYA12-5-P	DYA, 20/17/15/12/10M, 12 Element, 24.61' Boom.....	\$2,459.98

Most in-stock parts ship throughout the contiguous US in just 1-2 days!



OptiBeam VHF Antennas

OptiBeam's classic Yagis for the 6 meter band combine pure performance, strength and visual appeal to deliver the ultimate VHF beam for your station. As with all OptiBeam directional antennas, you can take advantage of these exclusives: specially configured, stable and properly shaped element holders; robust square and round booms with finely constructed element transitions; and perfectly aligned elements secured against torsion with minimal sag for a stellar look. All OptiBeam antennas are solidly built with high quality aluminum alloys, UV stable synthetic parts, and stainless steel hardware.

- DBO-OB6-6-P 6 Meter, 6 Elements, 20.14' Boom Length, w/Balun **\$859.98**
- DBO-OB5-6-P 6 Meter, 5 Elements, 14.57' Boom Length, w/Balun **\$739.98**

DX Engineering "P" part numbers indicate balun included. Balun ships separately.

hy-gain

Tri-Band HF Beam Antennas

If you want to get active on the 20, 15 and 10 meter bands, Hy-Gain's TH series antennas are an excellent choice. These durable antennas offer excellent gain in an efficient package. You can select the right-sized antenna for your specific installation, whether it's on a rooftop or a tower. These lightweight, multi-element Yagis also feature aluminum tubing for reduced stress on your rotator. Visit DXEngineering.com for the complete specs.



- HGN-TH-3JRS Tri-Band Yagi, 3-Element, 600 W, 8 dBi Gain..... **\$539.95**
- HGN-TH-3MK4 Tri-Band Yagi, 3-Element, 1,500 W, 8 dBi Gain..... **\$869.95**
- HGN-TH-5MK2 Tri-Band Yagi, 5-Element, 1,500 W, 9 dBi Gain..... **\$1,299.95**
- HGN-TH-7DX Tri-Band Yagi, 7-Element, 1,500 W, 9.6 dBi Gain..... **\$1,599.95**



Log Periodic Antenna

Designed for the serious operator who wants the best, this professional-grade LPDA antenna is tailored to the 20, 17, 15, 12 and 10 meter bands. If you have exact demands for your antenna, there is simply no better option than the Telrex. It has 16 elements on a 42 foot boom, handles 5,000W and weighs 350 pounds. With 7.5 dBi gain and a bandwidth of 16 MHz at 2:1 SWR, this antenna is an excellent performer—even for commercial and industrial installations. This Log Periodic Antenna is built on demand. Get complete antenna specifications at DXEngineering.com.

- TEL-143042-135 Log Periodic Dipole Array Antenna **\$10,000.00**



DXE-XB-5 Hexx Beam

The all-new DX Engineering DXE-XB-5 Hexx Beam is a lightweight directional HF antenna for permanent installations or temporary operations on 20, 17, 15, 12 and 10 meters. Full legal power handling and high performance is achieved with full-size pre-cut wire elements, our patented* balanced feeder system, and a new 1:1 balun with mount included. Specialized hardware, a new mast plate, better fiberglass, and simplified assembly make the new XB-5 model DX Engineering's best Hexx Beam ever.

- Easier assembly with fewer parts
- Balun and mount included
- Heavy-duty mast plate
- Stronger fiberglass without slits
- Pre-sized and pre-drilled element spacer insulators
- Simple tuning adjustment (if needed)
- Improved SWR band coverage
- Pre-made heavy duty "ice" support ropes with thimbles and stainless steel carabiners

In memoriam of Steve Hunt, G3TXQ (SK), who pioneered the broadband Hexbeam design, the new XB-5 Hexx Beam builds on the success of the Mark II version perfected by DX Engineering over a decade ago. The XB-5 Hexx Beam now has simplified spacers for the full-length wire elements with no losses, improved SWR bandwidth and great front-to-back performance. The fully illustrated manual makes installation easy. Enjoy extraordinary receive capabilities and work more stations with the XB-5. ***US Patent No. 8,669,911 and D624,060 and British Patent Number GB248003 B.**

- DXE-XB-5 5-Band HF Hexx Beam Antenna..... **\$1,226.92**

InnovAntennas.com

10M and 6M Yagis

Designed by InnovAntennas' founder, Justin, G0KSC, the robust 10M & 6M Yagis deliver excellent gain and sturdy, reliable performance even in adverse weather conditions. Fed by a single coaxial cable, these antennas are constructed from two independent and nested Yagi systems, allowing them to have a compact size and a relatively short boom. Both antenna systems use a common antenna cable, avoiding the interference that can result when multiple feed lines are employed. Models are available with 6, 8, 9, 11, and 13 elements. Stainless steel hardware included.



- IVA-18485-1061 10M and 6M Yagi, 3+3 Interlaced Elements, 8.2' Boom..... **\$535.99**
- IVA-18485-1060 10M and 6M Yagi, 4+4 Interlaced Elements, 12.1' Boom..... **\$739.99**
- IVA-18485-1062 10M and 6M Yagi, 4+5 Interlaced Elements, 13.8' Boom..... **\$699.99**
- IVA-18485-1063 10M and 6M Yagi, 5+6 Interlaced Elements, 22' Boom..... **\$949.99**
- IVA-18485-1064 10M and 6M Yagi, 6+7 Interlaced Elements, 29' Boom... **\$1,066.00**

Join our crew on Facebook for news and exclusive deals!

InnoVAntennas.com

6-Band HF-Plus Yagi

This heavy-duty 12-element HF-plus Yagi covers the 20, 17, 15, 12, 10, and 6 meter bands with a single coax connection to match modern HF+6M transceivers. Excellent performance is achieved by direct feed with no traps, coils or hairpins for class-leading radiating efficiency. This ruggedly built beam antenna delivers low SWR from 20M through 6M and is ready for harsh weather environments with aerospace grade T6 6066/6082 aluminum tubing, UV and temperature-protected insulators, and all stainless steel hardware. The stout, modest length 17.5' boom is made of 2" square tubing, and the antenna's interleaved and rigid fast-taper elements are designed to easily shed the wind.



IVA-18480-DXE126 20-6M 12-Element Yagi.....**\$1,860.00**



Rotatable Dipole HF Antennas

For two decades, Brazilian-based DIEX Antennas has been providing a proven solution for space-limited operators. The company's precision-crafted single-band full size, multiband shortened, single-band coil shortened, two-band coil shortened, and multiband trap shortened rigid rotatable dipole HF antennas are built with quality materials to withstand tough environments, provide good directionality depending on installed height above ground, and offer the flexibility to make adjustments to set the lowest SWR to a specific frequency. DIEX antennas are packed partially assembled, saving time and effort. Power handling below is further limited if using an antenna tuner.



Full Size Rigid Rotatable Dipoles

Built as a full size resonant dipole, these single-band aluminum tubing antennas provide excellent performance and are handled with a lighter tower and smaller rotator, offering an economical alternative to a Yagi. Power handling is 1,500W+ PEP.

DXA-DXFS6	Full Size 6M, 9.51'	\$74.99
DXA-DXFS10-11	Full Size 10M, 16.73'	\$87.99
DXA-DXFS12	Full Size 12M, 19.03'	\$91.99
DXA-DXFS15	Full Size 15M, 22.31'	\$97.99
DXA-DXFS17	Full Size 17M, 26.90'	\$116.99
DXA-DXFS20	Full Size 20M, 33.14'	\$136.99

Two-Band Coil Shortened Rigid Rotatable Dipoles

These dipoles provide coil-shortened specialized coverage of two non-adjacent HF bands. Power handling is 300W PEP SSB and 100W for digital.

DXA-DXA1040	Coil Shortened 40M, Full Size 10M, 26.25'	\$142.99
DXA-DXA1080	Coil Shortened 80M, Full Size 10M, 29.52'	\$159.99
DXA-DXA1230	Coil Shortened 30M, Full Size 12M, 33.14'	\$169.99
DXA-DXA1240	Coil Shortened 40M, Full Size 12M, 29.52'	\$146.99
DXA-DXA1280	Coil Shortened 80M, Full Size 12M, 30.84'	\$168.99
DXA-DXA1540	Coil Shortened 40M, Full Size 15M, 33.46'	\$159.99
DXA-DXA1580	Coil Shortened 80M, Full Size 15M, 38.71'	\$206.99
DXA-DXA1740	Coil Shortened 40M, Full Size 17M, 36.41'	\$168.99

Single-Band Coil Shortened Rigid Rotatable Dipoles

These dipoles provide coil-shortened specialized coverage for a single HF band. Power handling is 300W PEP SSB and 100W for digital for the 20, 30, and 60M models; 1,000W PEP for 80M; and 1,500W PEP for 40M.

DXA-DXM20	Coil Shortened 20M, 16.73'	\$142.99
DXA-DXM30	Coil Shortened 30M, 28.87'	\$159.99
DXA-DXM40	Coil Shortened 40M, 37.73'	\$281.99
DXA-DXM60	Coil Shortened 60M, 29.53'	\$223.99
DXA-DXM80	Coil Shortened 80M, 50.85'	\$449.99

Multiband Trap Shortened Rigid Rotatable Dipoles

These dipoles offer high-performance multiband operations and make an excellent choice when there's not enough space for a full size dipole or Yagi. Power handling is 1,500W PEP SSB.

DXA-DXS1	Trap Shortened 20/15/10M, 25.59'	\$272.99
DXA-DXS1-40	Trap Shortened 40/20/15/10M, 34.45'	\$506.99
DXA-DXS16	Trap Shortened 20/15/10/6M, 25.59'	\$347.99

Multiband Shortened Rigid Rotatable Dipoles

These multiband shortened dipoles deliver excellent performance (2.4 dBi gain) when space is at a premium. Power handling is 1,500W PEP.

DXA-DXW1	Shortened Dipole 17/12M, 21.65'	\$195.99
DXA-DXW1-30	Shortened Dipole 30/17/12M, 34.81'	\$304.99
DXA-DXW16	Shortened Dipole 17/12/6M, 21.65'	\$270.99
DXA-DXW16-30	Shortened Dipole 30/17/12/6M, 34.81'	\$379.99



InnoVAntennas

DX Engineering is proud to be the exclusive North American distributor of exceptionally crafted, high-performance InnoVAntennas antennas, produced in Herxheim, Germany by WiMo for InnoVAntennas Limited UK. Several models of these internationally popular antennas are now available at DX Engineering, including DXR Series Multiband HF Beams. Choose from nine models of DXR series Yagis, featuring short booms (10.2' to 12') with full-size elements or capacity-loaded shortened elements—all boasting excellent performance; low maintenance with no movable electrical parts; designs that deliver the best possible matching over a wide band range; 1.97" x 1.97" square booms with 0.078" wall thickness that require no bracing; use of UV-resistant insulators, stainless steel mounting hardware, and aviation-grade aluminum; and, in most cases, no need for an antenna tuner (SWR minimum can be precisely set by adjusting the element lengths). These antennas require no traps, matching links, or hairpins. Plus, only one feedline for all bands is connected directly to the solid distribution rails of the fed elements, making installation on a mast with a rotator easy. When limited space is a concern, "Super Compact" models, with the longest element shortened by a capacity hat (maximum length of 28.9'), offer a reduced turning radius.

IVA-DXR3	20/15/10M 6-Element Yagi, 10.2' Boom	\$1,439.99
IVA-DXR3C	Compact 20/15/10M 6-Element Yagi, 10.2' Boom	\$1,439.99
IVA-DXR4C	Compact 20/15/10/6M 8-Element Yagi, 10.2' Boom	\$1,439.99
IVA-DXR5	20/17/15/12/10M 9-Element Yagi, 10.8' Boom	\$1,775.99
IVA-DXR5C	Compact 20/17/15/12/10M 9-Element Yagi, 10.8' Boom	\$1,775.99
IVA-DXR6	20/17/15/12/10/6M 11-Element Yagi, 11.5' Boom	\$1,829.99
IVA-DXR6C	Compact 20/17/15/12/10/6M 11-Element Yagi, 11.5' Boom	\$1,829.99
IVA-DXR7	20/17/15/12/10/6/4M 14-Element Yagi, 12' Boom	\$1,899.99
IVA-DXR7C	Compact 20/17/15/12/10/6/4M 14-Element Yagi, 12' Boom	\$1,899.99

More from InnoVAntennas

Like its DXR Series, all of InnoVAntennas' HF, UHF, and VHF antennas are the result of applying the latest 64 bit commercial-grade Numerical Electromagnetic Calculation engines and advanced Particle Swarm Optimization to achieve cutting-edge, low-noise designs that let amateur radio operators hear weak signals better while ensuring long-lasting performance. Here are a few more models to choose from:

IVA-BOLPA-10	10-Element HF Band Optimized Log Periodic Antenna, 14-30 MHz, 25.3' Boom	\$2,190.00
IVA-DB6-6-4	Compact 6/4M 6-Element Dual-Band Yagi, 3.85' Boom	\$229.99
IVA-DELP-13	13-Element HF Log Periodic Dipole Array, 10-54 MHz, 37.7' Boom	\$4,100.00
IVA-DXC-140	40M Rotatable Dipole, 19.7' Boom	\$669.99
IVA-DXC-240	2-Element Compact 40M Yagi, 23' Boom	\$2,160.00

Enter "InnoVAntennas" at DXEngineering.com for more details.

InnoVAntennas.com

Log Periodic Array Antennas

These band-optimized log periodic array (BOLPA) models feature improved front-to-back ratio and gain compared to conventional 200 Ω LPDAs. These dipole arrays use a direct 50 Ω feedpoint. Models are available with 2, 3, or 4 elements. All antennas are built with top-grade materials, including aircraft aluminum booms and elements, UV-resistant insulators, and stainless steel hardware. Models undergo extensive testing and modeling to ensure stellar performance. Enter "IVA Log Periodic" at DXEngineering.com for more details.



IVA-18481-LPA2	2-Element Log Periodic, 26-30 MHz, 18' boom	\$489.99
IVA-18481-LPA3	3-Element Log Periodic, 24-30 MHz, 11.48' boom	\$665.99
IVA-18481-LPA4	4-Element Log Periodic, 21-30 MHz, 7.87' boom	\$1,194.99

Orders over \$99 qualify for FREE standard shipping—see pg. 74 for details.



Big Wheel 6M, 2M and 70cm Antennas

These omni-directional, horizontally polarized antennas make an ideal companion to deploy along with a directional beam antenna to make sure you don't miss that rare contact that may otherwise be lost. Great for weak signal work in SSB, CW or digital modes, they are constructed from stainless aluminum and stainless steel hardware. These unique antennas come in 6M (50-52 MHz, 1,000W, 141.7" diameter), 2M (144-146 MHz, 500W, 47.2" diameter), and 70cm (430-440 MHz, 200W, 13.4" diameter) versions. Users can expect gains of around 3dBd (vertical stacking of two Big Wheels will help you achieve omni-directional gain of approximately 5dBd using a monoband power divider or coaxial phasing harness that connects two same-band antennas to one coax feedline, sold separately). Antennas feature low-loss Type-N connectors. Enter "WiMo Big Wheel" at DXEngineering.com for more details.



- WMO-18009 Big Wheel 6M Antenna..... **\$259.99**
- WMO-18007 Big Wheel 2M Antenna..... **\$209.99**
- WMO-18008 Big Wheel 70cm Antenna... **\$159.99**



EAN-R2010201



EAN-R2010201



EAN-R2010202

Delta Loop Antennas

A delta loop antenna is an efficient way to get directional multi-band HF coverage, without installing a large HF Yagi or dipole. Made with aluminum tubing, these lightweight antennas are full-size vertical loops that deliver excellent low noise characteristics. When installed with a rotator, you can peak or null signals for the best reception. Both antennas handle 1,000 watts and require an antenna tuner. Check out the antenna tuners section of this catalog for compatible models. Wide range tuner required.



Part Number	Bands	Gain	Price
EAN-R2010201	30/20/17/15/12/10M	6.8 dBi	\$429.99
EAN-R2010202	20/17/15/12/10M	6.5 dBi	\$295.99

X-Quad Antennas for 144-146 and 430-440 MHz

A refined version of VHF and UHF cross-polarized Yagis, WiMo's lightweight and short-length X-Quad (well-known in Europe as a multi-element quad) comes loaded with special features made with amateur operators in mind: switchable polarization plane (horizontal/vertical/circular right/circular left/diagonal); high gain compared to other antenna forms due to its stacked elements, boom length, and compact design; end-boom or mid-boom centered mounting capabilities; and usefulness in operating satellites. The X-Quad can be optimally used for the desired polarization by simply changing the feed. All secondary elements (directors, reflectors) are active, which allows for its small profile. The X-Quad's elements are all electrically conductively connected with boom and cable outer sheath, eliminating interference from static charges. Antennas feature aluminum boom and elements, low-loss Type-N female connectors, and stainless steel hardware.



- WMO-18010 X-Quad Antenna, 2M, 12 Elements, 30" Transport Length, Type-N Female Connectors **\$279.99**
- WMO-18011 X-Quad Antenna, 70cm, 18 Elements, 25.6" Transport Length, Type-N Female Connectors **\$279.99**

Remote Polarization Switches

Developed exclusively for WiMo in the RF lab of SSB-Electronics, four models of mast-mountable and weatherproofed Remote Polarization Switches (for 2M and 70cm) allow users to easily select polarization plane (horizontal, vertical, right-hand circular and left-hand circular) on the X-Quad, or other third-party cross-polarized Yagis, for maximum convenience and performance. Remote operations require an additional 4-conductor DC control cable, sold separately.

- WMO-18080 Remote Polarization Switch, VHF, 300W **\$249.99**
- WMO-18081 Remote Polarization Switch, VHF, 800W **\$319.99**
- WMO-18082 Remote Polarization Switch, UHF, 200W **\$249.99**
- WMO-18083 Remote Polarization Switch, UHF, 600W **\$319.99**

2M and 70cm Circular Polarization Phase Lines

For use with X-Quad Antennas or other cross-polarized Yagis, these phase lines combine the vertical and horizontal elements into either right-hand or left-hand circular polarization, dependent upon beam-driven element position. Each cable set comes with two male Type-N connector cables, one for each polarization element, combined into one female Type-N connector for the main 50 ohm coaxial feedline to the station. (Not used with Remote Polarization Switches.)

- WMO-18049 Circular Polarization Phase Line for 70cm **\$81.99**
- WMO-18051 Circular Polarization Phase Line for 2M **\$81.99**



EAN-R2010252

VHF and UHF Directional Antennas

These antennas are built with only the highest quality stainless steel hardware and aircraft grade aluminum, using cutting-edge computer modeling and optimization techniques. EAntenna's precision construction results in state-of-the-art VHF and UHF antennas with excellent durability and wind survival capabilities.



EAN-R2010251



EAN-R2010106



EAN-R2010102



EAN-R2010400

Part Number	Band(s)	Max. Gain	Max. F/B	Boom Length	Price
EAN-R2010119	70cm	18 dBi	42.3 dB	14.1'	\$249.99
EAN-R2010107	70cm	19.2 dBi	37.5 dB	19.34'	\$349.99
EAN-R2010120	70cm	20.5 dBi	44.3 dB	27'	\$399.99
EAN-R2010250	2M/70cm	8.4 dBi	11 dB	2.30'	\$125.99
EAN-R2010251	2M/70cm	10.7 dBi	11.7 dB	3.94'	\$112.99
EAN-R2010252	2M/70cm	10.7 dBi	18.7 dB	4.95'	\$125.99
EAN-R2010105	2M	11.1 dBi	19 dB	5.97'	\$169.99
EAN-R2010149	2M	14.2 dBi	25.2 dB	14.75'	\$315.99
EAN-R2010117	2M	14.6 dBi	28.6 dB	16.39'	\$239.99
EAN-R2010103	2M	15.3 dBi	28.6 dB	20.16'	\$399.95
EAN-R2010118	2M	17.4 dBi	34 dB	35.8'	\$559.99
EAN-R2010400	6M	6 dBi	25 dB	2.95'	\$169.99
EAN-R2010106	6M	9.4 dBi	23 dB	9.85'	\$259.99
EAN-R2010109	6M	8.6 dBi	14.4 dB	4.6'	\$209.99
EAN-R2010102	6M	10.6 dBi	24.8 dB	14.68'	\$366.00
EAN-R2010115	6M	11.8 dBi	22.3 dB	19.4'	\$489.99
EAN-R2010113	6M	12.0 dBi	25.4 dB	20.1'	\$499.99
EAN-R2010114	6M	12.0 dBi	25.4 dB	20.75'	\$499.99
EAN-R2010108	6M	11.8 dBi	28 dB	22.78'	\$509.99
EAN-R2010111	6M	12.9 dBi	32 dB	30.8'	\$679.99
EAN-R2010150	6M	14.1 dBi	29.0 dB	41.2'	\$799.99
EAN-R2010123	6M	14.7 dBi	27.1 dB	49.6'	\$799.99
EAN-R2010104	6M	15.3 dBi	40.0 dB	58.3'	\$899.99

Need help with your project? Call the tech line at 330-572-3200!



VHF/UHF Antennas

M2 Antennas uses computer modeling technology, weather resistant materials and CNC-machined elements to create the best performing antennas possible. Here is the complete line of its VHF/UHF offering. Find full details at DXEngineering.com.

Part Number	Band	Gain	Elements	Boom	Price
Yagi Antennas					
MSQ-6M3	6M	8.2 dBi	3	6.8'	\$385.99
MSQ-6M3SS	6M	8.1 dBi	3	5.5'	\$374.99
MSQ-2M3SS	2M	8.3 dBi	3	3.1'	\$239.99
MSQ-2M4X	2M	9.6 dBi	4	4'	\$229.99
MSQ-2M7X	2M	12.3 dBi	7	8.9'	\$258.99
MSQ-2M9X	2M	14.1 dBi	9	14'	\$403.99
MSQ-2M12	2M	14.6 dBi	12	19.5'	\$578.99
MSQ-2225SS	1.25M	10.3 dBi	5	3'	\$229.99
MSQ-22210EZ	1.25M	14.4 dBi	10	9.75'	\$373.99
MSQ-4406SS	70cm	11 dBi	6	3'	\$188.99
MSQ-440-11X	70cm	13.4 dBi	11	5'	\$258.99
MSQ-440-18X	70cm	16.6 dBi	18	11'	\$300.99
MSQ-432-6WL	70cm	18 dBi	21	14.5'	\$455.99
MSQ-4329WL	70cm	19.4 dBi	28	21'	\$599.99
Circular Polarity Beam Antennas					
MSQ-2MCP14	2M	12.3 dBic	14	10.5'	\$662.99
MSQ-436CP30	70cm	15.5 dBic	30	9.75'	\$643.99



Rotatable Dipole Antennas

The World Ranger dipoles provide bi-directional patterns with rotatable convenience. You can mount them high and away from the trees for better performance than a wire dipole. These single and multi-band dipoles feature high-performance traps, heavy wall tubing and rugged hardware for years of enjoyment.



Part Number	Band(s)	Gain	Turning Radius	Price
CSH-D4	40/20/15/10M	2.1 dBi	17.9'	\$599.95
CSH-D40	40M	2.1 dBi	21.1'	\$499.95



VHF/UHF Log Periodic Antennas

If you don't have the space (or friendly neighbors) to put up several VHF and UHF antennas, Create offers you an uncompromising single antenna option. Using 21 elements, the wideband directional CLP-5130-1N gets you on the 1.25, 2 and 6 meter bands, plus the 23, 33 and 70cm bands. It handles 500 watts and gives you an average gain of 10 dBi. With a 6.66 foot boom length, it's compact enough to go almost anywhere and at 11 pounds, it's perfect for most rotators. You can also use this antenna for VHF/UHF TV, FM broadcast, aviation and government communication applications. Create's CLP-5130-2N is similar to the 1N, except it provides 11 dBi of gain and doesn't offer coverage on the 6 meter band.

CAE-CLP-5130-1N	VHF/UHF Log Periodic Antenna, 6-Band	\$519.99
CAE-CLP-5130-2N	VHF/UHF Log Periodic Antenna, 5-Band	\$379.99

HO LOOP Antennas

These antennas give you excellent SSB and CW communications with a reach of over 200 miles. Excellent for mobile or base weak-signal stations, these antennas offer omnidirectional coverage without a rotator. HO LOOP Antennas' horizontal polarity means you get upwards of 5 dB ground gain over a traditional vertical antenna. Plus, the higher you mount your HO LOOP, the more gain you achieve.

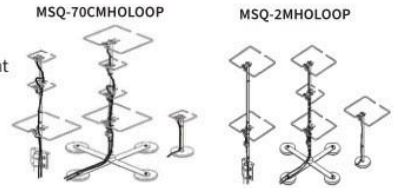

The Mast Bracket kit allows you to install your HO LOOP antenna on any 1.25 to 2 inch diameter mast. It includes all the brackets, cradles and hardware you'll need. For 6M HO LOOP antennas, be sure to order the additional support bracket. Stacked gain with optional items.

MSQ-2MHOOLOOP	2M HO LOOP, 4 dBd Gain (10')/8 dBd Gain (6.83' & 11')	\$143.99
MSQ-6MHOOLOOP	6M HO LOOP, 4.2 dBd Gain (11')/8.2 dBd Gain (40' and 52')	\$229.99
MSQ-70CMHOLOOP	432 MHz/70cm HO LOOP, 5 dBd Gain (7.17')/8.8 dBd Gain (7' and 8.3')	\$115.99
MSQ-MASTBRKTKIT	HO LOOP Base Installation Hardware	\$54.99

M2 Antennas Power Dividers

Add 3 dB gain with two antennas and nearly 6 dB gain with four antennas using M2 Antennas Power Dividers on properly spaced VHF and UHF stacked arrays. These non-isolation RF combiners match impedances for two or four Loop or Yagi antennas fed in phase with equal lengths of 50 Ω coax.

They feature Type N connectors and are rated at 3 kW. The 6 meter models are made with low loss coax and all other band models are aluminum tubing, blocks and solid metal center conductors with air dielectric for nearly immeasurable loss of less than 0.1 dB. Each pair of stacked antennas nearly doubles the effective radiated power of your station!

MSQ-70CM2PRTPD	Power Divider for 70cm	\$248.99
MSQ-2M2PRTPD	Power Divider for 2M	\$248.99

Find the right Power Divider for your application at DXEngineering.com.



Eggbeater Satellite Antennas

Shoot for the stars with antennas that let you contact other Hams using Amateur Satellites and communicate directly with the International Space Station! These antennas are equally effective in your base or mobile station. They produce smooth, omnidirectional horizontal polarity patterns at the horizon. Above the horizon, the pattern transforms to right-hand circular for excellent OSCAR communications. The small physical footprint of these antennas allows many mounting options at a budget-friendly price.

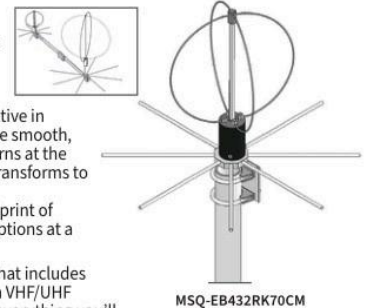

A Satellite Antenna Package is available that includes the 2M and 70cm antennas, a cross boom VHF/UHF kit and mounting hardware—practically everything you'll need to open up a new world of Amateur communications. Visit DXEngineering.com for complete details.

MSQ-EB144RK2M	Satellite Eggbeater Antenna, 2 Meter Band	\$387.99
MSQ-EB432RK70CM	Satellite Eggbeater Antenna, 70cm Band	\$358.99
MSQ-SATPACK1	Satellite Antenna Package, 2M and 70cm, Cross Boom	\$719.99

Satellite Antenna Cross Boom

M2 Antennas' Cross Boom helps you mount multiple Yagi (or Eggbeater) antennas. Thanks to its heavy-duty construction, the cross boom won't distort your antenna patterns. Use the boom for critical VHF/UHF/SHF satellite uplink-downlink systems, EME (moon bounce) and long-range terrestrial operations. It features a super-strong 1.625" solid aluminum rod center section with two 2" O.D., 60" long, 1/4" thick-wall fiberglass tubing sections to secure large systems or arrays. Built for years of slip-free service, the cross boom eliminates the worry of crushing, cracking or splintering the center portion of an all-fiberglass cross boom. **Enter "M2 Solid Cross" at DXEngineering.com for more applications.**



MSQ-CB60	Satellite Antenna Cross Boom, Heavy-Duty, 11'	\$389.99
----------	---	-----------------

Orders by 10 pm ET ship the same day. See pg. 74 for details.

Moxon Yagi for 10 and 6 Meters



This EAntenna's horizontally polarized, directional antenna (model 2850MO) is a great choice for making Sporadic-E QSOs on 10 and 6 meters, as well as for local and regional weak-signal operations on SSB, CW, and digital modes. With the ability to fit well on an existing mast where space is limited, this relatively compact dual-band antenna can be an ideal solution for property-restricted areas and for temporary or portable operations. The five-element Moxon Yagi features a short boom (5.9'); gains of 8.3 dBi on 10M, 10.5 dBi on 6M; a flat SWR curve over a wide bandwidth; 3,000W power rating; and front-to-back-ratio of 12 dB on 10M, 21 dB on 6M. It requires only one coax feedline and includes a 3kW balun with SO-239 connector.



WMO-17824-2850 Moxon Yagi for 10/6 Meters.....\$375.99

6 Meter Rectangular Quad Loop Antennas



Rule the "Magic Band" with a rugged loop antenna. These antennas capitalize on the time-tested quad loop design to give you impressive performance with a relatively small, easy-to-rotate antenna.



Part Number	Max. Gain	Max. F/B	Boom Length	Price
EAN-R2010451	9.5 dBi	13.6 dB	7.7'	\$299.99
EAN-R2010450	6.7 dBi	22.85 dB	9.53'	\$165.99



Mobile/Base Discone Antennas

Take advantage of the wideband properties of Diamond's Discone Antennas. They're perfect for Amateur Radio, commercial two-way, cellular, air traffic and utility frequencies. You can also use these as "shop" antennas to test your transmitters with one run of coaxial cable. These versatile, yet compact antennas are rust-resistant and durable.



Part Number	Description	Height	TX Frequency	RX Frequency	Price
DMN-D130J	Super Discone, SO-239, Base	66.9"	50-1300 MHz	25-1300 MHz	\$124.99
DMN-D130NJ	Super Discone, Type N, Base	66.9"	50-1300 MHz	25-1300 MHz	\$124.99
DMN-D3000N	Super Discone, Type N, Base	66.9"	50-1200 MHz	25-3000 MHz	\$156.99

*Designed for Diamond's K400S, K400C, K600M and K600S Mobile Mounts



Discone Antenna

Get super-wide frequency coverage in a compact package. This antenna has excellent reception from 100 MHz to 2.3 GHz; plus excellent transmit capabilities on many popular bands including 2M, 70cm and 23cm. It is only 3 feet high, mounts to any 2 inch mast and includes 49 feet of coax with an N connector.

ICO-AH-8000 Discone Antenna...\$289.99



VHF/UHF Yagi Antennas

Cushcraft engineers used computer-aided modeling and test range techniques to optimize the performance of these popular VHF and UHF Yagis. That means you get more gain and cleaner patterns with excellent front-to-back ratios. The gain figures listed below are based off the highest peak rating; find comprehensive specs at DXEngineering.com.

S-series antennas, denoted by an "S" at the end of the part number, have very broad bandwidth so they will not detune in bad weather. The S-series also features stainless steel hardware.

Cushcraft also makes Power Dividers to make it easy to stack these antennas, available in 2- or 4-antenna configurations. They serve as a T-harness; simply connect your incoming 50 Ω coax to the center and it splits your outgoing line in two.

Part Number	Band(s)	Gain	Elements	Boom	Price
CSH-A503S	6M	8.0 dBi	3	6'	\$259.95
CSH-A505S	6M	10.5 dBi	5	12'	\$399.95
CSH-A506S	6M	11.6 dBi	6	20'	\$529.95
CSH-A627013S	6M/2M/70cm	10.0 dBi	13	14'	\$399.95
CSH-A2706S	2M/70cm	7.8 dBi	6	2.8'	\$199.95
CSH-A27010S	2M/70cm	10.0 dBi	10	6.1'	\$239.95
CSH-A1483S	2M	7.8 dBi	3	2.8'	\$119.95
CSH-A14810S	2M	13.3 dBi	10	12'	\$209.95
CSH-A14820T	2M	11.1 dBd	20	11'	\$279.95
CSH-A124WB	2M	10.2 dBi	4	4'	\$179.95
CSH-A13B2	2M	15.8 dBi	13	15'	\$339.95
CSH-A26B2	2M	18.8 dBi	26	15'	\$749.95
CSH-A17B2	2M	18.0 dBi	17	31'	\$549.95
CSH-A224WB	1.25M	10.2 dBi	4	3'	\$159.95
CSH-A719B	70cm	15.5 dBd	19	13.5'	\$339.95
CSH-A43011S	70cm	13.2 dBi	11	4.7'	\$179.95
CSH-A4496S	70cm	10.5 dBi	6	2.9'	\$129.95
CSH-A44911S	70cm	13.2 dBi	11	4.2'	\$179.95



Discone Base Station Scanner Antenna

Match this antenna to your scanner and get excellent reception on public service, aircraft, mobile and telephone frequencies. It's vertically polarized, covers 40 to 950 MHz and doesn't need adjusting. The antenna is 54 inches high with an 18 inch diameter. A 50 foot cable with a BNC male connector is included.

HSR-DCL-B Discone Base Station Antenna...\$64.99

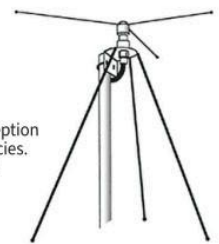

DS-150S Discone Base Antenna

If you're living in an apartment where space is limited or in a community where larger antennas are frowned upon, then this compact antenna will let you stay in the game. It is less than five feet high and three feet wide, but covers 25 to 1300 MHz (receive). Transmitting is possible on the 6M, 2M, 70cm and 33cm bands, plus 1.2 GHz without a tuner. This antenna could be the perfect solution for your scanner or VHF/UHF transceiver.

CMA-DS-150S Discone Base Antenna \$129.99

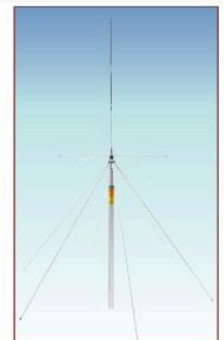

Need advice? 1-330-572-3200 or DXEngineering@DXEngineering.com



More Diamond Base/Repeater Antennas
Find Complete Specs at DXEngineering.com
Multi-Band Resonant Vertical Antennas

(1.4" to 2.4" OD Mast Required)

Part Number	Bands	Height	Power Rating	Price
DMN-CP5H	40/10/15/6M	11.7'	500 Watts	\$434.99
DMN-CP6AR	80/40/15/10/6M	15.1'	200 Watts	\$469.99
DMN-CP610	10/6M	22.0'	500 Watts	\$279.99

Monoband Base/Repeater Antennas (1.25" to 2.4" OD Mast Required)

Part Number	Band	Height	Power Rating	Gain	Price
DMN-CP62	6 Meter	22.0'	200 Watts	5.5 dBi	\$234.99
DMN-CP22E	2 Meter	8.9'	200 Watts	6.5 dBi	\$64.99
DMN-F22A	2 Meter	10.5'	200 Watts	6.71 dBi	\$102.99
DMN-F23H	2 Meter	15'	350 Watts	7.8 dBi	\$169.99
DMN-F142A	1.25 Meter	6'	150 Watts	5.5 dBi	\$132.95
DMN-F718A	70cm	15'	250 Watts	11.5 dBi	\$219.99
DMN-F1230AII	23cm	11.5'	100 Watts	13.8 dBi	\$174.99

Dual-Band Base/Repeater Antennas (1.25" to 2.4" OD Mast Required)

Part Number	Bands (Connector)	Height	Power Rating	Gain	Price
DMN-X2200A	2M/1.25M (SO-239)	10'	150 Watts	6 dBi (2M) 7.8 dBi (1.25M)	\$198.95
DMN-X30A	2M/70cm (SO-239)	4.5'	150 Watts	3 dBi (2M) 5.5 dBi (70cm)	\$72.99
DMN-X50A	2M/70cm (SO-239)	5.6'	200 W (2M) 250 W (70cm)	4.5 dBi (2M) 7.2 dBi (70cm)	\$99.95
DMN-X50NA	2M/70cm (Type N)	5.6'	200 W (2M) 250 W (70cm)	4.5 dBi (2M) 7.2 dBi (70cm)	\$99.95
DMN-X200A	2M/70cm (SO-239)	8.3'	200 Watts	6 dBi (2M) 8 dBi (70cm)	\$129.99
DMN-X300A	2M/70cm (SO-239)	10'	200 Watts	6.5 dBi (2M) 9 dBi (70cm)	\$149.99
DMN-X300NA	2M/70cm (Type N)	10'	200 Watts	6.5 dBi (2M) 9 dBi (70cm)	\$149.99
DMN-X510HDM	2M/70cm (SO-239)	17.2'	330 W (2M) 250 W (70cm)	8.3 dBi (2M) 11.7 dBi (70cm)	\$209.99
DMN-X510HDNA	2M/70cm (Type N)	17.2'	330 W (2M) 250 W (70cm)	8.3 dBi (2M) 11.7 dBi (70cm)	\$209.99
DMN-X510NJ	2M/70cm (Type N)	17.2'	200 Watts	8.3 dBi (2M) 11.7 dBi (70cm)	\$219.99
DMN-X700HNA	2M/70cm (Type N)	24'	200 Watts	9.3 dBi (2M) 13 dBi (70cm)	\$434.99

Tri-Band Base/Repeater Antennas (1.25" to 2.4" OD Mast Required)

Part Number	Bands	Height	Power Rating	Gain	Price
DMN-V2000A	6M/2M/70cm	8.3'	150 Watts	2.1 dBi (6M) 6.2 dBi (2M) 8.4 dBi (70cm)	\$169.99
DMN-X6000A	2M/70cm/23cm	10.5'	100 W (2M) 100 W (1.25M) 60 W (23cm)	6.5 dBi (2M) 9 dBi (70cm) 10 dBi (23cm)	\$199.99

Yagi Beam Base Antennas

Part Number	Band	Elements	Boom Length	Power Rating	Gain	Price
DMN-A502HB	6 Meter	2	2.5'	400 Watts	6.3 dBi	\$135.99
DMN-A144S5	2 Meter	5	3.1'	100 Watts	9.1 dBi	\$69.99
DMN-A144S10	2 Meter	10	6.99'	50 Watts	11.6 dBi	\$114.99
DMN-A430S10	70cm	10	3.9'	100 Watts	13.1 dBi	\$75.99
DMN-A430S15	70cm	15	7.4'	100 Watts	14.8 dBi	\$94.99

Wi-Fi Antennas



For exceptional performance at 2.4 GHz, Comet offers three options. Full details on coverage and dimensions are at DXEngineering.com.

Comet's GP-24R High Gain Wi-Fi Access Point Antenna delivers a whopping a 12 dBi gain in a narrow elevation pattern. It provides excellent coverage because it reaches out directly towards the horizon.

Designed to meet strict coverage requirements, the GP-24-3R and GP-24SR antennas are well suited for Wi-Fi, MESH, base or repeater installations. They have a heavy-duty fiberglass radome, with stainless steel clamps.

CMA-GP-24R	High Gain Wi-Fi Access Point Antenna	\$179.99
CMA-GP-24-3R	Omnidirectional 2.4 GHz Base Antenna, 70" Tall	\$179.99
CMA-GP-24SR	Omnidirectional 2.4 GHz Base Antenna, 39" Tall	\$129.99

CMA-GP-24R



6 Meter VHF Monoband Vertical Antenna

It's an excellent 6M, 5/8-wave vertical antenna that delivers up to 6.4 dBi gain, which makes it perfect for SSB operation. It's got a full-size radiator with a lower takeoff angle, which means the power is directed closer to the horizon where you want it. Use the tuned radials at the antenna's base to achieve a bandwidth over 4 MHz and a SWR of 2:1 or less. This antenna also has a shunt-fed matching system, which drains static to dramatically reduce unwanted noise. The antenna stands about 8 feet tall and will handle 300 watts.

HSR-G-3754 6M VHF Monoband Vertical Antenna..... **\$299.99**

G-Series Vertical Antennas

Hustler's acclaimed G-Series antennas deliver impressive performance in easy-to-assemble packages. These antennas represent the perfect union of price, coverage and results. They're made from high-quality materials, so they stand up to Mother Nature and give you years of reliable use.

Part Number	Band(s)	Gain	Power Handling	Height	Price
HSR-G7-144	2M	7.0 dBi	600 W	15.33'	\$389.99
HSR-G6-144B	2M	6.0 dBi	600 W	9.75'	\$251.99
HSR-G3-144	2M	3.0 dBi	200 W	7.42'	\$117.99
HSR-G7-220	1.25M	7.0 dBi	1,000 W	9.75'	\$389.99
HSR-G6-440	70cm	6.0 dBi	100 W	7.25'	\$351.99
HSR-G6-270R	2M/70cm	6.0 dBi	100 W	7.50'	\$339.99



Vertical VHF/UHF Antennas



Reach out further and get maximum performance with Comet Antennas. These antennas all feature durable construction, so they are ideal for rough-weather environments. There are fiberglass and aluminum options for many applications and every antenna comes with Comet's superior quality, coverage and gain. The complete specs on every Comet Antenna can be found at DXEngineering.com.

Part Number	Coverage	Gain	Connector	Height	Price
CMA-GP-21	23cm	14.9 dBi	Type N (F)	8'	\$174.99
CMA-KP-20	33cm	9.2 dBi	Type N (F)	8'	\$149.99
CMA-CA-712EF	70cm	9 dBi	SO-239	10.5'	\$139.99
CMA-CA-F72GF	70cm	5.5 dBi	Type N (F)	3.5'	\$129.99
CMA-CA-SUPER22	1.25M	6.6 dBi	SO-239	8'	\$159.99
CMA-CA-F22GF	2M	5.5 dBi	SO-239	8.9'	\$174.99
CMA-CA-F22GFN	2M	5.5 dBi	Type N (F)	8.9'	\$174.99
CMA-CFM-95SSL	88-108 MHz	3.4 dBi	SO-239	7.7'	\$115.99
CMA-GP-1	2M/70cm	3/6 dBi	SO-239	4'	\$79.99
CMA-GP-3	2M/70cm	4.5/7.2 dBi	SO-239	5.9'	\$104.99
CMA-GP-6	2M/70cm	6.5/9 dBi	SO-239	10.1'	\$169.99
CMA-GP-9	2M/70cm	8.5/11.9 dBi	SO-239	18.5'	\$219.99
CMA-GP-9N	2M/70cm	8.5/11.9 dBi	Type N (F)	18.5'	\$219.99
CMA-CX-333	2M/1.25M/70cm	6.5/7.8/9 dBi	SO-239	10.4'	\$184.99
CMA-GP-95	2M/70cm/23cm	6/8.6/12.8 dBi	Type N (F)	8'	\$179.99
CMA-GP-98	2M/70cm/23cm	6.5/9/13.5 dBi	Type N (F)	9.7'	\$209.99
CMA-GP-15	6M/2M/70cm	3/6.2/8.6 dBi	SO-239	7.9'	\$174.99

CMA-GP-3



VHF/UHF Beam Antennas

Comet offers you two stellar Yagi antennas, one for the 6M band and one for the 23cm band. They're compact and lightweight, and have stainless steel hardware so they're rugged enough to last for years. Installation is easy, and the CYA-1216E comes pre-assembled.

CMA-CYA-1216E	23cm Beam Antenna, 5.25' Boom, 16-Element, 16.6 dBi Gain	\$179.99
CMA-CA-52HB4	6M Wideband Beam Antenna, 10.5' Boom, 4-Element, 10.5 dBi Gain	\$189.99

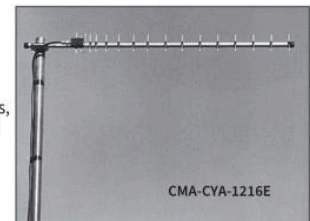

We're All Elmers Here! Get Expert Support at: Elmer@DXEngineering.com



Comet Duplexers	Port*	Frequency	PEP	Loss	Isolation	Mix Connector	Port Connector	Price
CMA-CF-360B	LPF HPF	1.3-30 MHz 49-470 MHz	600 W 600 W	.2 dB .2 dB	45 dB	PL-259	SO-239 SO-239	\$69.99
CMA-CF-413B	LPF HPF	1.3-500 MHz 840-1300 MHz	500 W 200 W	.25 dB .4 dB	60 dB	Type N Female	PL-259 Type N Male	\$65.99
CMA-CF-416A	LPF HPF	1.3-170 MHz 350-540 MHz	800 W 500 W	.15 dB .25 dB	60 dB	SO-239	PL-259 PL-259	\$54.99
CMA-CF-416B	LPF HPF	1.3-170 MHz 350-540 MHz	800 W 500 W	.15 dB .25 dB	60 dB	SO-239	PL-259 Type N Male	\$54.99
CMA-CF-416W	LPF HPF	1.2-250 MHz 400-1400 MHz	400 W 200 W	.2 dB .3 dB	30 dB	Type N Female	PL-259 Type N Male	\$69.99
CMA-CF-4160I	LPF HPF	1.3-170 MHz 350-540 MHz	800 W 500 W	.1 dB .2 dB	60 dB	SO-239	PL-259 Type N Male	\$54.99
CMA-CF-4160J	LPF HPF	1.3-170 MHz 350-540 MHz	800 W 500 W	.1 dB .2 dB	60 dB	SO-239	SO-239 SO-239	\$54.99
CMA-CF-4160N	LPF HPF	1.3-170 MHz 350-540 MHz	800 W 500 W	.1 dB .2 dB	60 dB	Type N Female	Type N Female Type N Female	\$58.99
CMA-CF-530	LPF HPF	1.3-90 MHz 125-470 MHz	600 W 600 W	.2 dB .2 dB	45 dB	SO-239	PL-259 PL-259	\$78.99
CMA-CF-530C	LPF HPF	1.3-90 MHz 125-470 MHz	600 W 600 W	.2 dB .2 dB	45 dB	PL-259	SO-239 SO-239	\$76.99
Comet Triplexers	Port*	Frequency	PEP	Loss	Isolation	Mix Connector	Port Connector	Price
CMA-CFX-324A	LPF BPF HPF	1.3-150 MHz 200-320 MHz 390-500 MHz	600 W 600 W 600 W	.2 dB .25 dB .3 dB	40 dB	SO-239	PL-259 PL-259 PL-259	\$88.99
CMA-CFX-324J	LPF BPF HPF	1.3-150 MHz 200-320 MHz 390-500 MHz	600 W 600 W 600 W	.2 dB .25 dB .3 dB	40 dB	SO-239	SO-239 SO-239 SO-239	\$87.95
CMA-CFX-431A	LPF BPF HPF	1.3-150 MHz 350-500 MHz 840-1400 MHz	600 W 600 W 600 W	0.2 dB 0.2 dB 0.2 dB	45 dB	Type N Female	PL-259 PL-259 Type N Male	\$89.99
CMA-CFX-514J	LPF BPF HPF	1.3-90 MHz 130-200 MHz 380-500 MHz	800 W 800 W 500 W	.15 dB .2 dB .25 dB	55 dB	SO-239	SO-239 SO-239 SO-239	\$79.99
CMA-CFX-514N	LPF BPF HPF	1.3-90 MHz 130-200 MHz 380-500 MHz	800 W 800 W 500 W	.2 dB .25 dB .3 dB	55 dB	SO-239	PL-259 PL-259 Type N Male	\$82.99



CMA-CF-416A



CMA-CF-4160J



CMA-CF-4160N



CMA-CFX-324A



CMA-CFX-431A

Diamond Duplexers	Port*	Frequency	FM	PEP	Loss	Isolation	Mix Connector	Port Connector	Price
DMN-MX62M	LPF HPF	1.6-56 MHz 76-470 MHz	200 W 200 W	600 W 600 W	.2 dB .3 dB	50 dB 50 dB	SO-239	PL-259, 12" 5D Cable PL-259, 12" 5D Cable	\$78.99
DMN-MX610	LPF HPF	1.3-30 MHz 49-470 MHz	200 W 200 W	600 W 600 W	.2 dB .25 dB	45 dB 45 dB	SO-239	PL-259, No Cable	\$69.99
DMN-MX72D	LPF HPF	1.6-30 MHz 140-150 MHz 400-600 MHz	400 W 150 W 100 W	1,000 W 400 W 250 W	.1 dB .1 dB .2 dB	60 dB 60 dB 60 dB	SO-239	PL-259, No Cable PL-259, No Cable	\$46.99
DMN-MX72H	LPF HPF	1.6-30 MHz 140-150 MHz 400-600 MHz	400 W 150 W 100 W	1,000 W 400 W 250 W	.1 dB .1 dB .2 dB	60 dB 60 dB 60 dB	SO-239	PL-259, 12" 5D Cable PL-259, 12" 5D Cable	\$49.99
DMN-MX72N	LPF HPF	1.6-30 MHz 140-150 MHz 400-460 MHz	400 W 150 W 100 W	1,000 W 400 W 250 W	.1 dB .1 dB .1 dB	60 dB 60 dB 60 dB	SO-239	PL-259, 12" 5D Cable Type N Male, 12" 5D Cable	\$49.99
DMN-MX72A	LPF HPF	1.6-30 MHz 140-150 MHz 400-460 MHz	400 W 150 W 100 W	1,000 W 400 W 250 W	.1 dB .1 dB .1 dB	60 dB 60 dB 60 dB	Type N Female	PL-259, 12" 5D Cable PL-259, 12" 5D Cable	\$54.99
DMN-MX214	LPF HPF	140-150 MHz 400-460 MHz	150W 100W	300 W 200 W	.3 dB .4 dB	45 dB 45 dB	SO-239	PL-259, 12" 5D Cable PL-259, 12" 5D Cable	\$65.95
Diamond Triplexers	Port*	Frequency	FM	PEP	Loss	Isolation	Mix Connector	Port Connector	Price
DMN-MX324	LPF BPF HPF	1.6-150 MHz 220-225 MHz 400-550 MHz	400 W 300 W 250 W	800 W 600 W 500 W	.3 dB .4 dB .4 dB	40 dB 40 dB 40 dB	SO-239	PL-259, 12" 5D Cable PL-259, 12" 5D Cable PL-259, 12" 5D Cable	\$89.99
DMN-MX2000	LPF BPF HPF	1.6-60 MHz 110-170 MHz 300-950 MHz	400 W 400 W 250 W	800 W 800 W 500 W	.15 dB .2 dB .25 dB	60 dB 60 dB 60 dB	SO-239	PL-259, 12" 5D Cable PL-259, 12" 5D Cable PL-259, 12" 5D Cable	\$89.99
DMN-MX2000N	LPF BPF HPF	1.6-60 MHz 110-170 MHz 300-950 MHz	400 W 400 W 250 W	800 W 800 W 500 W	.15 dB .2 dB .25 dB	60 dB 60 dB 60 dB	SO-239	PL-259, 12" 5D Cable PL-259, 12" 5D Cable Type N Male, 12" 5D Cable	\$93.99
DMN-MX3000	LPF BPF HPF	1.6-160 MHz 350-500 MHz 850-1300 MHz	400 W 200 W 100 W	800 W 400 W 200 W	.2 dB .3 dB .4 dB	55 dB 55 dB 55 dB	Type N Female	PL-259, 12" 5D Cable PL-259, 12" 5D Cable Type N Male, 12" 5D Cable	\$89.99
DMN-MX3000N	LPF BPF HPF	1.6-160 MHz 350-500 MHz 850-1300 MHz	400 W 200 W 100 W	800 W 400 W 200 W	.2 dB .3 dB .4 dB	55 dB 55 dB 55 dB	Type N Female	PL-259, 12" 5D Cable Type N Male, 12" 5D Cable Type N Male, 12" 5D Cable	\$89.99



DMN-MX72N



DMN-MX2000



DMN-MX3000

*LPF: Low Pass Filter, BPF: Band Pass Filter, HPF: High Pass Filter

How to Order from DX Engineering:

- Online at www.DXEngineering.com
- By Phone: 1-800-777-0703
- By Fax: 1-330-572-3279
- International Phone Orders: 1-330-572-3200

Please provide your e-mail address for most efficient correspondence and to receive order confirmation notices.

Hours of Operation**Ordering (via phone)**

Eastern Time: Monday-Friday: 8:30 am to Midnight ET
Eastern Time: Saturday & Sunday: 9 am to 5 pm

Ordering (online)

Order at www.DXEngineering.com 24 hours a day, 7 days a week

Phone or e-mail Technical Support

Eastern Time: Monday-Friday: 9 am to 7 pm ET
Saturday: 9 am to 5 pm DXEngineering@DXEngineering.com

Ohio Showroom Staffing Hours

Eastern Time: Monday-Saturday: 9 am to 5 pm ET

Ohio Curbside Pickup:

9 am to 8 pm ET, Monday-Saturday
9 am to 7 pm ET, Sunday

Nevada Curbside Pickup:

9 am to 7 pm PT, Monday-Sunday

Freight, Shipping and Handling Policies

We ship most orders via fast ground service at no additional charge (to the contiguous 48 states). Most orders for in-stock parts are shipped the same day. Most orders arrive in 1-2 days via ground service in the contiguous 48 states.

Note: We will verify all credit orders for your protection. In some cases, this process may cause a slight delay in shipping.

Shipping and Handling

Domestic and APO/FPO (United States, excluding HI, AK, PR, U.S. Territories)

Orders over \$99 qualify for free standard shipping. Shipping and handling on domestic and APO/FPO orders is based on order subtotal and non-refundable. Please note, shipping and handling fees are subject to change. For current rates, visit the Help Center at DXEngineering.com.

Oversize items: An oversize fee applies to select items (due to size and/or weight) as indicated at DXEngineering.com.

Truck freight fees are charged for products that are too large or too heavy for regular ground service, as indicated at DXEngineering.com. These rates do not include lift gate fees. The shipping carrier will contact you to schedule a distribution center pick-up or home delivery time. Find more information in the online Help Center at DXEngineering.com or call.

In-stock parts: Most orders on in-stock parts are shipped the same day and arrive in 1-2 days via ground service in the contiguous 48 states. Exact order-by time is subject to shipper availability. Visit the Help Center at DXEngineering.com for more information about order status and tracking, plus Next Day Air and Saturday Delivery options.

Domestic Non-Standard Shipping Options:

Rates for Next Day Air, 2-Day Air, 2-Day Air Saturday, and Next Day Air Saturday (where available) are listed in the online Help Center at DXEngineering.com.

Sales Tax

DX Engineering collects and remits sales tax based on state and local requirements. Prices are subject to change without notice. Occasionally, prices increase or decrease after a catalog is printed. For the most up to date pricing and in-stock status, visit DXEngineering.com.

Prices are subject to change without notice.

If you have any further questions, please send us an e-mail at DXEngineering@DXEngineering.com or contact us at 1-800-777-0703.

Ordering Details

We cannot ship to a P.O. Box in the contiguous 48 United States. APO/FPO orders can only ship via U.S. Postal Service and must be pre-paid by a check or credit card. Truck Freight, Hazardous Materials, and some oversize items cannot be shipped to APO/FPO addresses.

HI, AK, PR, and U.S. Territory

Shipping and handling is based on the method selected. See the options and fees at DXEngineering.com or call us. Shipping and handling is non-refundable.

International and Canadian (outside of the U.S. or U.S. Territories):

Order at DXEngineering.com or call 1-330-572-3200. Shipping and handling is based on carrier selection and destination. If an item is backordered, your item will be held until ALL items are in stock. Obtain quotes at International@support.DXEngineering.com. Shipping and handling is non-refundable. If you choose a Landed Cost Delivery provider, all duties, taxes, and clearance fees are included at checkout. Otherwise duties and taxes will be billed to you by the shipping company at the time of delivery. Visit the online Help Center at DXEngineering.com or ask your sales rep for more details.

About Backorders

For customers in the continental U.S. and all U.S. territories: in-stock parts usually ship immediately. Most backordered parts ship as they become available, which may result in multiple shipments for a single order. You will be charged for in-stock parts and parts that dropship directly from our supplier when they are ordered. Visit the online Help Center at DXEngineering.com or ask your sales rep for payment information and more details. International information listed above.

Product Warranties**DX Engineering Products**

All products manufactured by DX Engineering are warranted to be free from defects in materials and workmanship for a period of one (1) year from date of shipment. DX Engineering's sole obligation under this warranty shall be to issue credit, repair, or replace any item or part thereof which is proved to be other than as warranted. No allowance shall be made for any labor charges of buyer for replacement of parts, adjustments or repairs, or any other work, unless DX Engineering authorizes such charges in advance. Repairs to DX Engineering-produced items are warranted for a period of 90 days against defects in materials and workmanship. Repair or replacement is at DX Engineering's discretion.

Other Manufacturers

Most manufacturers offer their own warranties. All warranties are included with your order. Some manufacturers require their products to be sent directly to them for warranty consideration—before returning any product from another manufacturer, contact us by e-mail or by phone at 1-800-777-0703.

If you want to return any electrical products for warranty consideration, please e-mail us before shipping the items back. We will determine if a warranty claim is valid and where the part needs to be sent. You can also call 1-800-777-0703 to speak to a Customer Service representative. Any item which, in our opinion, shows evidence of being used or installed contrary to manufacturer's instructions, and/or subjected to improper handling, packaging, or shipping by the customer will not be eligible for exchange, refund, or warranty consideration. We reserve the right to charge a restocking fee or refuse any item.

We cannot accept returns on custom-ordered parts. Software or publications cannot be returned for a refund once opened.

Repairs

We can, in most cases, perform repair service on out-of-warranty DX Engineering, Butternut, COMTEK, Top Ten Devices, Hi-Z, RigExpert and TopTek branded products. The cost of repairs is based on labor rate of \$79.00 per hour, and the total cost is estimated before repair work is started. Acom, OM Power and RM Italy repairs will be conducted by our Authorized Service Providers at a cost deemed by them. Contact DX Engineering Customer Service to discuss the repairs needed and to receive shipping instructions.

Returns

DX Engineering does not have a trial or evaluation period for new equipment. However, if you're not satisfied within 10 days of receiving your purchase, contact our Customer Service/Technical Support department to discuss your options. A purchase may be returned for a full refund within 10 days of receipt providing that the original manufacturer's package is unopened, or is in as-new condition, and is undamaged. Items that you have opened and returned may be subject to a restocking or repackaging fee.

DX Engineering recommends that you insure your return shipment. After inspection and verification of the returned items' condition, DX Engineering will send the purchaser a refund or issue credit to the original payment method used for the purchase—for the full amount of the merchandise less a nominal shipping charge. Shipping charges, insurance, and oversize fees are ***not*** refundable. If it has been greater than 10 days since you received your order, the manufacturer's warranty will apply, and no returns will be accepted.

Exceptions: Any products that are personalized or special-ordered cannot be returned or exchanged.

Batteries (individual cells or battery packs), videos (any format), software, cut-to-length cable, custom-made cable assemblies, and copyrighted materials (books, publications) are ineligible for refund or exchange. Personal use items—microphones, headphones, earphones, and all clothing items—are non-returnable/non-refundable.

If a return is necessary, you must ship your return postage-paid and insured to:

DX Engineering ATTN: Returns Department
3800 Mogadore Industrial Pkwy.
Mogadore, OH 44260 USA

Include a copy of your receipt and a note explaining the reason for your return. Items without documentation may be sent back to you.

DX Engineering reserves the right to make exceptions to the above return policy depending upon specific circumstances.

Liability Statement

DX Engineering's liability for losses or damages, arising out of any cause whatsoever, is limited to full refund of the purchase price or, at our option, repair or replacement of the part(s). DX Engineering shall not be liable for any consequential or incidental damages. Some states do not allow the exclusion or limitation of incidental or consequential damages, so the above limitation or exclusion may not apply to you. Our products are not designed or intended for use in or on aircraft of any kind whatsoever. **Note: We reserve the right to limit quantities.** If you have any further questions, please send us an e-mail at DXEngineering@DXEngineering.com or contact us at 1-800-777-0703.

Expert Help is Just a Click Away!

Have questions about ordering and shipping? Looking for technical advice on your purchase?

Get fast answers at the Online Help Center. Just scan the QR code to access the Help Center at DXEngineering.com and the information you need is right at your fingertips. It's another way DX Engineering is making it easier than ever to enjoy the world's greatest hobby—Ham Radio!

- Billing & payment, product, order, shipping, returns, sales tax, and technical FAQs all in one place
- Searchable library of technical articles
- New content added regularly
- Optimized for any device—mobile, tablet or desktop
- Easy navigation and powerful keyword search



DX ENGINEERING®

Visit DXEngineering.com for the latest limited-time offers and special savings!

DX ENGINEERING

DX Engineering Digital Universal Rotator Controller

DX Engineering's Digital Universal Rotator Controller, manufactured by Green Heron, is pre-programmed for DX Engineering's RT4500HD Heavy-Duty Rotator but is adaptable for use with other directional antenna rotation systems. This highly-accurate, fully programmable and simple-to-operate unit features easy-to-read LCD display, variable-speed control, point-and-shoot or manual pushbutton operation, and more.



DXE-RT-21DXE DXE Rotator Controller \$714.99

DX ENGINEERING

Heavy-Duty Mast Clamps for Rotators

DX Engineering Heavy-Duty Mast Clamps for rotators provide a major performance upgrade over factory clamps. These direct bolt-on plated steel clamps for 2" and 3" diameter masts replace stock units installed on top of M2 Antennas OR-2800 Positioner Rotators and Yaesu G2800-DXA, G1000-DXA and G800-DXA rotators. They also work with DX Engineering's RT4500HD Heavy-Duty Rotator. The clamps improve the mast connection to the rotator and prevent mast slippage that can result with larger array setups. Pressure adjustments can be made by applying more torque to the included steel fasteners. Brand-specific bolt kits for mounting the clamps are sold separately.



DXE-RTMC-2A 2" Replacement Rotator Top Mast Clamp for RT4500HD, Yaesu, M2 \$249.99
 DXE-RTMC-3A 3" Replacement Rotator Top Mast Clamp for RT4500HD, Yaesu, M2 \$339.99
 DXE-RTMC-2A-HWK Hardware for RT4500HD/M2 OR-2800 Rotator Mast Clamp \$9.99
 DXE-RTMC-3A-HWK Hardware for Yaesu DXA Series Rotator Mast Clamp \$10.49

DX ENGINEERING

New!

Rotator Super Duty Mast Clamps

These mast clamps, which come in sizes to fit 2", 2.5", or 3" O.D. masts, are the right choice when maximum torque handling is required on aluminum and steel mast tubing for your rotator setup. These solidly built options significantly improve the connection between the rotator and the directional antenna rotating mast. The clamps mate with the DX Engineering DXE-RT4500HD Heavy-Duty Rotator and replace the clamp on the M2 OR2800 Rotator. DX Engineering highly recommends installing a 2.5" or 3" O.D. mast with its Rotator Super Mast Clamps whenever the installation of mast-mounted rotatable antennas will have a total wind load or wind exposure rating of 18 square feet or more. Kits come with two rugged aluminum clamps for the standard version and three for the heavy-duty model, stainless steel backing plates, stainless steel bolt sets, and fasteners. The clamps' special surface texture provides a secure fit that resists torque, wind, and weather. All models can be used on Rohn 45 and larger towers. Only 2" versions fit Rohn 25G towers.



Enter "DXE Super Mast Rotator" at DXEngineering.com for more details.

DXE-SDMC-2 Two SD Clamps for 2" O.D. Mast \$303.99
 DXE-SDMC-2-5 Two SD Clamps for 2.5" O.D. Mast \$439.99
 DXE-SDMC-3 Two SD Clamps for 3" O.D. Mast \$389.99
 DXE-SDMC-2HD Three SD Clamps for 2" O.D. Mast \$361.47
 DXE-SDMC-2-5HD Three SD Clamps for 2.5" O.D. Mast \$503.47
 DXE-SDMC-3HD Three SD Clamps for 3" O.D. Mast \$461.47

Rotator Replacement Potentiometer

If you're using a model 1022 or 1032 TIC Ringrotor, then Mother Nature probably makes you replace your position potentiometer a lot. Make fewer trips up the tower with this fully weather-sealed replacement pot from DX Engineering.



DXE-TICGEN-POT Rotator Replacement Potentiometer \$26.99

DX ENGINEERING

DX Engineering RT4500HD Heavy-Duty Rotator and Rotator/Controller/Clamp Combos

Extensively tested for long-term performance under conditions that far exceed normal amateur radio use, this ruggedly built and precision-engineered azimuth positioning rotator is designed to deliver flawless operation with most tower-mounted directional antenna systems. One RT4500HD purchaser summed up the rotator this way: "Best rotator on the market! This rotator delivers in every category that is important to someone looking for a well-engineered, permanent, and worry-free solution to rotating a large array." You, too, can enjoy these class-leading features:



- More than 35 square foot wind load rating (inside tower)
- Needle thrust bearings handle up to 2,000 lbs. of vertical load
- High ratio worm gear drive powered by a heavy-duty 24 VDC motor provides superior rotational torque (> 4,400 in. lbs.) and braking torque (>18,500 in. lbs.)
- Accurate within +/-0.1 degrees with high-resolution pulse counter controller
- Unique removable panel allows access to pulse counter switch without removing rotator
- Ability to set soft limits—If the antenna or mast ever slips, just reset the controller to the center of rotation and recalibrate the rotational range
- Hardened steel gears welded onto hardened steel shafts prevent slippage and shearing of key pins
- Sloped body sheds water; seals at the output shaft, intermediate plate and access panel keep moisture out; and weep holes make sure it stays dry
- Ideally sized to fit inside ROHN 25G but easily handles larger antenna systems

For complete details, enter "RT4500HD" at DXEngineering.com.

DXE-RT4500HD DXE Heavy-Duty Rotator \$2,569.99
 DXE-RT-PULSE-ASM Pulse Sensor Assembly Kit, Replacement \$114.99
 DXE-RT-SENSOR Pulse Sensor and Gasket, Replacement \$31.99
 DXE-LP20-F Cable Mount, Female 4-Pin \$20.99
 DXE-LP20-M Cable Mount, Male 4-Pin \$20.99
 DXE-ROT-MTG-HWK Mounting Hardware Kit, 4 Locking Bolts/Washers, Replacement \$9.99



Rotator/Controller/Mast Clamp Combos

Here's the perfect way to ensure simplified and worry-free rotator installation, setup, and operation. Purchase the RT4500HD as a combo with the DX Engineering plated-steel HD Mast Clamp (2" or 3") plus controller (either the microHAM ARCO or DX Engineering model). The rotator is also available as a package with mast clamp only.

DXE-RT4500HD-2 RT4500HD Rotator with 2" Mast Clamp \$2,819.98
 DXE-RT4500HD-2DX RT4500HD Rotator with 2" Mast Clamp and DXE Controller \$3,534.97
 DXE-RT4500HD-2MH RT4500HD Rotator with 2" Mast Clamp and ARCO Controller \$3,629.97
 DXE-RT4500HD-3 RT4500HD Rotator with 3" Mast Clamp \$2,909.98
 DXE-RT4500HD-3DX RT4500HD Rotator with 3" Mast Clamp and DXE Controller \$3,624.97
 DXE-RT4500HD-3MH RT4500HD Rotator with 3" Mast Clamp and ARCO Controller \$3,719.97

Prices are subject to change without notice.



Self-Contained Antenna Tracker

Looking for an easier way to enjoy the thrill of making QSOs via amateur radio satellites? Then take a good look at the Self-Contained Antenna Tracker (S.A.T.) from CSN Technologies—a device that helps Yaesu rotator and Icom rig owners get more out of satellite operating without the need to purchase a computer interface or configure satellite tracking software to work with a cable/rotator combo. Just attach the S.A.T. to a rotator and a transceiver. It works with any modern web browser on any device with no need for software, apps, or com ports. The USB-powered device natively controls Yaesu Az-El rotators and Icom satellite transceivers (through the CI-V jack) and can be interfaced with PstRotator—a software application that will support additional rotator controllers. From its main menu, users can choose from “Pass Predictions” or view the entire list of satellites, with all relevant information about each pass displayed in real-time. While tracking, the Track Panel displays essential satellite information and current antenna position information. The “Future Passes” popup displays upcoming satellites and those that are already in the sky. Users can set an audible alarm to notify them of the start of a satellite’s pass. Satellites can be graphically viewed in overhead compass style, from-the-ground style, and on a world map. Other features include built-in WiFi, built-in GPS, real-time monitoring, custom TLE list, manual and automatic TLE updates, NO/NC relay outlet, manual rotator control, transponder updates, QSO log with ADIF export, and easy OTA firmware updates. All cables included. **Enter "CSN" at DXEngineering.com for more details.**



ATN-SAT-TRACKER Self-Contained Antenna Tracker.....\$275.00

microHAM



ARCO Advanced Smart Antenna Rotator Controllers

The self-contained, intuitive-to-operate ARCO takes controlling your rotators to a heightened level. Not requiring a computer or any external devices for setup or operation, microHAM's ARCO is loaded with unique features and built to work with virtually any rotator. Its well-organized 7" touchscreen LCD (manual operation is also available) boasts a colorful great circle azimuthal map with digital heading and other functions within easy reach. The “Touch 'n Tune” feature lets you control azimuth headings while taking advantage of four radius settings, live gray line projection, multiple coloring options, and automatic day/night color schemes. The device also includes advanced damage protection; gradual speed ramps which reduce inertial stress to the rotator, antennas, and tower; Ethernet LAN and Internet remote control or local connectivity via Windows 10, macOS and Linux computers; built-in linear power supply that offers silent, interference-free operation; and compatibility with a range of absolute and relative sensors for rotator position feedback. Available with 200W or 400W power supplies. **Enter "ARCO" at DXEngineering.com for more details.**

- MOH-ARCO-115V ARCO Rotator Controller, 200W Power Supply\$809.99
- MOH-ARCO400-115V ARCO Rotator Controller, 400W Power Supply\$899.99
- MOH-ARCO-HG ARCO to Hy-Gain Rotator Adapter Cable.....\$62.99

ARXC Modules for ARCO

These modules provide expanded control and functionality of the ARCO. The ARXC LoRa is a long-range communication transceiver module operating in the 868 MHz ISM band. It converts the bidirectional RS-485 communication used by the ARCO and ARXC modules to RF data and back, enabling the wireless connection of ARXC components with the ARCO. Mounted under the antenna boom, the ARXC MAG (magnetic azimuth sensor) reports the current true azimuth of the antenna to the ARCO. The ARXC REL has four user-programmable relay outputs used for the control of various antenna and polarization switches, mast preamplifiers, and other devices which are controlled directly from the ARCO's user interface and touchscreen or through Internet remote control. The ARCO supports up to four chained ARXC modules at the same time. **Enter "ARXC" at DXEngineering.com for more details.**

- MOH-ARXC-LORA Wireless Connection of ARXC Modules to ARCO, Pair\$319.99
- MOH-ARXC-MAG Magnetic Azimuth Sensor\$159.99
- MOH-ARXC-REL Extension Module with 4 Relays, Switchable\$195.99

hy-gain

T2X Tailtwister Series II Rotator

This is the complete tower-mounted unit of the T2X rotor, with clamps and mounting hardware included. Ideal for replacing an old Hy-Gain HAM-IV rotator or for use with a third-party controller such as the Green Heron RT-21, the T2X is designed for medium communications arrays of up to 20 square feet wind load area.

- Normal operation down to -30° F
- Steel alloy ring gear good to 100,000 PSI for maximum readability
- Indicator potentiometer with ferrite beads on wires to reduce RF susceptibility
- Weatherproof AMP connector plus 8-pin plug at control box



HGN-T2XR Tailtwister Series II Rotator \$799.95

HAM-IV Rotator

The HAM-IV, known as the “Ham-4,” is the most popular rotator in the world. It is designed for medium-size communications arrays of up to 15 square feet wind load area.

- Normal operation down to -30° F
- Dual 98-ball bearing race for load bearing strength
- Electric locking steel wedge brake
- Ferrite beads on potentiometer wires reduce RF susceptibility
- Cinch plug connector plus 8-pin plug at control box—no screwdriver required
- N or S center of rotations scale on meter
- Low voltage control
- Handles masts up to 2 1/16" OD
- Power requirement: 110V, 60 Hz

HGN-HAM-IV Rotator with Controller ...\$799.95

HGN-HAM-IVR Rotator Less Controller....\$699.95



DCU-3 Digital Rotator Controller

Featuring six presets for beam headings and one-degree accuracy, this controller gives you fully automatic or manual control of your HAM Series or Tailtwister rotators. Dial in your beam heading and press the rotate button or let Ham Radio Deluxe (or similar software) control your DCU-3. Your antenna will automatically rotate to your desired direction precisely and safely. The controller's adjustable coast delay (0-10 degrees) reduces potentially damaging overshoot, and its Auto Jog function unlocks and frees the brake before rotation begins; that's great for older rotators with “sticky” brakes. Antenna bearings are displayed on a bright, blue LCD screen.

HGN-DCU-3 DCU-3 Digital Rotator Controller, 110 Vac.....\$639.95



CD-45II Metered Rotator with Friction Brake and Controller Combo Kit

The CD-45II handles 8.5 square feet when mounted inside a tower, or 5 square feet with a mast adapter.

- Bell rotator design gives complete weather protection
- Low temperature grease good to -30° F
- Dual 24-ball bearing race for load bearing support
- North center scale, dual lighted directional meter indicator
- 8-Pin plug/socket on control unit, snap-action control switches, low voltage control
- Handles masts up to 2 1/16" OD
- MSLD light duty lower mast support adapter included (not shown)
- Power requirement: 110V, 60 Hz

HGN-CD-45II Rotator and Controller Combo Kit...\$599.95



Lower Mast Support Kit

Designed to fit your HAM-IV, HAM-V, HAM-VII and T2X, this kit is perfect if you need to mount your rotator to a mast instead of a flat surface.

HGN-MSHD Lower Mast Support Kit \$159.95



Rotator Cable Connector Parts Pack

If you need to repair your T2X, HAM-V, HAM-IV, or HAM-VII Rotator's connectors, use this genuine Hy-Gain connector parts pack. It includes two receptacles, hardware and replacement pins.

HGN-870598 Rotator Connector Parts Pack \$36.99



DX ENGINEERING

Rotator Control Line Protector

Protect your control lines using this unit's eight individually shunt-protected terminals. When the voltage spikes above 82 Vdc in either polarity, the Rotator Control Line Protector automatically shunts the circuit to ground using an MOV for maximum surge protection.

The protector is housed in a weatherproof metal enclosure with an integrated mounting stud, which makes it easy to attach to a tower leg or ground rod. Terminal gaskets help prevent any moisture from entering the housing.

DXE-IS-RCT Rotator Control Line Protector\$189.99

DXE-RCT-BRKT Right Angle Flange Mounting Bracket..... \$9.99

DXE-RCT-BRKT

DXE-IS-RCT



Our catalog is only the beginning! See thousands of products at DXEngineering.com

YAESU

YSU-G-2800DXA



Heavy-Duty Rotator Systems

Yaesu makes these rotator systems for large tower mounted antennas. They consist of a rotator and an azimuth/directional controller. The rotators use a variable-voltage DC motor, which eliminates the large starting capacitor found in other systems. The motor is housed in an aluminum enclosure and is permanently lubricated to ensure years of maintenance-free operation. Each system below handles a maximum mast OD of 2.5 inches and delivers 450 degrees of antenna rotation.

The sleek controllers match the aesthetics of Yaesu's radios perfectly. They allow you to select rotating speed and antenna heading. These rotator systems incorporate an auto "slow-stop" and a "slow-start" to better handle the momentum of a large antenna, which protects both the antenna and the rotator.

Medium-Duty Rotator Systems

Perfect for smaller antennas, these systems incorporate the durable rotator design of their heavy-duty brethren. The G-450ADC rotator system provides 450 degrees of azimuth rotation in just over one minute. Mast clamp handles 1.25" to 2.5" O.D. max. Masts under 1.5" O.D. use GL-33 Mast Adjustment Plates.

Part Number	Turning Power	Wind Load Rating (Tower)	Max. Vertical Load	Price
Heavy-Duty Rotator Systems				
YSU-G-2800DXA	2,170 In.-Lbs.	32.3 Sq. Ft.	661 Lbs.	\$1,369.99
YSU-G-1000DXA	955 In.-Lbs.	23.7 Sq. Ft.	441 Lbs.	\$619.99
YSU-G-800DXA	955 In.-Lbs.	21.5 Sq. Ft.	441 Lbs.	\$489.99
Medium-Duty Rotator System				
YSU-G-450ADC	516 In.-Lbs.	10.8 Sq. Ft.	220 Lbs.	\$319.99
Medium-Duty Azimuth-Elevation Rotator System				
YSU-G-5500DC	428 In.-Lbs.	10.8 Sq. Ft.	441 Lbs.	\$759.99

DX ENGINEERING

Yaesu Rotator Cable Assemblies

DX Engineering has made it simple to hook up your Yaesu rotator with these plug-and-play cable assemblies. Featuring heavy-duty stranded copper 18 AWG wire with water-impervious and UV-resistant direct-bury jacket, cables come with installed Yaesu connectors (7-pin plug with screw-on shell and 6-pin rectangular keyed connector), eliminating the hassle of soldering wires onto tiny connector pins. Assemblies are available in a 10' length for bench testing and for regular runs in 50', 75', 100', 150', 200', 250', and 300'. They are compatible with these Yaesu rotator models: G-450A, G-450ADC, G-800DXA, G-1000DXA, G-2800DXA, G-5500A* and G-5500DC*. *Azimuth elevation rotators require two cables. Enter "DXE Yaesu Cable" at DXEngineering.com for more details.



DXE-YRC-010PE	Yaesu Rotator Cable Assembly, 10' Test Cable	\$87.99
DXE-YRC-050PE	Yaesu Rotator Cable Assembly, 50'	\$114.99
DXE-YRC-075PE	Yaesu Rotator Cable Assembly, 75'	\$141.99
DXE-YRC-100PE	Yaesu Rotator Cable Assembly, 100'	\$169.99
DXE-YRC-125PE	Yaesu Rotator Cable Assembly, 125'	\$209.99
DXE-YRC-150PE	Yaesu Rotator Cable Assembly, 150'	\$200.99
DXE-YRC-175PE	Yaesu Rotator Cable Assembly, 175'	\$226.99
DXE-YRC-200PE	Yaesu Rotator Cable Assembly, 200'	\$251.99
DXE-YRC-250PE	Yaesu Rotator Cable Assembly, 250'	\$329.99
DXE-YRC-300PE	Yaesu Rotator Cable Assembly, 300'	\$305.99

DX ENGINEERING

Rotator Accessories

DXE-UBK-HYG-1	Replacement U-Bolt (single) Kit for Hy-Gain HAM-Series/CD-45	\$12.99
DXE-UBK-HYG-2	Replacement U-Bolt (single) Kit for Hy-Gain T2X Rotor;	\$16.49



Multi-Conductor Control Wire

DXE-CW8	Control Wire, 8-Conductor	per foot \$1.40
DXE-CW8-HD	Control Wire, 8-Conductor, Heavy-Duty	per foot \$2.59
DXE-CW8-HD-1000	Control Wire, 8-Conductor, Heavy-Duty, 1,000' spool	\$1,449.95
COM-CW3	Wire, 3-Conductor	per foot \$0.49
COM-CW4	Wire, 4-Conductor	per foot \$0.85

We stock many more items than we can show. See them all at DXEngineering.com!



Universal Digital Rotor Controllers

Green Heron has added digital capabilities to its much-loved line of controllers. This new series features advanced, adaptable controls that give you unparalleled operational ability. These state-of-the-art digital controllers have variable speed control, automated PC control capability, and precision heading accuracy good to 1/10 of a degree. The controllers are fully programmable—you may modify speed, braking, limit, ramp, and a handful of other parameters.

- High-visibility LCD display with adjustable backlight brightness
- Point-and-shoot or manual push button operation plus presets
- Variable-speed control
- Start and stop ramping to reduce tower and antenna stresses
- Fully supports side mounted antennas, soft limits prevent running into tower
- Allows over-travel up to 720 degrees total
- Master/slave for stacked arrays, turn together or separately
- Easy front panel setup and setup utility software

Upgrading to the Deluxe version adds a sleek, black finish and an ultra-bright green vacuum fluorescent display.

GHE-RT-21-CDE	Universal Rotor Controller, Programmed for Hy-Gain and CDE Rotators	\$588.99
GHE-RT-21D-CDE	Deluxe Universal Rotor Controller, Programmed for Hy-Gain and CDE Rotators	\$728.99
GHE-RT-21-M2	Universal Rotor Controller, Programmed M2 Rotators	\$588.99
GHE-RT-21D-M2	Deluxe Universal Rotor Controller, Programmed M2 Rotators	\$728.99



ETX-ARS-USB-AE



ETX-ARS-USB-A

ARS-USB Antenna Rotator Control Interfaces

Imagine being able to control your rotator from your computer. Wire this interface to your existing controller, connect the console via USB to your PC and within a few minutes of setup, you'll be able to point your antennas automatically using your computer. The system is compatible with practically any tracking (satellite, logging, etc.) program and the display emulates the familiar Yaesu GS232A interface.

When used with an external 12-14 Vdc power supply, the EA4TX is also perfectly capable of operating without a computer. The unit can also be configured with its internal jumpers to make a great replacement rotator control. Software and a USB cable are included. Two versions are available: one for azimuth rotators, and the other for azimuth and elevation rotators. Your radio may require a special interface cable for the controller to work properly, see them below.

ETX-ARS-USB-A	Controller Interface, Azimuth	\$229.99
ETX-ARS-USB-AE	Controller Interface, Azimuth and Elevation	\$312.99
ETX-ARS-AZELDIN8	Cable, Azimuth and Elevation, Yaesu DIN-8	\$27.99
ETX-ARS-AZMINIDIN	Cable, Azimuth and Elevation, Yaesu Mini-DIN	\$27.99
ETX-AS2X2	Antenna Switch, 2 Input Ports into 2 Output Ports	\$89.99

Extension Cables for Yaesu Rotator Controllers

These extensions provide an easy-to-reach, quick disconnect for a long run of user-made or premade DX Engineering Yaesu Rotator Cable Assembly (DXE-YRC Series). Purchase the length you need to make it simple to disconnect the rotator control line from your Yaesu Rotator Controller. The extensions allow the controller to be repositioned and moved more easily. Plus, disconnecting the rotator control line when leaving the shack offers additional protection for the controller. Each six-conductor 18 AWG extension cable has the Yaesu standard female six-pin Molex on one end and male six-pin Molex on the other. Heat shrink on the cable ends provides strain relief and longevity. Extends for all Yaesu rotators.

DMV-YSU-EXT-5	5' Extension Cable	\$47.99
DMV-YSU-EXT-10	10' Extension Cable	\$52.99
DMV-YSU-EXT-15	15' Extension Cable	\$57.99
DMV-YSU-EXT-20	20' Extension Cable	\$62.99

The specialized DMV-YSU-PIGTAIL has female 6-pin Molex and #6 ring terminal ends exclusively for the Yaesu Azimuth-Elevation rotator controller.

DMV-YSU-PIGTAIL	3' Pigtail for Yaesu Az-El Rotator Controller	\$46.99
-----------------	---	----------------





Commercial Towers

DX Engineering is an Authorized Distributor of Rohn Commercial Tower products and accessories. We have the Rohn products you need to solve your tower structural needs—contact us for technical information and availability.

Rohn has been the world leader in tower design and manufacturing for more than six decades. We maintain one of the largest manufacturing and staging facilities in the industry—it is committed to supplying the best.

Designed for areas where land cost or availability are not an issue, Rohn G-series guyed towers provide one of the most cost effective solutions in the industry. Guyed towers install quickly and are often the choice of broadcast communications tower stations and backbone system providers.

All G-series towers are built with high strength steel tubing that is hot-dip galvanized after fabrication. Rohn's exclusive Zig-Zag® solid rod bracing provides exceptional strength.

All Rohn towers, poles and masts must be installed and dismantled by trained personnel. See the Rohn manuals and drawings for detailed information.

45G Tower and Accessories

The 45G is a true multi-use structure that provides excellent strength for applications up to 300' tall.

- Completely hot-dip galvanized after fabrication
- Built on a stable 16.75" equilateral triangle design
- High strength tubular legs joined by Zig-Zag® cross members
- Continuous solid round steel bracing
- Each section is shipped with all nuts and bolts

ROH-45G	45G Standard Section, 10'	\$371.99
ROH-45AG2	45G Top Section, 9'	\$449.99
ROH-SB45G	45G Short Base, 5'	\$177.99
ROH-BPL45G	45G Top Plate for TB3 & TB4 Bearings.....	\$413.99
ROH-BPC45G	45G Concrete Base Plate	\$197.99
ROH-GA45GD	45G Guy Bracket Assembly with Hardware.....	\$293.99

25G Tower and Accessories

The Model 25 originated at Rohn and the original still stands as the benchmark of lightweight guyed tower design quality. The 25G is available in the standard 10' section length and in a special order, UPS-shippable 7' length. The 25G uses double-bolted joints—proven to be the best method of joining tower sections for sturdiness and dependability. The 25G may be built to 190' tall.

- Completely hot-dip galvanized after fabrication
 - Built on a stable 11.25" equilateral triangle design
 - High strength tubular legs joined by Zig-Zag® cross/members, continuous solid round steel bracing
 - Each section is shipped with all required nuts & bolts
- | | | |
|------------|---|-----------------|
| ROH-25G | 25G Standard Section, 10' | \$181.99 |
| ROH-25AG2 | 25G Top Section, Accepts 2" OD Mast | \$299.99 |
| ROH-SB25G5 | 25G Short Base, 5' | \$166.99 |
| ROH-SB25G | 25G Short Base, 3.33' | \$115.99 |
| ROH-25GSSB | 25G Self-Supporting Base Plate | \$322.99 |
| ROH-BPH25G | 25G Hinged Base Plate | \$445.99 |
| ROH-SBH25G | 25G Short Hinged Base, 3.33' | \$299.99 |
| ROH-SDB25G | Drive-In Base Plate for Temporary Use..... | \$403.99 |
| ROH-GA25GD | 25G Guy Bracket Assembly with Hardware..... | \$258.99 |

Work Platform

Don't get your feet strained in the cross-bracing; install this platform on your Rohn G-series Tower and perform your repairs safely. They snap into place and let you work without strain.

ROH-WP25G	Work Platform, 23 G-Series	\$229.99
ROH-WP45G	Work Platform, 45 G-Series	\$249.99
ROH-WP55G	Work Platform, 55 G-Series	\$410.99

Erection Fixture

You probably call this a Gin Pole; it is a must-have tool to safely raise or repair your tower. The fixture is designed for 25G or 45G towers. It has the correct sheave and clamps, you supply the rope and muscle.

ROH-EF2545	Erection Fixture	\$1,525.99
------------	------------------------	-------------------

Tripod Roof Towers

ROH-TRT36	Tripod Roof Tower, 3'	\$97.99
ROH-TRT60	Tripod Roof Tower, 5'	\$122.99

Installation Accessories

Part Number	Description	Price
ROH-GAR30	Anchor Rod, Eye, Rated to 7,330 Lbs.	\$69.99
ROH-25AJBK	Replacement 25AG Joint Bolt Kit	\$10.00
ROH-45JBK	Replacement 45G Joint Bolt Kit	\$18.99
ROH-55JBK	Replacement 55G Joint Bolt Kit	\$22.00
ROH-HBUTVRO	Universal HD House Bracket, 18-36" Standoff for 25G, 45G, 55G	\$361.99

American Tower Company
Designers & Manufacturers of Communication Towers
Since 1923

Amerite 25 Series Bracket Tower Packages

American Tower has done your component-matching homework for you by building these handy 30 foot tower packages. You'll still have to add the concrete and any add-on tower accessories, but these kits are an excellent starting point. Learn more about each one's exact contents at DXEngineering.com.

TOW-AME25-K-30B3	Tower Package, with AME25-B3 Base....	\$829.99
TOW-AME25-K30BGR	Tower Package, with AME25-BGR Base;	\$809.99

Amerite Tower Sections and Components

American Tower's economical and versatile Amerite 25 Tower Series is a popular choice for many Amateur Radio applications. Depending on the antenna wind load, the 25 Series can be used in self-supporting, guyed and bracketed installations. Each tower section is hot-dip galvanized for corrosion resistance and double-bolted to create an extra-secure junction. The sections are made with steel tubing carrying a 50,000 PSI yield strength to meet ASTM 123 standards. The tower sections have 11.25" leg spacing, with 1.25" OD tubing legs.

Similar to the 25 Series, the Amerite 45 Series has wider, 16.75" leg spacing, while the 55 series has 17" leg spacing. They are both well suited to Ham use.

American Tower Company Amerite tower products are fully compatible with their respective ROHN counterparts, which means if the need arises, you have a broader pool of installation and service parts in the future.

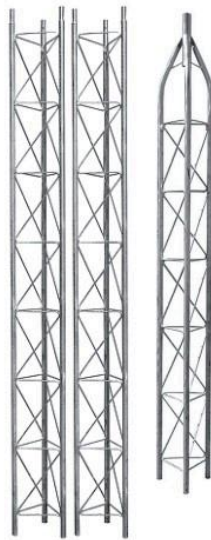

TOW-AME25-K30BGR

Tower Assistant

You spent a lot of money on your tower—don't risk damaging it with errant hammer blows. American Tower makes this tool precisely for its Amerite Tower designs. It has multiple uses, from splitting apart stubborn sections to aligning sections together. The unique leverage mechanism will save you from back and arm strain, too.

TOW-AME-TAT	Tower Assistant.....	\$175.99
-------------	----------------------	-----------------



Part Number	Description	Price
Amerite 25 Series Sections and Components		
TOW-AME25	Tower Section, 10'	\$165.99
TOW-AME25-6	Tower Section, 6'	\$189.99
TOW-AME25-T	Top Section, 9'	\$209.99
TOW-AME25-6T	Top Section, 6'	\$199.99
TOW-AME25-TRB	Top Section, Removable Mast Bushing, 9'	\$239.99
TOW-AME25-AG2E	Top Section, Tube on Top, 9.75'	\$249.99
TOW-AME25-AS	Accessory Shelf	\$99.99
TOW-AME25-B3	Base Section, 3.3'	\$119.99
TOW-AME25-GB	Guy Bracket Assembly	\$199.99
TOW-AME25-B5	Base Section, 5'	\$166.99
TOW-AME25-BGR	Base Plate, Ground/Roof Mount	\$105.99
TOW-AME25-BT	Tilt Base, 3.3'	\$169.99
TOW-AME25-BH	Base Plate, Hinged, Ground/Roof Mount	\$309.99
TOW-AME25BK	Joint Bolt Kit, Replacement Hardware	\$16.99
TOW-AME25-DIB	Drive-in Tower Base Plate	\$199.99
TOW-AME25-TBA	Hinged Base Adapter	\$329.99
TOW-AME25-WM	Wall Mount Support for Hinged Plate Mount	\$379.99
TOW-AME-DA-18	Upper Tower Bracket for AME25-WM	\$119.99
TOW-AME25-TA	Torque Arm	\$385.99
Amerite 45 Series Sections and Components		
TOW-AME45	Tower Section, 10'	\$329.99
TOW-AME45-T	Top Section, 9'	\$379.99
TOW-AME45-55-AS	Accessory Shelf	\$209.99
TOW-AME45-ABC	Anchor Base Cage	\$285.99
TOW-AME45BK	Joint Bolt Kit, Replacement Hardware	\$18.89
Amerite 55 Series Sections and Components		
TOW-AME55	Tower Section, 10'	\$439.99
TOW-AME55-B5	Base Section, 5'	\$235.99
TOW-AME55BK	Joint Bolt Kit, Replacement Hardware	\$21.89



TOW-AME25

DXEngineering.com is loaded with detailed photos, specs, videos, and more!

CARLSON *New!*

Heavy-Duty 25G Hinged Tower Base Plate

This sturdy hinged base plate shares the same bolt down and leg pattern as Rohn and American Towers 25G series towers, allowing any 25G tower to be tilted up or down for easy maintenance. Built to accurate tolerances for smooth fit and featuring all-steel construction, this USA-made base plate provides a secure foundation for your tower projects. Connecting points feature larger 1/2" hinge bolts (instead of standard 3/8") and thicker 3/8" tilt plate and gussets (instead of the usual 1/4"). Three solid-steel mounting pegs are recessed into the 36-lb. base plate for added strength. The peg layout is 11.25" center-to-center with a peg diameter of 1.060" to match the 25G leg dimension of 1.080", allowing 0.20" of clearance—a design which an engineering study found to be approximately two times stronger than competing base plates. Made for bracketed or guyed towers.



CES-HBP25G-HD 25G Hinged Tower Base Plate.....\$429.99

TBX Tower

Packaged Tower Kits and Accessories

These TBX Packaged Tower Kits eliminate guesswork and make it possible for anyone to erect a self-supporting tower. The kits include offset lattice style tower sections that create a strong, step-up design. The sections are made from contoured steel that is galvanized to resist the elements. The kits will include a rotor plate, top plate, hardware pack and a set of top-section steps. Base stubs must be ordered separately.



TBX also offers Base Hinge Kits that allow you to assemble the tower on the ground and raise it into place. The heavy-duty hinges are strong enough to handle a tower up to 64 feet. TBX Step Kits makes climbing your tower much safer and more comfortable. Both the Hinge Kits and Step Kits include all the hardware you'll need for installation.

TBX Packaged Tower Kits and accessories are available at DXEngineering.com.

Part Number	Height	Max Wind Load	Notes	Price
TBX-TBX40	40'	6 Sq. Ft.	Includes 8'/1.25" OD Mast	\$3,054.00
TBX-TBX48	48'	6 Sq. Ft.	Includes 8'/1.25" OD Mast	\$3,675.00
TBX-TBX56	56'	6 Sq. Ft.	Includes 8'/1.25" OD Mast	\$4,393.00
TBX-THBX24	24'	10 Sq. Ft.	Heavy-Duty	\$1,845.00
TBX-THBX32	32'	10 Sq. Ft.	Heavy-Duty	\$2,481.00
TBX-THBX40	40'	10 Sq. Ft.	Heavy-Duty	\$3,159.00
TBX-THBX48	48'	10 Sq. Ft.	Heavy-Duty	\$3,963.00
TBX-THBX56	56'	10 Sq. Ft.	Heavy-Duty	\$4,822.00
TBX-THDBX24	24'	18 Sq. Ft.	Extra Heavy-Duty	\$1,992.00
TBX-THDBX32	32'	18 Sq. Ft.	Extra Heavy-Duty	\$2,739.00
TBX-THDBX40	40'	18 Sq. Ft.	Extra Heavy-Duty	\$3,542.00
TBX-THDBX48	48'	18 Sq. Ft.	Extra Heavy-Duty	\$4,402.00

Tower Base Anchors

Made to fit specific-size tower sections, these hinged base anchors are required for Universal Towers self-supporting antenna packages. They feature 4' long, 0.125" diameter galvanized steel anchors and 6" hinge sleeves that make it much easier to access your antenna or raise large antennas into the open air. Anchored into a customer-supplied tower concrete foundation, these high-strength and durable bases work in perfect harmony with the rest of your tower.

UVT-B-14	Base Anchor, Fits 14" Leg Spacing....	\$166.25
UVT-B-18	Base Anchor, Fits 18" Leg Spacing....	\$166.25
UVT-B-22	Base Anchor, Fits 22" Leg Spacing....	\$241.30
UVT-B-26	Base Anchor, Fits 26" Leg Spacing....	\$294.50
UVT-B-30	Base Anchor, Fits 30" Leg Spacing....	\$424.65



Rotor Mount Shelves

Universal Towers Rotor Mounts are the perfect solution to combine your specific HyGain or Yaesu antenna rotor to your Universal Towers antenna tower. Made from strong aluminum, they're also available undrilled for mounting other rotor brands.

UVT-R11	Undrilled Rotor Mount Shelf, Fits 11" Top Section.....	\$57.00
UVT-R11-H	Rotor Mount Shelf for HyGain, Fits 11" Top Section	\$57.00
UVT-R11-Y	Rotor Mount Shelf for Yaesu, Fits 11" Top Section.....	\$57.00
UVT-R14	Undrilled Rotor Mount Shelf, Fits 14" Top Section.....	\$79.80
UVT-R14-H	Rotor Mount Shelf for HyGain, Fits 14" Top Section	\$79.80
UVT-R14-Y	Rotor Mount Shelf for Yaesu, Fits 14" Top Section	\$79.80
UVT-R-18-H	Rotor Mount Shelf for HyGain, Fits 18" Top Section	\$93.10
UVT-R-18-Y	Rotor Mount Shelf for Yaesu, Fits 18" Top Section	\$93.10



Standard-Duty and Heavy-Duty Packaged Tower Kits

Universal Towers Standard and Heavy-Duty Freestanding Aluminum Tower Packages make it simple to get the precise height (30' to 100') and wind load rating you want.

Made from high-quality aluminum, towers feature rugged, heavy-wall tubing legs and welded S-bracing. Top sections come standardized for a 2" collar. Packages with other mast collars (e.g., 1.250") are available by special order. Also included is a Universal top plate. Customers may choose to select the DX Engineering Top Plate (DXE-TOP-PLATE-DX) made for the DX Engineering Advanced Design Thrust Bearing for 2" O.D. Mast (DXE-TB300). Hardware included. Required Tower Base Anchors are sold separately. Note: Wind load ratings may be less based on U.S. Wind Loading Rating Zones. Enter "Universal Packages" at DXEngineering.com for complete details. Packages start at \$890.96

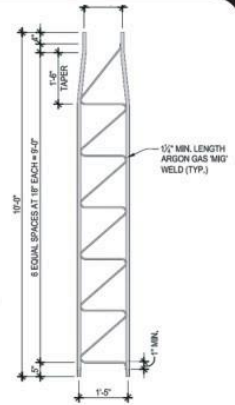

Part Number	Tower Size	Wind Load Rating, Square Feet	Required Base Anchor	Price
Standard				
UVT-12-30	30'	12	B-14	\$968.05
UVT-21-30	30'	21	B-22	\$1,133.35
UVT-23-30	30'	23	B-22	\$1,470.60
UVT-35-30	30'	34.5	B-26	\$1,693.85
UVT-7-40	40'	7	B-18	\$1,174.20
UVT-9-40	40'	9.5	B-22	\$1,316.70
UVT-12-40	40'	12	B-22	\$1,486.75
UVT-15-40	40'	15	B-22	\$1,652.05
UVT-21-40	40'	21	B-26	\$1,875.30
UVT-23-40	40'	23	B-26	\$2,212.55
UVT-7-50	50'	7	B-22	\$1,670.10
UVT-9-50	50'	9	B-22	\$1,835.40
UVT-15-50	50'	15	B-26	\$2,394.00
UVT-16-50	50'	16.5	B-26	\$2,617.25
UVT-6-60	60'	6	B-22	\$2,211.60
UVT-7-60	60'	7	B-26	\$2,412.05
UVT-9-60	60'	9	B-26	\$2,577.35
UVT-7-70	70'	7	B-26	\$3,154.00
Heavy-Duty				
UVT-HD35-40	40'	34.5	B-30	\$2,520.35
UVT-HD21-50	50'	21.1	B-30	\$2,701.80
UVT-HD16-60	60'	16.4	B-30	\$3,443.75
UVT-HD21-60	60'	21.1	B-30	\$3,528.30
UVT-HD12-70	70'	11.9	B-30	\$3,881.70
UVT-HD11-90	90'	10.8	B-30	\$5,615.45
UVT-HD4-100	100'	4.4	B-30	\$5,570.80

Packaged Tower Kits with Top Plate Made for DX Engineering Thrust Bearing

These kits contain the components (other than base anchor) to erect a durable freestanding antenna tower, including a mast collar welded with a specially drilled top plate for mounting the DX Engineering Advanced Design Thrust Bearing (DXE-TB-300) for 2" O.D. masts. Packages with other mast collars are available by special order. Each tower requires a Universal Towers base anchor with hinge sleeves, sold separately. See DXEngineering.com for complete details.

UVT-15-50-2TPD	Tower Kit, 50' High, 10 Sq. Ft. Wind Load	\$2,394.00
UVT-16-50-2TPD	Tower Kit, 50' High, 10.5 Sq. Ft. Wind Load	\$2,617.25
UVT-21-30-2TPD	Tower Kit, 30' High, 15 Sq. Ft. Wind Load	\$1,133.35
UVT-7-50-2TPD	Tower Kit, 50' High, 4 Sq. Ft. Wind Load	\$1,670.10
UVT-9-30-2TPD	Tower Kit, 30' High, 6.5 Sq. Ft. Wind Load	\$798.00
UVT-9-40-2TPD	Tower Kit, 40' High, 6.5 Sq. Ft. Wind Load	\$1,316.70
UVT-9-50-2TPD	Tower Kit, 50' High, 6.5 Sq. Ft. Wind Load	\$1,835.40
UVT-9-60-2TPD	Tower Kit, 60' High, 6.5 Sq. Ft. Wind Load	\$2,577.35

Heavy-Duty Packaged Tower Kits

UVT-HD12-80-2TPD	Tower Kit, 80' High, 11.9 Sq. Ft. Wind Load	\$4,708.20
UVT-HD21-50-2TPD	Tower Kit, 50' High, 21.1 Sq. Ft. Wind Load	\$2,701.80
UVT-HD21-70-2TPD	Tower Kit, 70' High, 21.1 Sq. Ft. Wind Load	\$4,354.80
UVT-HD9-80-2TPD	Tower Kit, 80' High, 9.29 Sq. Ft. Wind Load	\$4,230.35

Top Plate for Mounting DX Engineering Thrust Bearing

This replacement top plate for use with Universal Towers packages is drilled to mount DX Engineering Advanced Design TB300 Thrust Bearing for 2" O.D. masts.

UVT-TOP-PLATE-DX	Top Plate for Mounting TB300 Thrust Bearing	\$38.00
------------------	---	---------

DX Engineering carries equipment from more than 160 top manufacturers!

DX ENGINEERING



DXE-TB300

Advanced Design Thrust Bearings

These Advanced Design Thrust Bearings from DX Engineering improve on the standard design in two key areas. First, the ball bearings ride on an all-metal surface, not a seam like other thrust bearings, to promote a longer service life. The precision bearings are made to much tighter tolerances, eliminating the slop found in other thrust bearings.

Secondly, our Mast Thrust Bearings can handle much greater static loads than other models. Not only does that reduce stress on the rotator, it makes rotator service possible without removing your antenna—think about how much hassle, time and money that could save! They fit either a 2" or 3" OD mast and most common tower sizes from Rohn and Ameron Tower.

- DXE-TB300 Advanced Design Thrust Bearing, 2" OD Mast.....**\$265.99**
- DXE-TB400 Advanced Design Thrust Bearing, 3" OD Mast.....**\$321.99**



DX ENGINEERING



DXE-AS455G

DXE-AS25G

Tower Accessory Shelves

Ever try to pound in a one-piece rotor plate to get it to fit in the midpoint of your tower? DX Engineering's Tower Accessory Shelves are simpler to install and feature a thicker, stainless steel plate for greater stability. The DXE-AS-455G works with both 45G and 55G towers. It lets you easily mount rotators and thrust bearings thanks to its innovative multi-piece design. The shelf is bolstered by three adjustable, stainless steel corner brackets bolted to the plate. Each is secured flush to the tower with two V-bolt clamps for reduced flex.

The DXE-AS-25G is perfect for mounting a rotator to your 25G tower. This rotator plate model has formed integral brackets and includes a set of stainless steel mounting hardware. Note: AS25G and 25 tower do not accommodate internal TB300 Thrust Bearing.

- DXE-AS25G Shelf for Rohn 25G and Amerite 25**\$99.99**
- DXE-AS455G Shelf for Rohn 45G/55G and Amerite 45/55.....**\$165.99**

Mastlock Mast Anti-Rotation Assembly

DX ENGINEERING

Bid farewell to the frustration of battling unwanted mast movement when you've got work to do. Made exclusively for use with Rohn and Amerite towers, the Mastlock enables you to lock your tower mast in position and remove the rotor without having the mast slip downward. It's also perfect for keeping your antenna in place when performing maintenance. Use of two Mastlock assemblies is recommended to keep the mast centrally located. The Mastlock comes with 6061-T6 aluminum anti-rotation bracket and stainless steel V-clamps and hardware. Compatible with Rohn and Amerite 25, 45 and 55 Series towers.



DXE-MASTLOCK

- DXE-MASTLOCK Anti-Rotation Tower Assembly.....**\$55.99**

LOOS & CO. Cableware Division Guy Line Clamp Kit

Use this kit to properly terminate and secure your guy lines. Choose from two kits with six galvanized steel clamps: CP2-6P (fits 11/64", 3/16" to 7/32" OD guy lines) and CP2-8P (fits 1/4" OD guy lines). For larger size guy line, DX Engineering recommends Big Grips from Phillystran.



- LOO-CP2-6P-6 Guy Line Clamp Kit, Set of 6.....**\$7.30**
- LOO-CP2-8P-6 Guy Line Clamp Kit, Set of 6.....**\$8.45**

Heavy-Duty Galvanized Rope Thimbles

Part Number	For Cable Diameter	Overall Length	Overall Width	Price Set of 2
LOO-EY414-8-2	1/4"	2 1/4"	1 1/2"	\$4.25
LOO-EY414-10-2	5/16"	2 1/4"	1 13/16"	\$5.30
LOO-EY414-12-2	3/8"	3"	2 1/8"	\$7.39
LOO-EY414-14-2	7/16"	3 1/2"	2 3/8"	\$10.65
LOO-EY414-16-2	1/2"	3 5/8"	2 3/4"	\$12.90



Genius Clamps

If you've ever struggled to mount a horizontal cross bar to a piece of vertical tubing, then you'd probably call these "Genius!" Clamps, too. They're the ideal way to create a tower standoff to side-mount an extra antenna. These stainless steel clamps are sized for 1" to 2" OD pipe, in both horizontal and vertical orientation. Two versions are available, one for a parallel standoff, and another to create a right angle mount that's perfect for installing a vertical mast. Genius Clamp hardware is sold separately.

DX ENGINEERING



- DXE-SSGC-2P Genius Clamps, Right Angle, Pair.....**\$77.99**
- DXE-SSGC-2VP Genius Clamps, Parallel, Pair.....**\$92.99**

Genius Clamps Hardware Sets

Since we don't know your specific application, we don't include hardware. Hex bolt fasteners for Genius Clamps are available separately; select the sizes you need in the table nearby. The sets include 8 full-thread bolts or rods, 16 nuts, 8 flat washers and 8 split washers. The thread is 5/16"-18.

Part Number	Bolt Length	Price
DXE-SSGCBOLT-4	4"	\$13.99
DXE-SSGCBOLT-4-5	4.5"	\$17.99
DXE-SSGCBOLT-5	5"	\$18.29
DXE-SSGCBOLT-5-5	5.5"	\$19.49
DXE-SSGCBOLT-6	6"	\$19.99
DXE-SSGCBOLT-6-5	6.5"	\$22.49

Lightning Rod Mounting Solutions from DX Engineering

DX ENGINEERING

These specially designed clamps are the best way to affix a lightning rod to the top of your tower. The heavy-duty, stainless steel assemblies are rugged enough to handle severe weather and will resist corrosion for years of outdoor use. DX Engineering Lightning Rod Mast Mounts will work with lightning rods from 5/8"-3/4" in diameter, and will clamp to any 2"-3" OD mast. The mounting hardware is sold separately; see the table below.

- DXE-LRMM Lightning Rod Mast Mounts.....**\$75.99**

Lightning Rod Mast Mount Fasteners - Here are the complementing fastener kits for the DX Engineering Lightning Rod Mast Mounts. Each set contains 8 threaded rods with 32 matching hex nuts, plus 16 flat and 16 lock washers. Choose your kit based on the OD of the mast you're mounting to.

Part Number	Bolt Length	For Mast OD	Price
DXE-LRMM-FAST7	7"	2"	\$33.99
DXE-LRMM-FAST7-5	7.5"	2.5"	\$29.99
DXE-LRMM-FAST8	8"	3"	\$50.99

Lightning Rod Kits - If you want a complete lightning rod solution for your tower, we've built these combos that bundle together our Lightning Rod Mast Mounts, the appropriate Fastener kit, plus an Erico Lighting Rod. If you have questions on how to properly safeguard your tower from lightning strikes, call us—we'll be happy to help.



DX ENGINEERING

Bearing Bypass Ground Kits

When lightning hits your tower, the first place that massive energy jumps through is the mast thrust bearing. That's bad news for the thrust bearing but worse news for you. Replacing it means removing your antennas—a process that is both time-consuming and really, really expensive.



These kits use heavy-gauge, flexible cable to safely guide lightning energy away from the thrust bearing and down your tower to ground. They're easy to install and cheap insurance against a costly repair.

- DXE-BBGK-2-25-P Kit for 2" Mast and Rohn 25G/45G Tower Leg.....**\$205.23**
- DXE-BBGK-3-25-P Kit for 3" Mast and Rohn 25G/45G Tower Leg.....**\$220.23**
- DXE-BBGK-3-55-P Kit for 3" Mast and Rohn 55G Tower Leg.....**\$223.73**

LOOS & CO. Cableware Division Professional Guy Line Tension Gauges

Avoid serious safety issues by ensuring that your guy lines are properly tensioned. These gauges offer professional-level accuracy and are easy to use. They'll gauge the tension of your tower guy lines, large tent supports and sailboat rigging. The gauges accept lines from 3/32" to 3/8" OD.

- LOO-PT-1 3/32"-5/32" Tension Gauge, 70-800 Lb. Range.....**\$145.99**
- LOO-PT-2 3/16"-1/4" Tension Gauge, 180-2,000 Lb. Range.....**\$145.99**
- LOO-PT-3 1/4"-3/8" Tension Gauge, 550-4,500 Lb. Range.....**\$285.99**



Check out our YouTube channel for in-depth tech tips and product demos!

Phillystran® Non-Metallic Tower Guy Line



These insulator-free, non-metallic guys have been protecting the towers of knowledgeable amateur radio operators since 1973. Following their introduction, Phillystran Guy Lines have been installed on commercial broadcast towers worldwide. Electrically transparent Phillystran tower guys are protected by an extruded jacket, providing excellent resistance to weather and abrasion, along with a host of other benefits.



- Complete isolation of tower-guy system from the antenna field
- Improved signal coverage, eliminating distortion caused by re-radiated signals
- Quick, easy, maintenance-free tower installations
- A neat tower appearance, free of corroded steel guys and troublesome ceramic insulators (solving arcing white noise issues, too)
- No need to calculate guy lengths to avoid guy line resonance
- No insulators required
- None of the stretching or aging problems associated with conventional synthetic ropes
- No more zapping, snapping and crackling across porcelain insulators

PHI-HPTG-1200I	4mm Dia., 1,200 Lbs. Break Strength.....	per foot \$0.99
PHI-HPTG-2100I	6mm Dia., 2,100 Lbs. Break Strength.....	per foot \$1.39
PHI-HPTG-4000I	8mm Dia., 4,000 Lbs. Break Strength.....	per foot \$1.99
PHI-HPTG-6700I	9mm Dia., 6,700 Lbs. Break Strength.....	per foot \$2.75
PHI-HPTG-11200I	11mm Dia., 11,200 Lbs. Break Strength.....	per foot \$3.75

Phillystran® Big Grip Dead-Ends

Phillystran has answered the call for field-installable, non-metallic tower-guy systems with HPTG-I and PLP Big Grip Dead-Ends. Phillystran Big Grip Dead-Ends have a variety of unique features:

- Grip designed to match rope twist direction (RHL)
- Special-sized wires for ease of application
- Galvanized steel and "C" coat construction
- Color-coded for ease of identification
- Longer length to match Phillystran's high performance forged steel galvanized wire rope clips are recommended for the small PHI-HPTG-1200I Guy Line



PHI-PLP-2738	Blue Tag, Use with HPTG-2100I Guy Line.....	\$15.99
PHI-PLP-2739	Yellow Tag, Use with HPTG-4000I Guy Line.....	\$20.99
PHI-PLP-2755	Red Tag, Use with HPTG-6700I Guy Line.....	\$29.99
PHI-PLP-2558	Black Tag, Use with HPTG-11200I Guy Line.....	\$35.99

DX ENGINEERING Vinyl End Caps for Phillystran® Guy Line

Heavy-duty vinyl to cover and protect cut cable ends.



DXE-H166	Use with HPTG-1200I Guy Line, Pack of 20.....	\$12.99
DXE-H165	Use with HPTG-2100I Guy Line, Pack of 20.....	\$12.99
DXE-H164	Use with HPTG-4000I Guy Line, Pack of 20.....	\$12.99
DXE-H142	Use with HPTG-6700I Guy Line, Pack of 20.....	\$12.99
DXE-H204	Use with HPTG-11200I Guy Line, Pack of 20.....	\$13.99

DX ENGINEERING Insulator and Bent Pin Shackle Kits

These kits are the ideal way to secure your guy lines to your tower, while protecting your antenna from RF noise generated by those guy lines. They feature porcelain insulators and galvanized steel shackles. Each shackle accepts Big Grip dead ends and is compatible with both metallic and non-metallic guy lines. The kits include three insulators and three shackles.



DXE-INS-P1	Kit, 504-Style Insulators, 12,000 Lb. Break Strength.....	\$261.98
DXE-INS-P2	Kit, 502-Style Insulators, 10,000 Lb. Break Strength.....	\$253.98

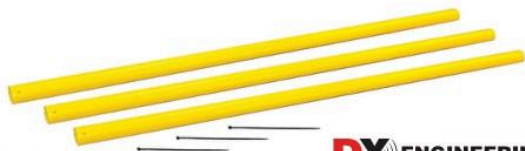

Guy Line Guards

Here's another smart way to protect your ham radio investment. Guy Line Guards from DX Engineering can be used on towers to prevent damage to coaxial cable rotator loops that rub directly on metal guy lines or dead ends. The high-visibility yellow poly plastic guy line guard tubes are 46" long and come split lengthwise for easy installation on existing coaxial cable. A hole in each tube lets you secure it firmly in place with a zip-tie. The brightly-colored guards may also be mounted at the bottom of guy lines to warn people that the guy line is present.

DXE-GLG4-3P	Guy Line Guards, Set of 3.....	\$35.99
-------------	--------------------------------	----------------



DX ENGINEERING



Phillystran Tail Kits

Using a steel tail to terminate your non-metallic guy line is a smart way to protect it from damage—whether its from vandals, brush fires, lawn mowers, fertilizers or ambitious rodents. As recommended by Phillystran, DX Engineering assembled kits to make it easy to install or upgrade your guying system. The kits include 12 feet of galvanized steel guy line, a porcelain strain insulator, Big Grips (for the dead end only), a heavy-duty thimble and cable ties. You supply the guy line and appropriate Big Grip. The kits below are designed for three guy lines. Find individual sets at DXEngineering.com.

Part Number	Guy Line Diameter	Insulator Strength Lbs.	Breaking Strength Lbs.	Price
DXE-PT-4000-3P	0.187"	10,000	3,990	\$201.99
DXE-PT-6700-3P	0.250"	10,000	6,650	\$229.99
DXE-PT-11200-3P	0.313"	12,000	11,200	\$239.99



The connection you can count on.

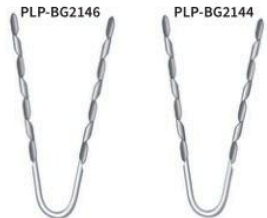

Dead End and End Sleeve Big Grips

DX Engineering offers Big Grip Dead Ends and End Sleeves from Preformed Line Products (PLP), a worldwide designer and manufacturer that has been relied upon by major corporations as well as Amateur Radio enthusiasts since 1947. The company's strong and reliable galvanized steel Big Grip Dead Ends are available in multiple sizes to precisely fit your tower guy line installation. Choose PLP Big Grip End Sleeves to finish the application of a dead end on a guy line. The End Sleeves, also known as "Grip Clips" or "Ice Clips," secure the grip tail ends and prevent them from opening or unraveling from ice intrusion or vibration.

Big Grip Dead Ends

PLP-BG2142	Big Grip Dead End for 3/16" EHS Guy.....	\$10.29
PLP-BG2144	Big Grip Dead End for 1/4" EHS Guy.....	\$11.99
PLP-BG2146	Big Grip Dead End for 5/16" EHS Guy.....	\$14.99
PLP-BG2147	Big Grip Dead End for 3/8" EHS Guy.....	\$19.99
PLP-BG2115	Big Grip Dead End for 1/2" EHS Guy.....	\$39.99
PLP-BG2116	Big Grip Dead End for 9/16" EHS Guy.....	\$59.99
PLP-BG2111	Big Grip Dead End for 5/8" EHS Guy.....	\$92.99

Big Grip End Sleeves

PLP-GC-65303	Big Grip End Sleeve for 3/16" Dead End.....	\$6.59
PLP-GC-65136	Big Grip End Sleeve for 1/4" Dead End.....	\$7.19
PLP-GC-65128	Big Grip End Sleeve for 5/16" Dead End.....	\$7.59

Tower Guy Line Galvanized Turnbuckles

Don't trust the integrity of your antenna towers to anything but top-notch gear. These hot-dip galvanized heavy-duty cast steel turnbuckles have threaded casings with Eye/Jaw or Jaw/Jaw screw bolts at opposite ends to provide tension adjustments for metallic or non-metallic guy line tower support systems. They are available in load capacities from 1,200 to 5,200 lbs. and break strengths from 6,000 to 26,000 lbs., allowing you to select the turnbuckle best suited to meet and/or exceed your tower's requirements. Depending on model, turnbuckles have adjustment maximums of 6" or 12". Sold individually.



DMV-3-8TBE-J	Turnbuckle, 3/8", Eye/Jaw, 1,200 Lb. Load.....	\$35.99
DMV-3-8TBE-J-J	Turnbuckle, 3/8", Jaw/Jaw, 1,200 Lb. Load.....	\$34.99
DMV-1-2TBE-J	Turnbuckle, 1/2", Eye/Jaw, 2,200 Lb. Load.....	\$59.99
DMV-1-2TBE-J-J	Turnbuckle, 1/2", Jaw/Jaw, 2,200 Lb. Load.....	\$49.99
DMV-5-8TBE-J	Turnbuckle, 5/8", Eye/Jaw, 3,500 Lb. Load.....	\$65.99
DMV-5-8TBE-J-J	Turnbuckle, 5/8", Jaw/Jaw, 3,500 Lb. Load.....	\$41.99
DMV-3-4TBE-J	Turnbuckle, 3/4", Eye/Jaw, 5,200 Lb. Load.....	\$55.99
DMV-3-4TBE-J-J	Turnbuckle, 3/4", Jaw/Jaw, 5,200 Lb. Load.....	\$59.99

For new hams, check out our Getting Started HT, Mobile, and Base Radio Packages!



15, 25, and 46 Foot Telescoping Fiberglass Tubing Mast Kits

Perfect for operating on the go or testing antenna projects in your backyard, the kits come with finely finished, high-quality pultruded fiberglass tubing featuring nominal 0.120" wall thicknesses, offering strength and durability. Depending on the kit, tubing is collapsible to either 4' or 7.5' for easy storage, convenient loading in a vehicle, and reduced shipping costs. Heavy-duty model comes with 3" O.D. base section.

- Custom-made tubing
- Smooth telescoping
- Neutral light gray color
- Includes DX Engineering cam lock clamps, adjustment wrench and vinyl cap

DXE-TFK15	15' Telescoping Tubing Kit.....	\$95.98
DXE-TFK25	25' Telescoping Tubing Kit.....	\$162.98
DXE-TFK46	46' Telescoping Tubing Kit.....	\$193.98
DXE-TFK46-HD	46' Heavy-Duty Telescoping Tubing Kit.....	\$248.98



Guy Rings

You can use DX Engineering's finely engineered Guy Rings to secure your rope guys and stabilize your DX Engineering, Hustler or other aluminum vertical antenna. They're also great for our Telescoping Fiberglass and Aluminum Tubing Kits.

These guy rings are super strong, virtually impervious to the elements and fit 0.75", 1.0", 1.25", 1.50" and 2.0" OD tubing. For all the specs, please visit DXEngineering.com.

DXE-GR-2P	Guy Rings, Set of 2.....	\$5.29
DXE-GR-4P	Guy Rings, Set of 4.....	\$10.29
DXE-GR-5P	Guy Rings, Set of 5.....	\$9.29



Shown with optional parts.

HF Antenna Mounting Heavy-Duty Pivot Base

You don't have to call a buddy—this base lets you raise your antenna without asking for help. It's perfect for both monoband and multi-band HF vertical antennas. In fact, this is the same base supplied with many of DX Engineering's vertical antenna kits.

Made with stainless steel components and extra-strong Extren® insulated channels, the DX Engineering Pivot Base is an excellent HF antenna mounting solution. Visit DXEngineering.com to see exact installation parameters.

DXE-VA-PIVOT-3	Pivot Base, for 3" OD Base Tubing.....	\$713.99
----------------	--	-----------------

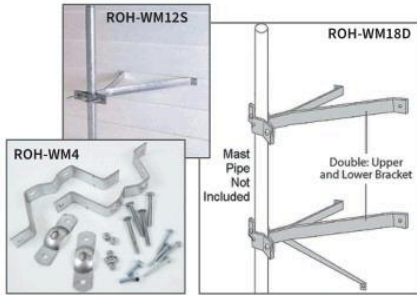

Wall Mounts

Take advantage of rigid walls; use a Rohn Wall Mount to install your antenna. These mounts include all the clamps and hardware you need, just add your mast and you're ready to go. They handle .875"-2.75" OD tubing and hold the mast away from your wall. They're hot-dip galvanized to resist corrosion.



Part Number	Wall Clearance	Brackets Included	Price
ROH-WM4	3"	2	\$43.99
ROH-WM12S	12"	1	\$50.99
ROH-WM18S	18"	1	\$52.99
ROH-WM18D	18"	2	\$96.99
ROH-WM24S	24"	1	\$54.99
ROH-WM24D	24"	2	\$98.99



Telescoping Aluminum Antenna Kit

- Eleven telescoping sections from 2" to 7/8" OD
- Stainless steel element clamps

DXE-ATK65A	Telescoping Aluminum Antenna Kit.....	\$459.99
DXE-VE-BASE	Vertical Antenna Fixed Base Assembly, Insulated.....	\$116.99
DXE-VA-BASE	Vertical Antenna Tilt Base Assembly, Insulated.....	\$202.99

DXE-VA-BASE



Telescoping Masts

Rohn telescoping masts are available in 28', 34', 36' and 43' nominal heights. They are pre-galvanized for corrosion protection and come assembled with hardware. All masts must be guyed or bracketed; installation should be done by experienced professionals. Telescoping masts are not recommended for commercial, CB or beam antenna installations. Truck Freight on "H" Series.

ROH-H30	28' Telescoping Mast.....	\$131.99
ROH-H40	36' Telescoping Mast.....	\$191.99
ROH-H50	43' Telescoping Mast.....	\$245.99
ROH-9H50	34' Telescoping Mast.....	\$261.99

Telescopic Mast Ground Mount

Built for your Rohn H and 9H (or any other 1.25"-1.5" telescopic mast), simply drive this ground mount into the soil, add your guy lines and get on the air.

ROH-GTMBL	Ground Mount.....	\$80.99
-----------	-------------------	----------------



Heavy-Duty 4130 Chromoly Steel Masts

Serious antenna builders know you can't compromise on anything. With that in mind, DX Engineering offers you super-strong masts perfectly suited to Amateur Radio applications. Available in 2 or 3 inch outside diameters, these galvanized steel masts have a 1/4" wall thickness for extra rigidity. The masts have a yield stress rating over 100,000 psi, a minimum Rockwell hardness of 96, and a galvanized coating that meets ASTM A123/M specifications.

They are sold in 11' or 22' lengths; DX Engineering will help arrange low-cost truck freight shipping and ensure that the ordering process will go smoothly. Call 800-777-0703 to get started and use the online Mast Load Estimator tool at DXEngineering.com to test your proposed installations.

Heavy-Duty 4130 Chromoly Steel Mast

DXE-ST200CM-11	11', 2" OD.....	\$405.99
DXE-ST300CM-11	11', 3" OD.....	\$555.99
DXE-ST200CM-22	22', 2" OD.....	\$751.99
DXE-ST300CM-22	22', 3" OD.....	\$999.99



Antenna Boom Tubing Kits

Whether you're replacing a 3" boom or building a new one, here's the ideal solution for antenna boom projects. For 48' booms, the ABT3-48 kit comes with two 24' pieces of 3" x 0.120" wall tubing and one 24' long, 2.715" x 0.132" wall splice insert tube. The ABT3-24R comes with one 24' piece of 3" x 0.120" wall tubing and one 24' long, 2.715" x 0.132" wall splice insert tube. This can be used to create a very strong 24' double wall boom, or an extended 36' assembly (cutting required). These high-strength, reinforced antenna boom tubes are suitable for Yagis and log periodics from 40 through 10 meters. Pieces require user drilling and fitting. Joining bolts are included. Other hardware must be user supplied.

DXE-ABT3-24R	Antenna Boom Tubing Kit, Up to 36'.....	\$696.99
DXE-ABT3-48	Antenna Boom Tubing Kit, 48', 24' OD Splice.....	\$730.99
DXE-ABT3-48S	Antenna Boom Tubing Kit, 48', 8' OD Splice.....	\$601.99



Yagi Support Bracket Kit

The Diamond Antenna Yagi Support Bracket Kit is used for side mounting a Diamond Antenna VHF or UHF Yagi for vertical polarization. Vertical positioning on a metal mast disturbs the radiation pattern. This boom support mounting bracket mounts onto a mast of up to 1.750" diameter. Due to cross-polarization effects, side mounting in the vertical position dramatically improves the performance of these Diamond beams for FM operations. This support is not required for the horizontal mounting of Diamond Yagis for horizontal polarization.

Want to go vertical for FM repeater or mobile contacts? Order a Diamond Antenna Yagi Support Bracket Kit from DX Engineering and see the difference correct polarization can make.

DMN-KB430	Yagi Support Bracket Kit.....	\$25.99
-----------	-------------------------------	----------------



New!

Most in-stock parts ship throughout the contiguous US in just 1-2 days!

DX ENGINEERING®

Aluminum Tubing

Custom-made for DX Engineering, this high strength Type 6063-T832 seamless drawn aluminum tubing is available in 3 and 6 foot lengths. Type 6063 alloy provides good resistance to general corrosion, including stress corrosion cracking and has excellent surface appearance.

Use the 3 foot lengths for fast taper, low-wind resistance applications. The 6 foot slow taper lengths afford the greatest bandwidth. Most sizes are slit on one end for use with DX Engineering Stainless Steel Element Clamps. If unslit ends are required for your application, merely insert the slit end into the next larger size in the stack and use your own attachment method.

The 0.058 inch wall tubing is available in 1/8 inch increments from 3/8 inch to 2 1/8 inch OD. It is ideal for a free, yet solid telescoping fit from size to size for vertical or Yagi elements. Some larger sizes are available in 0.120 inch wall, 6061-T8 aluminum, which assures maximum strength at very long assembly lengths.

- High-strength Type 6063 seamless aluminum tubing—drawn, not extruded
 - Ideal for telescoping antenna elements, support masts and booms
 - Available in unslit and pre-slit lengths
 - Use DX Engineering Stainless Steel Element Clamps to assemble lengths of slit tubing
- Stainless steel element clamps for exact tubing sizes are available at DXEngineering.com.

Aluminum Tubing, No Slit

Part Number	OD	Wall	Length	Each
DXE-AT1240	0.375"	0.058"	3 Foot	\$11.49
DXE-AT1494	0.500"	0.058"	3 Foot	\$12.49
DXE-AT1495	0.625"	0.058"	3 Foot	\$12.99
DXE-AT1496	0.750"	0.058"	3 Foot	\$12.49
DXE-AT1497	0.875"	0.058"	3 Foot	\$12.99
DXE-AT1498	1.000"	0.058"	3 Foot	\$13.49
DXE-AT1499	1.125"	0.058"	3 Foot	\$13.99
DXE-AT1500	1.250"	0.058"	3 Foot	\$14.49
DXE-AT1501	1.375"	0.058"	3 Foot	\$14.99
DXE-AT1502	1.500"	0.058"	3 Foot	\$15.49
DXE-AT1503	1.625"	0.058"	3 Foot	\$15.99
DXE-AT1504	1.750"	0.058"	3 Foot	\$16.49
DXE-AT1505	1.875"	0.058"	3 Foot	\$16.99
DXE-AT1506	2.000"	0.058"	3 Foot	\$17.99
DXE-AT1255	2.000"	0.120"	3 Foot	\$31.99
DXE-AT1507	2.125"	0.058"	3 Foot	\$18.99
DXE-AT1189	0.375"	0.058"	6 Foot	\$12.49
DXE-AT1480	0.500"	0.058"	6 Foot	\$13.49
DXE-AT1481	0.625"	0.058"	6 Foot	\$13.99
DXE-AT1482	0.750"	0.058"	6 Foot	\$14.99
DXE-AT1483	0.875"	0.058"	6 Foot	\$17.49
DXE-AT1484	1.000"	0.058"	6 Foot	\$18.99
DXE-AT1485	1.125"	0.058"	6 Foot	\$20.99
DXE-AT1486	1.250"	0.058"	6 Foot	\$21.99
DXE-AT1487	1.375"	0.058"	6 Foot	\$22.99
DXE-AT1488	1.500"	0.058"	6 Foot	\$23.99
DXE-AT1489	1.625"	0.058"	6 Foot	\$25.99
DXE-AT1490	1.750"	0.058"	6 Foot	\$26.99
DXE-AT1491	1.875"	0.058"	6 Foot	\$28.99
DXE-AT1492	2.000"	0.058"	6 Foot	\$30.99
DXE-AT1493	2.125"	0.058"	6 Foot	\$31.99



Aluminum Tubing with One End Slit

Part Number	OD	Wall	Length	Each
DXE-AT1241	0.500"	0.058"	3 Foot	\$17.99
DXE-AT1242	0.625"	0.058"	3 Foot	\$18.99
DXE-AT1243	0.750"	0.058"	3 Foot	\$19.49
DXE-AT1244	0.875"	0.058"	3 Foot	\$20.49
DXE-AT1245	1.000"	0.058"	3 Foot	\$20.99
DXE-AT1246	1.125"	0.058"	3 Foot	\$21.99
DXE-AT1247	1.250"	0.058"	3 Foot	\$22.49
DXE-AT1248	1.375"	0.058"	3 Foot	\$22.99
DXE-AT1249	1.500"	0.058"	3 Foot	\$23.49
DXE-AT1250	1.625"	0.058"	3 Foot	\$23.99
DXE-AT1251	1.750"	0.058"	3 Foot	\$24.49
DXE-AT1252	1.875"	0.058"	3 Foot	\$24.99
DXE-AT1253	2.000"	0.058"	3 Foot	\$25.99
DXE-AT1205	0.500"	0.058"	6 Foot	\$19.99
DXE-AT1206	0.625"	0.058"	6 Foot	\$21.49
DXE-AT1207	0.750"	0.058"	6 Foot	\$22.49
DXE-AT1208	0.875"	0.058"	6 Foot	\$24.49
DXE-AT1209	1.000"	0.058"	6 Foot	\$25.99
DXE-AT1210	1.125"	0.058"	6 Foot	\$27.99
DXE-AT1211	1.250"	0.058"	6 Foot	\$29.99
DXE-AT1212	1.375"	0.058"	6 Foot	\$30.99
DXE-AT1213	1.500"	0.058"	6 Foot	\$31.99
DXE-AT1214	1.625"	0.058"	6 Foot	\$33.99
DXE-AT1215	1.750"	0.058"	6 Foot	\$34.99
DXE-AT1216	1.875"	0.058"	6 Foot	\$35.99
DXE-AT1217	2.000"	0.058"	6 Foot	\$37.99
DXE-AT1218	2.125"	0.058"	6 Foot	\$38.99

6061-T8 Aluminum Tubing, Heavy Wall, No Slit Ideal for Booms and HD Element Designs.

Part Number	OD	Wall	Length	Each
DXE-AT1311	1.500"	0.120"	6 Foot	\$61.99
DXE-AT1312	1.750"	0.120"	6 Foot	\$65.99
DXE-AT1313	2.000"	0.120"	6 Foot	\$79.99
DXE-AT1314	2.250"	0.120"	6 Foot	\$82.99
DXE-AT1315	2.500"	0.120"	6 Foot	\$89.99
DXE-AT1316	2.750"	0.120"	6 Foot	\$96.99
DXE-AT1317	3.000"	0.120"	6 Foot	\$105.99



DXE-UT-KIT-DBR



Pipe and Tube Deburring Tools

If you're building a tower, mast or beam antenna, these tools will be worth their weight in gold. They make the tedious deburring process much easier. These tools smooth the rough edges on the inside and outside of your telescoping aluminum, fiberglass, copper, steel or plastic pipe and tubing, assuring a smooth surface when joined with another section.

You can purchase each tool separately or together in a kit that includes both deburring tools, a small hand deburring tool, half-round file and a carrying case.

- DXE-UT-KIT-DBR Deburring Tool Kit.....\$88.99
- DXE-UT-2125 Deburring Tool, for .375" to 2.125" OD Tubing.....\$24.99
- DXE-UT-3500 Deburring Tool, for 1.875" to 3.5" OD Tubing.....\$29.99



DXE-VC-0612 Shown Installed

DXE-VPC-0677 Shown Installed

Vinyl End Caps

Keep moisture out of open tubes to prevent rust or, worse yet, frozen pipes. These UV-rated black vinyl end caps are also great for sealing your booms or Yagi elements.

Part Number	Length	Tubing Size (OD)	Quantity	Price
DXE-VC-0125	1.000"	0.125"	20	\$9.99
DXE-VC-0250	0.500"	0.250"	20	\$9.99
DXE-VC-0375	0.500"	0.375"	20	\$9.99
DXE-VC-0437	0.500"	0.437"	20	\$12.99
DXE-VC-0500	0.500"	0.500"	20	\$12.99
DXE-VC-0625	1.000"	0.625"	20	\$12.99
DXE-VC-0750	1.000"	0.750"	20	\$12.99
DXE-VC-0875	1.000"	0.875"	10	\$12.99
DXE-VC-1000	1.000"	1.000"	10	\$12.99
DXE-VC-1125	1.000"	1.125"	10	\$13.99
DXE-VC-1250	1.000"	1.250"	10	\$13.99
DXE-VC-1375	1.000"	1.375"	8	\$11.99
DXE-VC-1500	1.000"	1.500"	6	\$8.99
DXE-VC-1625	1.000"	1.625"	4	\$9.49
DXE-VC-1750	1.000"	1.750"	4	\$9.49
DXE-VC-1875	1.000"	1.875"	4	\$9.99
DXE-VC-2000	1.000"	2.000"	2	\$9.99
DXE-VC-2250	1.000"	2.250"	2	\$7.99
DXE-VC-3000	1.000"	3.000"	2	\$10.99

DXE-VPC-0677 caps are ideal for PL-259 connectors and the DXE-VC-0612 for SO-239 connectors.

- DXE-VPC-0677 1.437" 0.677" 20 \$9.99
- DXE-VC-0612 0.500" 0.612" 20 \$12.99

SS-30™ Pure Copper Anti-Seize Lubricant

Use Jet-Lube on your taps, lugs, aluminum tubing joints, copper grounding straps, clamps, hardware and anywhere you need excellent conductivity.

- JTL-12555 Jet-Lube, 0.25 Lb. Brush-Top Can.....\$31.99
- JTL-12502 Jet-Lube, 0.50 Lb. Brush-Top Can.....\$42.99
- JTL-12504 Jet-Lube, 1.0 Lb., Brush-Top Can.....\$64.99



Adjustable Length Deburring Tool

- DXE-22600 Deburring Tool.....\$20.99
- DXE-22110 Replacement Blades for Aluminum/Steel, Pack of 10.....\$17.99



Join our crew on Facebook for news and exclusive deals!



Genius Clamps

If you've ever struggled to mount a horizontal cross bar to a piece of vertical tubing, then you'd probably call these "Genius!" Clamps, too. They're the ideal way to create a tower standoff to side-mount an extra antenna. These stainless steel clamps are sized for 1" to 2" OD pipe, in both horizontal and vertical orientation. Two versions are available, one for a parallel standoff, and another to create a right angle mount that's perfect for installing a vertical mast. Genius Clamp hardware is sold separately.

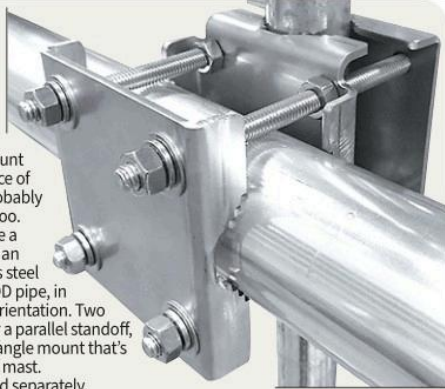

DXE-SSGC-2P	Genius Clamps, Right Angle, Pair	\$77.99
DXE-SSGC-2VP	Genius Clamps, Parallel, Pair	\$92.99
Stainless Steel Genius Clamp hardware		
DXE-SSGCBOLT-6-5	6.5" Bolt Length, 5/16"-18 Thread, Set of 8	\$22.49
DXE-SSGCBOLT-6	6" Bolt Length, 5/16"-18 Thread, Set of 8	\$19.99
DXE-SSGCBOLT-5-5	5.5" Bolt Length, 5/16"-18 Thread, Set of 8	\$19.49
DXE-SSGCBOLT-4-5	4.5" Bolt Length, 5/16"-18 Thread, Set of 8	\$17.99
DXE-SSGCBOLT-5	5" Bolt Length, 5/16"-18 Thread, Set of 8	\$18.29
DXE-SSGCBOLT-4	4" Bolt Length, 5/16"-18 Thread, Set of 8	\$13.99



Hairpin-Style Driven Element Matching Kits

Most Yagi antennas have a feedpoint impedance of about 25 Ω. Obviously, this will not allow a connection to a 50 Ω feedline without a serious mismatch. There are various ways to match the driven element to the feedline successfully. Gamma, T-Match and the Hairpin (aka Beta Match) are favorites.

The Gamma match is an unbalanced system that typically distorts the antenna pattern. The T-Match is basically two Gamma match systems on either side of the boom, which corrects the imbalance but is a mechanical nightmare and difficult to tune correctly.

The DX Engineering Hairpin is balanced and easy to tune. It has the correct electrical and mechanical design to allow it to be easily installed and tuned in 10 minutes, and has enough capacity for almost any Yagi design. Complete your installation with elements, element brackets and bracket hardware, available separately.

For use with BEB-2 Insulated Boom-to-Element Brackets

DXE-HMS-1P Hairpin Matching Syst., 10-30 MHz, Fits 2" Boom **\$71.99**

For use with BEB-3 Insulated Boom-to-Element Brackets and an SEI Split Element Insert

DXE-HMS-2P Hairpin Matching Syst., 24.9-54 MHz, Fits 1-1.75" Boom..... **\$87.99**

For use with BEB-1 Insulated Boom-to-Element Brackets

DXE-HMS-4P Hairpin Matching Syst., 10-30 MHz, Fits 3" Boom **\$71.99**



Boom Support Parts

As antennas become larger, booms become longer, or the wind speed becomes higher, our 3 inch Boom Support Systems will keep the boom straight. Your antenna will look better, perform better and survive storms in better shape. Many of the individual pieces in these systems are available separately so you can design and build your own support systems.

2 Inch Boom Support Components

DXE-ATBB-2 2" Boom Bracket..... **\$11.99**

3 Inch Dual Boom Support System and Components

DXE-ATBB-3 3" Boom Bracket..... **\$12.99**

Turnbuckles

DXE-TRBK-14 Turnbuckle, 5.25" Retracted, 7.375" Extended..... **\$8.49**

DXE-TRBK-15 Turnbuckle, 6.5" Retracted, 9.125" Extended..... **\$10.49**



Insulated Boom-to-Element Brackets

DX Engineering offers insulated boom-to-element brackets to fit 1.75 inch, 2 inch and 3 inch OD booms. The non-metallic brackets electrically insulate the elements from the boom, which virtually nullifies the shortening effect that the boom and the normal metallic boom-to-element plates have on element length. This means the element lengths calculated through antenna design programs like YO, EZNEC and others will correspond more closely to the actual lengths needed. In most cases, the cost of the boom-to-element brackets is less than using a metallic plate and the necessary saddle clamps.

DXE-BEB-1



DXE-BEB-1 with Gorilla Grip® Boom Clamps

The DXE-BEB-1 replaces KLM or equivalent boom-to-element brackets. The bracket is also handy for any application where you need to insulate antenna elements. This patented DX Engineering bracket is made from a much stronger material and features a pair of weather-resistant Gorilla Grip stainless steel clamps. It is five times stronger than the original KLM bracket and lets you use up to 1.25 inch OD element tubing. Gorilla Grip® stainless steel boom clamps ensure your antenna elements won't twist or deform in stiff wind. Use the DXE-ELA-1-2 Element Adapters to use a 1 inch diameter element with the DXE-BEB-1.

DX Engineering offers two hardware kits for the BEB-1. The standard kit is a direct KLM hardware replacement with #10 element fasteners. It includes a pair of Gorilla Grip® stainless steel boom clamps, stainless steel bolts, nuts and washers to attach clamps to the DXE-BEB-1, and stainless steel bolts, nuts and washers to attach elements or adapters to the element brackets. The vibration-resistant nuts have nylon inserts. The HWK-2 heavy-duty kit uses 1/4 inch bolts and hardware, so it is considered an upgrade for KLM brackets.

DXE-BEB-1 Insulated Boom-to-Element Bracket, 3" Boom..... **\$39.99**

DXE-BEB-1HWK KLM Direct Replacement Hardware Kit..... **\$29.99**

DXE-BEB-1HWK-2 Hardware Kit with 1/4" Bolts..... **\$35.99**

DXE-ELA-1-2 Element Adapters, 1.25" to 1", for DXE-BEB-1 **\$46.99**

These brackets are made for 3 inch OD booms only. For 2 inch booms, please use DXE-BEB-2.

DXE-BEB-2 with Gorilla Grip® Boom Clamp

The DXE-BEB-2 is made from an extremely strong, UV-resistant polymer. When bolted to your 2 inch boom using our hardware kit and the included Gorilla Grip boom clamp, it will easily support a split 20M element without a fiberglass centerpiece. It is a budget friendly way to insulate the elements when you're building your next Yagi, LPDA or any boom antenna with a 2" OD boom.

The BEB-2 accepts up to a 7/8 inch element, which is perfect for most 20-6M antennas. Building a large antenna? Use our DXE-BEB-1 Boom-to-Element Bracket.

The DXE-BEB-2 comes in 2 pieces and bolts together with a DXE-BEB-2HWK Stainless Steel Hardware Clamp Kit that also holds it securely to the boom. The hardware kit includes four stainless steel bolts, washers and lock nuts for assembling the bracket. A Gorilla Grip® stainless steel boom clamp is included to attach the element to the bracket. The vibration-resistant nuts have nylon inserts. The DXE-BEB-2HWK Hardware Kit for the DXE-BEB-2 Bracket is sold separately. Larger antennas that experience high winds will require the boom clamp to be pinned to the boom.

DXE-BEB-2 Insulated Boom-to-Element Bracket, 2" Boom..... **\$31.99**

DXE-BEB-2HWK Hardware Kit for DXE-BEB-2 **\$22.99**



DXE-BEB-3

Great for 6 meter Yagis, the DXE-BEB-3 Insulated Boom-to-Element Bracket is a handy, budget-conscious way to mount elements to smaller (1.25 inch to 1.75 inch) booms. The bracket accepts elements up to 3/4 inches. Use the DXE-SEI-1 Split Element Insulator for 3/4 inch OD aluminum tube for the driven element. The insulator allows the element to be securely clamped without crushing the tube.

DXE-BEB-3 Insulated Boom-to-Element Bracket, 1.25", 1.50" or 1.75" Boom **\$7.99**

DXE-SEI-1 Split Element Insulator **\$27.99**



KX40 Vertical Dipole Antenna Support Plate

When John Huggins, KX40 designed his revolutionary AHVD Vertical Dipole, he probably didn't imagine that it would become so popular. The unusual "upside-down T" design delivers such impressive 20-10M coverage, that it's no surprise operators started building them. Let this plate be the foundation of your build. The weather-resistant 0.25" thick polymer plate measures 11.5" x 7.5" and is pre-drilled for easy assembly.

DXE-MMP-KX40 KX40 Vertical Dipole Support Plate **\$27.99**



Orders over \$99 qualify for FREE standard shipping—see pg. 74 for details.

**DX Engineering
Yagi Mechanical®
Antenna Design Software Download**

Developed specifically for antenna-building enthusiasts, DX Engineering Yagi Mechanical Antenna Design Software has been built from the ground up to display a greater range of accurate data while streamlining the design and planning of your beam antenna project.

This completely new version provides greater flexibility in tubing types, simplified data entry, and automated measurement conversions.

In addition, Yagi Mechanical now delivers:

- 3D views
- Real-world mechanical strength calculations
- Real-world wind load calculations
- Material costing
- Links to DX Engineering material

The product listing Overview of the software found at DXEngineering.com contains a web link that provides a free trial version download, or visit YagiMechanical.com to start your free trial and see for yourself the amazing benefits of this significantly upgraded software. Unlock the full version with the purchase of a Yagi Mechanical software license, which is delivered by email typically within two business days.

Enter "Yagi Mechanical" at DXEngineering.com for more details.

DXE-YAGIMECH6.....\$69.99



**FREE trial version
at YagiMechanical.com**
If you are interested in Yagi Mechanical, you can download a trial version FREE! The save, print, and update functions are disabled, but the rest of the program is fully functional, allowing you to try everything before you buy.

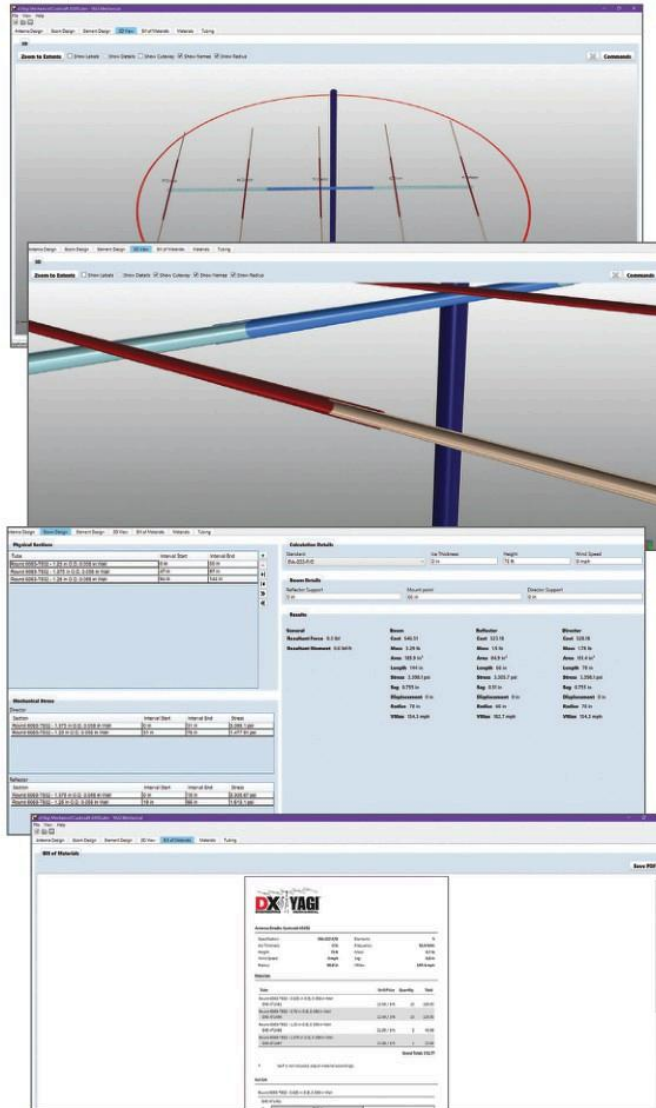

DXE-BEP-4B

Boom-to-Element Plates

Boom-to-element plates are similar in function to insulated boom-to-element brackets, in that they each attach the elements to the boom. The primary advantage of plates over brackets is that it is a simple mechanical arrangement. The main disadvantage is that the plate does not insulate the element from the boom, which means that the element dimensions that you bring from your antenna design program (YO, AO, EZNEC and others) will be incorrect unless you make some length adjustment for the width of the plate and boom.

DXE-BEP-4B

Fabricated from alloy 6061-T6 aluminum, the DXE-BEP-4B is primarily for the smaller 6 meter, 12-10 meter and 17-15 meter beam. This plate can also be used to mount smaller VHF/UHF antennas to a mast using appropriate clamps. The dimensions of the DXE-BEP-4B are 8 inch L x 3.5 inch W x 0.25 inch T. This plate comes pre-drilled for DX Engineering Saddle Clamps.

- For mounting a 2 inch boom use (2) DXE-SAD-200A Clamps
- For mounting a 1.50 inch boom use (2) DXE-SAD-150A Clamps
- For mounting a 1.25 inch grounded element use (2) DXE-SAD-125A Clamps
- For mounting a 1 inch grounded element use (2) DXE-SAD-100 Clamps
- For mounting a 3/4 inch grounded element use (2) DXE-SAD-075 Clamps

DXE-BEP-5B

Fabricated from alloy 6061-T6 aluminum, the DXE-BEP-5B is for the larger 17-15 meter and 20 meter beams. This plate can also be used to mount smaller VHF/UHF antennas to a mast using appropriate clamps. The dimensions of the DXE-BEP-5B are 8 inch L x 3.5 inch W x 0.25 inch T. The plate comes pre-drilled for DX Engineering saddle clamps.



DXE-BEP-5B

- For mounting a 3 inch boom use (2) DXE-SAD-300A Clamps
- For mounting a 2 inch boom use (2) DXE-SAD-200A Clamps
- For mounting a 1.50 inch grounded element use (2) DXE-SAD-150A Clamps
- For mounting a 1.25 inch grounded element use (2) DXE-SAD-125A Clamps
- For mounting a 1 inch grounded element use (2) DXE-SAD-100 Clamps

DXE-BEP-4B Boom-to-Element Plate, 1.5" or 2" booms.....\$22.99
DXE-BEP-5B Boom-to-Element Plate, 2" or 3" booms.....\$23.99

DX ENGINEERING

Pre-Drilled Boom-to-Mast Mounting Plate

DX Engineering BMP-2B Boom-to-Mast Plates keep your Yagi stable and properly secured on the mast. Fabricated from 0.250 in. thick 6061-T651 aluminum, BMP-2B plates come pre-drilled for DX Engineering Saddle Clamps for greater clamping power without crushing the tubing.

DXE-BMP-2B Plate for 1.5", 2", 3" Mast and Boom, Pre-Drilled, 8" W x 10" L\$37.99

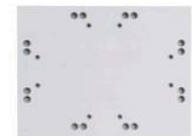

DX ENGINEERING

Multi-Purpose Mounting Plates

These universal mounting plates can be used for many applications. They are available in aluminum or non-conductive black polymer and come blank or pre-drilled to accept our standard DXE-CAVS-1P V-Saddle Clamps, which can accommodate tubing or pipe from 1/2 inch to 1.75 inch OD.

If you are looking for larger sizes, one of our Boom-to-Mast Plates may work. They are available for 1.75 inch, 2 inch and 3 inch OD tubing or pipe. Visit DXEngineering.com for the clamps recommended for use with each specific plate.

DXE-UMP-1 Universal Mounting Plate for 1.75" Saddle Clamp.....\$19.59
DXE-UMP-2 Universal Mounting Plate for 2" Saddle Clamp.....\$18.29
DXE-MMP-P2 Non-Conductive Blank Polymer Plate, 1/4" x 7.5" x 11.5".....\$8.99
DXE-MMP-P3 Non-Conductive Blank Polymer Plate, 1/4" x 7.5" x 16".....\$9.99



DXE-UMP-1

DXE-UMP-2

Need help with your project? Call the tech line at 330-572-3200!



DX Engineering U-Bolt Saddle Clamps

Unlike common hardware store clamps that are sized to fit pipe, our clamps are designed and sized to fit tubing. The U-Bolt Saddle Clamps come with high strength, 18-8 grade stainless steel U-bolts that are long enough to attach tubing or components to thick mounting plates. The U-bolts are available in 1/4 inch, 5/16 inch and 3/8 inch as listed. Note that the 2 inch, 2.5 inch and 3 inch clamps are available with either 5/16 inch or 3/8 inch U-bolts. The U-Bolt Saddle Clamp saddles are cast from high strength 535 aluminum, which has superior anti-corrosion properties. Unlike stamped or machined types, the saddles' rippled surface grips tubing closely for a secure fit. The U-Bolt Saddle Clamps are designed for use with mounting plates, which are available separately. The clamps are sold only as a set with aluminum saddle, stainless steel U-bolts, nuts, flat washers and lock washers. The use of a lubricant and sealant, such as Jet Lube SS-30 (JTL-2555), is highly recommended to achieve proper torque and prevent galling. DX Engineering sells replacement U-bolts with hardware kits.

Size	DXE Part Number	D	L	C	I	T	Hole Size	W	H	t	Price Each
0.50	DXE-SAD-050A	0.50	1.35	0.75	0.87	1/4"-20	0.266 "H"	0.90	0.188	0.63	\$7.99
0.75	DXE-SAD-075A	0.75	1.81	1.00	0.87	1/4"-20	0.266 "H"	1.13	0.188	0.75	\$8.49
1.00	DXE-SAD-100A	1.00	2.06	1.25	0.87	1/4"-20	0.266 "H"	1.50	0.250	1.00	\$8.99
1.25	DXE-SAD-125A	1.25	2.37	1.50	0.87	1/4"-20	0.266 "H"	1.75	0.250	1.00	\$10.49
1.50	DXE-SAD-150A	1.50	2.62	1.75	0.87	1/4"-20	0.266 "H"	2.00	0.250	1.00	\$12.49
1.75	DXE-SAD-175A	1.75	3.00	2.00	1.00	1/4"-20	0.266 "H"	2.31	0.250	1.00	\$11.99
2.00	DXE-SAD-200A	2.00	3.43	2.31	1.12	5/16"-18	0.332 "Q"	2.62	0.375	1.00	\$14.79
2.00	DXE-SAD-200B	2.00	4.00	2.37	1.50	3/8"-16	0.397 "X"	2.62	0.375	1.00	\$16.29
2.50	DXE-SAD-250A	2.50	4.18	2.81	1.25	5/16"-18	0.332 "Q"	3.13	0.375	1.13	\$16.99
2.50	DXE-SAD-250B	2.50	4.75	2.87	1.75	3/8"-16	0.397 "X"	3.13	0.375	1.13	\$24.99
3.00	DXE-SAD-300A	3.00	4.68	3.31	1.25	5/16"-18	0.332 "Q"	3.62	0.375	1.25	\$15.99
3.00	DXE-SAD-300B	3.00	5.25	3.37	1.75	3/8"-16	0.397 "X"	3.62	0.375	1.25	\$16.99
4.00	DXE-SAD-400A	4.05	5.56	4.43	1.50	3/8"-18	0.397 "X"	4.80	0.438	1.50	\$25.99

Suggested Hole Size: 0.266" is letter "H" drill bit, 0.332" is letter "Q" drill bit, and 0.397" is letter "X" drill bit. All U-Bolts are formed from premium 18-8 stainless steel. All Saddles are cast 535 aluminum. All Saddle Clamp Sets are supplied with 18-8 stainless steel nuts and lock washers. Dimensions shown are in inches. Note: These are NOT Automotive Muffler Clamps.

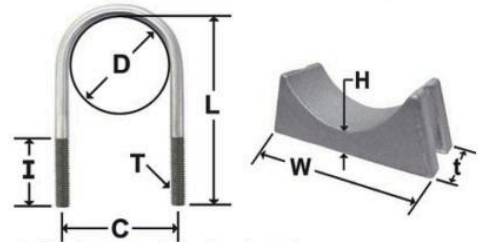
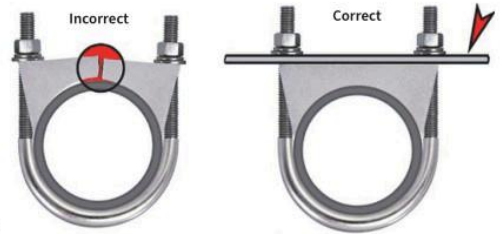

Saddle clamps must be used on a flat surface or customer supplied backing plate. Personal injury and property damage can occur without proper installation. Always use a lubricant such as Never-Seez® or Anti-Seize to prevent the stainless steel hardware from seizing.

DX Engineering Clamps Have Hundreds of Uses!

DX Engineering U-Bolt, V-Bolt, and Band Clamps are very versatile. For example, we've seen the ECLS Studded Band Clamps used to fasten merchandise display signs to upright tubing. Have you used DX Engineering clamps for other, non-antenna projects? We'd love to know about it—drop us a note and send pictures if you have them!

DX Engineering V-Bolt Saddle Clamps

Our V-Bolt Saddle Clamps are sized to fit ranges of tubing. The V-bolts are long enough to attach tubing or components to thick plates and are highly corrosion-resistant. The V-Bolt Saddle Clamps are intended for use with a backing plate or mounting plate to retain the bolt spacing. The saddles' rippled surface will clamp tubing securely to a flat surface.

- Features**
- 18-8 stainless steel V-bolts with nuts, flat washers and lock washers
 - Cast aluminum saddles with rippled surface
 - Available in a number of size ranges

Tubing Recommendations

- DXE-CAVS-1P: fits 1/2 inch to 1 3/4 inch OD tubing, 1/4"-20 bolt
- DXE-CAVS-11P: fits 1/2 inch to 1 3/4 inch OD tubing, 5/16"-18 bolt
- DXE-CAVS-2P: fits 1 inch to 2 inch OD tubing, 5/16"-18 bolt
- DXE-CAVS-3P: fits 2 inch to 3 inch OD tubing, 3/8"-16 bolt

The clamps are sold only as a set with aluminum saddle, stainless steel V-bolts, nuts, flat washers and lock washers. The use of a lubricant and sealant, such as Jet Lube SS-30 (JTL-2555), must be used to achieve proper torque and prevent galling. For high torque load applications where the tubing is subjected to twisting motion, we recommend using our U-Bolt Saddle Clamps.

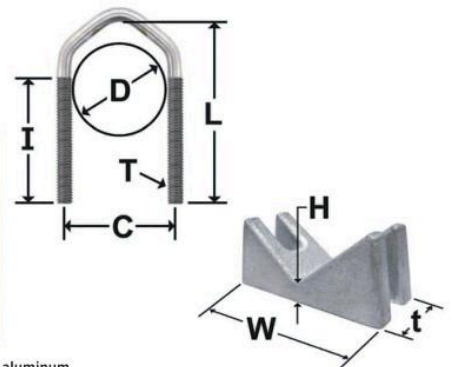

Nominal Size	DXE Part Number	D	L	C	I	T	Hole Size	W	H	t	Price Each
0.50 to 1.75	DXE-CAVS-1P	1.75	3.438	1.968	2.313	1/4"-20	0.266 "H"	2.313	0.250	1	\$15.59
0.50 to 1.75	DXE-CAVS-11P	1.75	3.438	2.063	2.313	5/16"-18	0.332 "Q"	2.313	0.250	1	\$16.49
1 to 2	DXE-CAVS-2P	2.00	3.438	2.313	2.000	5/16"-18	0.332 "Q"	2.835	0.375	1	\$16.99
2 to 3	DXE-CAVS-3P	3.13	4.610	3.500	1.750	3/8"-16	0.397 "X"	4.250	0.500	2	\$23.49

All dimensions are in inches. Note: DXE-CAVS-1/11/2P saddle material is cast 535 aluminum, DXE-CAVS-3P saddle material is cast 319 aluminum. Suggested Hole Size: 0.266" is letter "H" drill bit, 0.332" is letter "Q" drill bit, and 0.397" is letter "X" drill bit. Note: These are NOT Automotive Muffler Clamps.

Orders by 10 pm ET ship the same day. See pg. 74 for details.

DX ENGINEERING

Super Duty Saddle Clamps

Super Duty Saddle Clamps are perfect for building large Yagi or LPDA antennas (where maximum strength is critical). These clamps attach to the tubing and establish a secure mounting point for a flat plate or surface.

Super Duty Saddle Clamps provide maximum grip on booms, masts and element tubing. Unlike stamped or machined-type clamps, Super Duty clamps are cast from rugged aluminum with a special textured surface to grip the tubing. These new clamps mean you can choose an exact size to create an incredibly secure fit that is resistant to torque, wind and weather.

These clamps consist of two cast aluminum saddles and a stainless steel reinforcement plate. Since there are many uses for these clamps, we don't include hardware. Our armor-coated bolt sets are available separately. Typical Super Duty Clamp mounting applications on a 1/4" plate require a minimum length bolt set.

Super Duty Saddle Clamps fit 2.00", 2.50" and 3.00" OD tubing. A thread lubricant and anti-seize compound, like Jet-Lube SS-30, is highly recommended during installation.



Heavy-Duty Saddle Clamps

If a design calls for typical saddle clamps but you want something with more strength, DX Engineering now offers a range of Heavy-Duty Saddle Clamps. They're similar to the Super Duty Saddle Clamps, only they're available for smaller diameter tubing and have the same footprint of a standard saddle clamp. These new Heavy-Duty Saddle Clamps fit 0.75", 1.00", 1.25", 1.50", 1.75" and 2.00" OD tubing. Find each clamp's matching Bolt and Nut set in the table below.

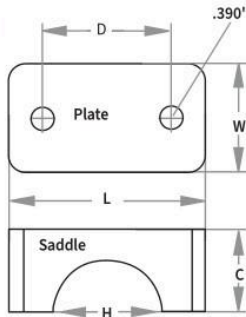

Part Number	Nominal OD	L	W	D	H	C	Price
Super Duty Saddle Clamps							
DXE-SDS-300P	3.000	4.650	2.500	3.400	3.000	2.060	\$61.99
DXE-SDS-250P	2.500	4.150	2.250	2.900	2.500	1.820	\$53.99
DXE-SDS-200P	2.000	3.640	2.000	2.400	2.000	1.570	\$47.99
Heavy-Duty Saddle Clamps							
DXE-HDS-200AP	2.000	3.648	1.000	2.375	2.000	1.565	\$21.29
DXE-HDS-175AP	1.750	3.148	1.000	2.000	1.750	1.315	\$19.99
DXE-HDS-150AP	1.500	2.898	1.000	1.750	1.500	1.190	\$19.29
DXE-HDS-125AP	1.250	2.398	1.000	1.500	1.250	1.065	\$17.79
DXE-HDS-100AP	1.000	2.148	1.000	1.250	1.000	0.815	\$16.79
DXE-HDS-075AP	0.750	1.898	0.750	1.000	0.750	0.690	\$14.49

Saddle Clamp Dimensions in Inches

Bolt and Nuts Sets

These stainless steel bolt sets are specifically tailored to the DX Engineering Super Duty and Heavy-Duty Saddle Clamps. The sets include (2) 8-18 hex head bolts, (2) split washers, (4) flat washers and (2) nuts.

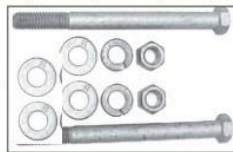

Part Number	Thread Pitch	Length	Thread Length	Price
Stainless Bolt Sets				
DXE-SDSBOLT-6-5S	3/8"-16	6.500	0.750 to 1.000	\$9.99
DXE-SDSBOLT-6S	3/8"-16	6.000	0.750 to 1.000	\$9.49
DXE-SDSBOLT-5-5S	3/8"-16	5.500	0.750 to 1.000	\$9.49
DXE-SDSBOLT-5S	3/8"-16	5.000	0.750 to 1.000	\$9.49
DXE-SDSBOLT-4-5S	3/8"-16	4.500	0.750 to 1.000	\$9.49
DXE-HDSBOLT4-5S	3/8"-16	4.500	0.750 to 1.000	\$9.99
DXE-HDSBOLT3-75S	1/4"-20	3.750	0.750 to 1.000	\$7.99
DXE-HDSBOLT3-5S	1/4"-20	3.500	0.750 to 1.000	\$7.99
DXE-HDSBOLT3-25S	1/4"-20	3.250	0.750 to 1.000	\$6.99
DXE-HDSBOLT2-75S	1/4"-20	2.750	0.750 to 1.000	\$4.99
DXE-HDSBOLT2-5S	1/4"-20	2.500	0.750 to 1.000	\$5.99

Bolt Set Dimensions in Inches

Saddle Clamp Reinforcement Plates

We sell these stainless steel reinforcement plates separately because Hams and professionals have found so many interesting uses for them. From panel repair and shimming to drill guides and chassis covers, we're amazed at the new applications you've discovered for our backing plates.

DX ENGINEERING

Of course, they're also perfect replacements for lost or damaged Super Duty and Heavy-Duty Saddle Clamp Reinforcement Plates. Check the nearby clamps chart for the dimensions that match these reinforcement plates.



Part Number	Matching Saddle Clamp Part Number	For Saddle Clamp Size	Price
Super Duty Saddle Clamp Reinforcement Plates			
DXE-SDSBP-300	For Saddle Clamp DXE-SDS-300P	3.00"	\$19.99
DXE-SDSBP-250	For Saddle Clamp DXE-SDS-250P	2.50"	\$19.99
DXE-SDSBP-200	For Saddle Clamp DXE-SDS-200P	2.00"	\$18.99
Heavy-Duty Saddle Clamp Reinforcement Plates			
DXE-HDSBP-200A	For Saddle Clamp DXE-HDS-200AP	2.000"	\$6.99
DXE-HDSBP-175A	For Saddle Clamp DXE-HDS-175AP	1.750"	\$6.99
DXE-HDSBP-150A	For Saddle Clamp DXE-HDS-150AP	1.500"	\$6.99
DXE-HDSBP-125A	For Saddle Clamp DXE-HDS-125AP	1.250"	\$6.99
DXE-HDSBP-100A	For Saddle Clamp DXE-HDS-100AP	1.000"	\$6.99
DXE-HDSBP-075A	For Saddle Clamp DXE-HDS-075AP	0.750"	\$5.99



Galvanized Economy Saddle Clamps

Though designed for antenna building, these budget-friendly Cycle 24 clamps can be the perfect solution for any mounting, installation or bracketing project. The clamps are made to withstand decades of indoor and outdoor use. Each clamp includes nuts, U-bolt and saddle.



Part Number	For Tubing Size	Thread Pitch	Thread Length	Price
CYT-CL125SG	1.250"	5/16"-18	1.000"	\$8.49
CYT-CL150SG	1.500"	5/16"-18	1.000"	\$8.99
CYT-CL175SG	1.750"	5/16"-18	1.000"	\$9.49
CYT-CL2000516SG	2.000"	5/16"-18	1.000"	\$10.49
CYT-CL2125SG	2.125"	5/16"-18	1.500"	\$10.99
CYT-CL2250SG	2.250"	3/8"-16	1.500"	\$11.49
CYT-CL2500SG	2.500"	3/8"-16	1.500"	\$11.99
CYT-CL3000SG	3.000"	3/8"-16	1.500"	\$12.49
CYT-CL3500SG	3.500"	3/8"-16	1.500"	\$12.99

DX ENGINEERING

Saddle Clamps with Powdercoated Saddles

- Stainless steel flat washers, lock washers, nuts and bolts
- Black powdercoated saddle finish

U-Bolt Style

U-Bolt Part Number	Nominal Size	Thread Bolt Size	Price Each
DXE-PSAD-050A	0.50"	1/4"-20	\$21.99
DXE-PSAD-075A	0.75"	1/4"-20	\$23.99
DXE-PSAD-100A	1.00"	1/4"-20	\$24.99
DXE-PSAD-125A	1.25"	1/4"-20	\$19.49
DXE-PSAD-150A	1.50"	1/4"-20	\$19.99
DXE-PSAD-175A	1.75"	1/4"-20	\$20.99
DXE-PSAD-200A	2.00"	5/16"-18	\$21.99
DXE-PSAD-250A	2.50"	5/16"-18	\$22.49
DXE-PSAD-300A	3.00"	5/16"-18	\$24.99

V-Bolt Style

V-Bolt Part Number	Nominal Size	Thread Bolt Size	Price Each
DXE-PCAVS-1P	0.50"-1.75"	1/4"-20	\$14.99
DXE-PCAVS-2P	1.00"-2.00"	5/16"-18	\$18.99



Need advice? 1-330-572-3200 or DXEngineering@DXEngineering.com



DX Engineering Resin Support Block Clamps

Our Resin Support Block Clamps are ideal for securing mounting brackets or plates to tubing, while also providing electrical insulation. That makes the clamps a good choice for electronic components. The clamps are sturdy and provide a strong, well-insulated mounting that is easy to construct. They are available in many sizes for most any project you might have.

The Resin Support Block is shown with an optional stainless steel reinforcement plate. These plates provide additional stiffness and can also be used as sturdy hole-drilling templates.

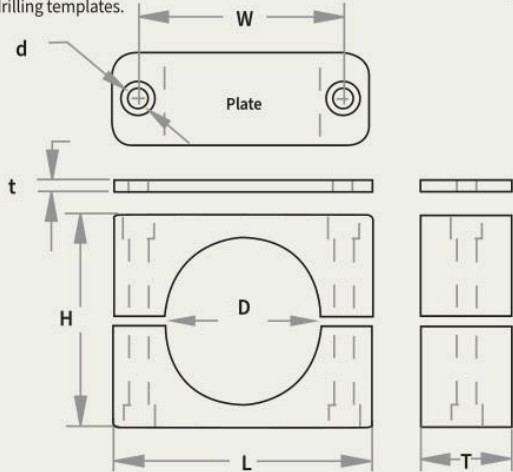

Support Block Dimensions in Inches

Block Part Number	Tube OD	D	H	T	L	W	Reinforcement Plate Required	Price Each
DXE-RSB-I02500	1/4	1/4	1.050	1.185	1.350	0.784	DXE-RSB-DP-1	\$5.49
DXE-RSB-I03125	5/16	5/16	1.050	1.185	1.350	0.784	DXE-RSB-DP-1	\$5.99
DXE-RSB-I03750	3/8	3/8	1.050	1.185	1.350	0.784	DXE-RSB-DP-1	\$5.99
DXE-RSB-I05000	1/2	1/2	1.290	1.192	1.595	1.024	DXE-RSB-DP-2	\$5.99
DXE-RSB-I06250	5/8	5/8	1.290	1.192	1.595	1.024	DXE-RSB-DP-2	\$6.49
DXE-RSB-I03400	3/4	3/4	1.394	1.186	1.910	1.301	DXE-RSB-DP-3	\$6.49
DXE-RSB-I10000	1.000	1.000	1.394	1.186	1.910	1.301	DXE-RSB-DP-3	\$6.99
DXE-RSB-I11250	1.125	1.125	1.665	1.189	2.258	1.575	DXE-RSB-DP-4	\$8.99
DXE-RSB-I12500	1.250	1.250	2.292	1.182	2.760	2.050	DXE-RSB-DP-5	\$9.49
DXE-RSB-I11500	1.500	1.500	2.292	1.182	2.760	2.050	DXE-RSB-DP-5	\$9.99
DXE-RSB-I13400	1.750	1.750	2.674	1.184	3.394	2.600	DXE-RSB-DP-6	\$15.99
DXE-RSB-I20000	2.000	2.000	2.678	1.184	3.394	2.600	DXE-RSB-DP-6	\$16.49
DXE-RSB-I22500	2.250	2.250	2.904	1.184	3.394	2.600	DXE-RSB-DP-6	\$16.99



Reinforcement Plates Dimensions in Inches

Part Number	d	t	W	Each
DXE-RSB-DP-1	0.275	0.119	0.784	\$8.99
DXE-RSB-DP-2	0.275	0.119	1.024	\$9.49
DXE-RSB-DP-3	0.275	0.119	1.301	\$10.99
DXE-RSB-DP-4	0.275	0.119	1.575	\$11.49
DXE-RSB-DP-5	0.275	0.119	2.050	\$11.99
DXE-RSB-DP-6	0.275	0.119	2.600	\$12.49



Cushioned P-Clamps

DX Engineering P-Clamps are ideal for providing strain relief of coaxial cable connections. The rubber insert grips the cable jacket securely without nicking or cutting the jacket, preventing water entry.

- DXE-CPC-250 For RG-8X, RG-6, RG-59 Cable, Pack of 10 **\$17.99**
- DXE-CPC-375 For RG-213, RG-8, RG-11 Cable, Pack of 10 **\$16.99**



Stainless Steel V-Clamps

Ideal for mounting accessories to steel pipe. The V-saddle has serrations that bite into the surface, providing a strong, secure hold. The bolts supplied are long enough to attach tubing to thick plates and have anti-corrosive properties for long life. Some clamps are available with a tab and 1/4" hardware for adding grounding wires. Not recommended for aluminum tubing or pipe.



V-Clamp Part Number	Pipe Size	Ground Lug	Price Each
DXE-SSVC-1P	1/2" to 3/4"	No	\$12.99
DXE-SSVC-1PG	1/2" to 3/4"	Yes	\$11.99
DXE-SSVC-150P	1" to 1.5"	No	\$12.99
DXE-SSVC-150PG	1" to 1.5"	Yes	\$14.29
DXE-SSVC-2P	1" to 2"	No	\$16.49
DXE-SSVC-3P	2.375" to 3"	No	\$19.49

ECLS-Series Band Clamps with Stud

Made from marine grade stainless steel with a 10-24 stud welded to the band. Ideal for mechanical fastening to round or odd-shaped members. Can be used for electrical connections (including grounding) or for mechanical assembly of components, attachment of signs, etc. Threaded hardware included.



Part Number	Size	Price (2)
DXE-ECLS-050	0.500" OD tube	\$16.49
DXE-ECLS-062	0.625" OD tube	\$16.49
DXE-ECLS-075	0.750" OD tube	\$16.49
DXE-ECLS-087	0.875" OD tube	\$17.59
DXE-ECLS-100	1.000" OD tube	\$17.69
DXE-ECLS-125	1.250" OD tube	\$18.99
DXE-ECLS-150	1.500" OD tube	\$18.99
DXE-ECLS-175	1.750" OD tube	\$19.49
DXE-ECLS-200	2.000" OD tube	\$19.49
DXE-ECLS-225	2.250" OD tube	\$19.49
DXE-ECLS-250	2.500" OD tube	\$19.49
DXE-ECLS-275	2.750" OD tube	\$19.99
DXE-ECLS-300	3.000" OD tube	\$19.99
DXE-ECLS-325	3.250" OD tube	\$19.99

Hex Bolt Hardware Sets

Don't compromise your installation integrity with inferior hardware. Designed and tested for Amateur Radio applications, these nut and bolt sets have been precisely made for DX Engineering's own Super Duty Saddle Clamps, Heavy-Duty Saddle Clamps and Resin Support Blocks.

Each "RSBBOLT" set includes a matched pair of nuts and bolts, plus 2 flat washers and 2 split washers. The bolt thread is 1/4"-20 and the bolt hex head is SAE 7/16".



Part Number	Bolt Length	Price
DXE-RSBBOLT1-50	1.5"	\$4.99
DXE-RSBBOLT1-75	1.75"	\$5.99
DXE-RSBBOLT2-00	2.00"	\$5.99
DXE-RSBBOLT2-25	2.25"	\$5.99
DXE-RSBBOLT2-50	2.50"	\$5.99
DXE-RSBBOLT2-75	2.75"	\$5.99
DXE-RSBBOLT3-25	3.25"	\$6.99
DXE-RSBBOLT3-50	3.50"	\$6.99



Hardware Sets for Resin Support Block Clamps

DX Engineering makes these hardware kits precisely for the Resin Support Block Clamps. The sets include a matched pair of stainless steel nuts and bolts, a pair of split washers, and two pair of small/large flat washers. Select your kit based on bolt length below.

- DXE-RSBSBOLT2-50 Resin Support Block Hardware, 2.50" Bolts **\$7.99**
- DXE-RSBSBOLT2-75 Resin Support Block Hardware, 2.75" Bolts **\$7.99**
- DXE-RSBSBOLT3-00 Resin Support Block Hardware, 3.00" Bolts **\$7.99**

Part Number	For Tubing Size (OD)	Per Pack	Price
DXE-ECL-0500-10P	0.375"-0.500"	10	\$19.99
DXE-ECL-0625-10P	0.625"	10	\$19.99
DXE-ECL-0750-10P	0.750"	10	\$19.99
DXE-ECL-0875-10P	0.875"	10	\$21.49
DXE-ECL-1000-10P	1.000"	10	\$21.99
DXE-ECL-1250-10P	1.125"-1.250"	10	\$21.99
DXE-ECL-1500-10P	1.375"-1.500"	10	\$21.99
DXE-ECL-1750-10P	1.625"-1.750"	10	\$23.99
DXE-ECL-2000-10P	1.875"-2.000"	10	\$23.99
DXE-ECL-2250-5P	2.125"-2.250"	5	\$11.29
DXE-ECL-2500-5P	2.375"-2.500"	5	\$11.29
DXE-ECL-2750-5P	2.625"-2.750"	5	\$11.29
DXE-ECL-3000-5P	2.875"-3.000"	5	\$11.29
DXE-ECL-3250-5P	3.25" (max.)	5	\$11.29
Multi-Packs with Pairs of Assorted Sizes			
DXE-ECL-MP1	0.500"-1.500"	14	\$17.29
DXE-ECL-MP2	1.000"-2.250"	12	\$19.99

We're All Elmers Here! Get Expert Support at: Elmer@DXEngineering.com

DX ENGINEERING

Receive Short Element Active Vertical (RSEAV) Antenna

Take advantage of excellent low-noise radio frequency reception from VLA to HF (40 kHz-30 MHz, including 2200M and 630M) with DX Engineering's upgraded, sleek, durable, and stealthy Receive Short Element Active Vertical Antenna, featuring the completely new AVA-3 Active Matching Unit. The AVA-3's state-of-the-art broadband operational amplifier design works as a high-impedance buffer for the connection between a short element and RG6U 75 Ω coax. Benefits include High Third Order Intercept performance of +39dBm for superior strong-signal handling equal to top transceivers, and consistent unit-to-unit gain and phase for greatly improved array performance. The RSEAV-1 also comes with a non-conductive, predrilled mounting plate for easy installation; 8', 6" aluminum tubing three-piece whip; element connection wires with ring and fork terminals; and stainless clamps and hardware. The DXE-RSEAV-1FVI package comes with feed line voltage injector bias tee and 120VAC to 12VDC power source. Antennas also available in sets of 2, 4, and 8. Enter "RSEAV-1" at DXEngineering.com for more details.

DXE-RSEAV-1



DXE-RSEAV-1	RSEAV Antenna	\$249.99
DXE-RSEAV-1FVI	RSEAV Antenna with Bias Tee	\$349.98
DXE-RSE-R	RSEAV Antenna Tubing and Mounting Plate Kit	\$104.99
DXE-RSE-A	RSEAV Replacement Tubing Element Kit	\$69.99
DXE-RSEAV-2	RSEAV Antennas, Set of 2	\$499.98
DXE-RSEAV-4	RSEAV Antennas, Set of 4	\$999.96
DXE-RSEAV-8	RSEAV Antennas, Set of 8	\$1,999.92

AVA-3 Active Matching Unit

The heart of DX Engineering's RSEAV antennas, the AVA-3 features internal jumper selection of relative gain settings, with the factory default of -6dB, as well as 0dB and +6dB settings, to match the ambient noise conditions for the antenna location and to adjust for the size of the antenna element being used. The unit can be used for VLF through HF reception with short metal or wire elements that measure from less than 6' up to 24'. It can also be employed by using the Direct DC F connector for installations where the use of the AVA-3 internal bias tee is undesirable.



DXE-AVA-3	Active Matching Unit	\$139.99
-----------	----------------------------	----------

Receive 8 Circle

V3 Complete Array System

Version 3 of DX Engineering's Receive 8 Circle Array System is designed to be used with eight identical, symmetrically-spaced vertical elements—active or passive—to provide switching for an eight-direction receiving antenna system. (Passive elements will generally provide you with a monoband receiving system).



DXE-RCA8C-SYS-2P

The Receive 8 Circle system uses time-delay phasing (rather than conventional narrow-band, frequency dependent phasing) to provide eight 45 degree-spaced directional patterns. The time-delay phasing is directivity-optimized to produce wider and deeper rear nulls and a narrower main lobe. The result is greatly reduced noise and undesirable signals for a superior front-to-rear ratio (F/R). Better control of phase and currents provides a cleaner pattern than found on vertical antenna transmit arrays.

The system also offers greater reliability in receiving applications. The RC8 controller uses sealed relays—sized for receiving applications—with oxidation-resistant silver contacts. Most transmitting circle array switches use large open-frame relays with exposed brass contacts, which can lead to contamination, oxidation and poor conductivity.

The DXE-R8C-SYS-V3 Receive 8 Circle Complete Array System contains:

- DXE-RCA8C-1 Receive 8 Circle Array Controller
- Eight DXE-RSEAV-1 Receive Short Element Active Vertical Antennas with updated DXE-AVA-3 matching units and aluminum elements
- DXE-CC-8AMOD special 8-position Receive 8 Circle Deluxe Control Console
- Stainless Steel V-clamps and assembly hardware
- Two DXE-RG6UFQ 1,000 ft. rolls of RG6U 75 Ω flooded quad shield coaxial cable
- DXE-CPT-659 Coax Cable Prep Tool
- DXE-SNS-CT1 RG6 Type-F Compression Connector Tool
- DXE-EX6XL-25 25 Type-F Universal Compression Connectors

DXE-R8C-SYS-V3	Receive 8 Circle Complete Array System	\$3,447.34
----------------	--	------------

The DXE-RCA8C-SYS-2P Controller and Switch Package includes:

- DXE-RCA8C-1 Receive 8 Circle Array Controller
- DXE-CC-8AMOD Receive 8 Circle Deluxe Control Console
- DXE-SSVC-2P Stainless Steel V-Clamp for mounting the RCA8C-1 to a 1-2" OD post

DXE-RCA8C-SYS-2P	Receive 8 Circle Controller and Switch Package	\$815.98
------------------	--	----------

Control Cable

COM-CW4	Cable, 4-Conductor	per foot \$0.85
COM-CW4-1000	Cable, 4-Conductor, 1,00' Spool	\$579.99

Complete Electronically Steered Receiving System

- More than 5 S-units of front-to-back on optimized systems
- Works best on 160M, 80M and 40M
- Like having a rotatable Beverage antenna
- Fits in YOUR yard!
- Easily installed

Want to know what people are saying about this system?

Visit: www.eham.net/reviews/detail/5336

DX ENGINEERING



DXE-RFS-SYS-2P



DXE-R8C-SYS-V3 Complete Package

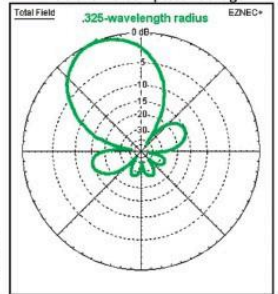

Receive Four-Square V3 Array System

Version 3 of DX Engineering's Receive Four-Square Array System delivers dramatically improved reception of weak, distant MW and SW signals with excellent rejection of extraneous signals and noise. This four-direction switchable phased array covers multiple HF Amateur bands, such as 160, 80 and 40 meters, by using time delay phasing of four physically short active receive vertical elements. The resulting directional receiving pattern has deep back and side nulls that are superior to Beverage antennas and other receive arrays, making the system a great choice for HF amateur operating, SWL, or AM DXing.

- Excellent directivity over a very wide frequency range, and in a small space, with four DXE-RSEAV-1 Receive Short Element Active Vertical (RSEAV) Antennas, featuring updated DXE-AVA-3 Active Matching Units
- Switchable in four 90 degree spaced directions
- Reduced susceptibility to high angle signals compared to EWE, Flag, Pennant or K9AY arrays
- Operates from 100 kHz to 30 MHz
- Each complete package includes four RSEAV antennas,* with AVA-3 matching units and aluminum elements, RFS-3 four-square array controller, EC-4 control console, 1,000 feet of 75 Ω RG6U flooded cable, connectors, hardware and tools
- Active antennas now ship in 38" packages for low-cost shipping.

DXE-R4S-SYS-V3	Receive Four-Square System Complete Package	\$1,903.39
DXE-RFS-SYS-2P	Four-Square Controller and Switch Package	\$527.98

System components also available individually.

DXE-EC-4	Four-Square Switch Console, 4-Position BCD Output	\$171.99
DXE-CPT-659	Coaxial Cable Stripping Tool	\$36.99
DXE-SNS-CT1	RG6 Type-F Compression Connector Tool	\$53.99
DXE-EX6XL-25	25 Type-F Universal Compression Connectors	\$27.99

Enter "DXE-R4S" at DXEngineering.com for more details.

DX ENGINEERING

Receive Antenna Matching Transformer

Enjoy the best possible receive performance with this useful device. The transformer matches your receive antenna 75 Ω output impedance to the nominal 50 Ω input impedance of most receivers. The transformer may be used in almost any receiving application that requires a 75 Ω Type F connection to a 50 Ω BNC connector. The unit boasts low insertion loss (< 0.3 dB) and excellent frequency coverage (100 kHz-30 MHz). This feedline transformer is for use only on receive antenna systems, does not pass DC, and cannot be connected to a transmitting RF power source.



New!

DXE-RX75-50-XFMR	Receive Antenna Matching Transformer	\$55.99
------------------	--	---------

Easy International Ordering. DXEngineering.com has a simple shipping calculator that can give you an exact price total before you check out.

No matter what country you're in, we can get you the parts and gear you need to get on the air. Same-day shipping means you'll get it quickly, too.

Visit DXEngineering.com for the latest limited-time offers and special savings!



DX ENGINEERING

NCC-2 Receive Antenna Phasing System

The NCC-2 allows you to phase one receive antenna with a transmit antenna or two receive antennas with each other. That means you can use the NCC-2's phasing and balance controls to electronically "rotate" an antenna pattern, steering the pattern null(s) to reduce interference, so you'll enjoy improved reception and signal-to-noise ratio. Even if you have space constraints on your property, you can enjoy the benefits of antenna phasing and noise-nulling.

The NCC-2 features superior phasing and balancing capabilities over other receiving devices. A built-in Receive-Transmit Interface relay system allows direct transceiver connection.

The NCC-2 has four advantages over typical phased antenna systems. First, the array can be electronically steered or directed using physically stationary antennas. Second, the user adjusts the direction and wave angle of either a null or peak. Third, the response can change from a signal null to a perfect signal peak with the flip of a single switch. Lastly, front panel adjustments compensate for less-than-ideal antenna installations, making a directional array possible in most situations.

Another important feature of the NCC-2 Receive Antenna Phasing System is expandability. It includes internal slots for installing optional DX Engineering Plug-in Modules, like the RPA Receive Preamp, Receiver Guard 5000HD, 75 to 50 ohm Impedance Transformer, and Transmit-Receive Interrupter.

NCC-2 features and quick specs:

- Nulls out noise from power lines, lamp dimmers, motors, and other electronics
- Phasing voltage controlled, allowing for precise resetting of phase
- Built-in, 2-channel voltage controlled attenuator system
- Low noise, high dynamic range amplifiers
- Separate control for reversing phase
- Keying PTT line out for amplifiers and accessories
- Separate channel receive antenna feedline bias tee settings
- Rear panel SO-239, F and BNC connectors
- Frequency range: 300 kHz to 30 MHz
- Third order output intercept (TOI): +32 dBm each input/+38 dBm combined
- Gain flatness: +/- 1 dB over complete phase rotation gain
- Attenuation adjustable from 0 dB to -40 dB
- Available phase rotation: >360 degrees between 300 kHz and 30 MHz
- Input power 13.8 nominal @ 2A maximum
- Antenna feedline power: 13.8 at @ 300mA maximum

DXE-NCC-2	Receive Antenna Variable Phasing System.....	\$949.99
DXE-KWD-RTR	Special Kenwood/NCC Keying Cable	\$52.99

NCC-2 and Filter Combos

Get more out of your NCC-2 with band-specific directional noise and signal nulling performance. By reducing or excluding frequency specific signals that normally cause interference, these filters help lower the noise floor of the desired pass-band to dramatically improve reception. Filters are available for the 160-10 meter bands, and come in low pass, band pass and high pass frequency ranges. For full details, enter "DX Filter Sets" at DXEngineering.com. Combos come with two plug-in adapter boards and two filters.

Part Number	Frequency Range	Coverage	Price
DXE-NCC2FL-BP160	Band Pass	160M	\$162.96
DXE-NCC2FL-BP40	Band Pass	40M	\$238.96
DXE-NCC2FL-BP80	Band Pass	80M	\$162.96
DXE-NCC2FL-HP160	High Pass	160M	\$142.96
DXE-NCC2FL-HP40	High Pass	40M	\$130.96
DXE-NCC2FL-HP80	High Pass	80M	\$130.96
DXE-NCC2FL-LP160	Low Pass	160M	\$134.96
DXE-NCC2FL-LP40	Low Pass	40M	\$134.96
DXE-NCC2FL-LP80	Low Pass	80M	\$130.96

DXE-NCC2FL-LP80



DX ENGINEERING

Connector Terminating Loads

These useful devices can be used on receive equipment, splitters and feedlines for operational and testing purposes. Available in packs of five with 50 Ω BNC connectors or 75 Ω F-Type connectors.

DXE-TL50-BNC-5P	Connector Terminating Loads, 50 Ω BNC, 5 Pack.....	\$22.99
DXE-TL75-F-5P	Connector Terminating Loads, 75 Ω F-Type, 5 Pack.....	\$15.29



We stock many more items than we can show. See them all at DXEngineering.com!

Clifton Laboratories Products by DX Engineering

Here is welcome news for radio experimenters and electronics enthusiasts. With the acquisition of Clifton Laboratories in 2016, DX Engineering is offering updated versions of a few select devices that were created by the talented engineer, Jack Smith, K8ZOA (SK).



DXE-Z10046B-PM



DXE-DMC-2

Preamp and Filter Plug-in Modules

DX Engineering has adapted the Clifton Laboratories Z10046A High-Output Preamp (23 dB gain). Virtually identical to its predecessor, this super-versatile preamp can plug directly into the DXE-NCC-2 and DXE-RTR-2 units. Use it as a separate in-line receive-only preamplifier by installing this module into the DXE-DMC-2 Dual Module Chassis.

The DXE-Z10020-PM Receive AM Reject Filter Plug-in Module is also for use with the DXE-NCC-2 and DXE-RTR-2 or as a standalone filter installed into the DXE-DMC-2 Dual Module Chassis. It can drastically reduce RF signals in the 530 to 1700 kHz MW range up to 80 dB while passing frequencies below and above this range with minimal attenuation.

DXE-Z10046B-PM	Clifton Labs Z10046B 23 dB Preamp Plug-In Module.....	\$109.99
DXE-DMC-2	Dual Module Chassis for DX Engineering Plug-In Modules.....	\$195.99
DXE-Z10020-PM	Clifton Labs AM Band Filter Module.....	\$163.99



DXE-Z10000U-KIT

Buffer Amplifier Kits

Add a spectrum/waterfall display to an older receiver or transceiver. This high input/low output impedance Buffer Amplifier can tap the IF signal from inside your radio and feed it to your SDR receiver with panadapter display. Two complete and tested Clifton Labs Buffer Amplifier Kits are offered, Universal and K2. The updated DX Engineering Z10000C PC Boards feature all the benefits of the reliable original Z10000B. Our kits include required coaxial cables, special connectors and hardware for easier installation. Instructional web links are found at DXEngineering.com, keyword "Clifton Labs."

DXE-Z10000U-KIT	Clifton Labs Z10000C Universal Buffer Amplifier Kit...	\$51.99
DXE-Z10000K2-KIT	Clifton Labs Z10000C Elecraft K2 Buffer Amplifier Kit	\$61.99

DX ENGINEERING

RPA-2 Modular Receive Preamplifiers

We've completely redesigned some of our most popular products to make them easier to use. This newest version of our RPA series preamplifier boasts the same industry leading performance as the previous version. The key improvement here is its internal expansion slot that allows you to add one of our new plug-in modules, like the Receiver Guard or the 75 to 50 Ω impedance transformer. This new unit also features BNC and F connectors to ensure a reliable, 50 Ω connection.

These low noise preamps are optimized for the 300 kHz to 35 MHz range, letting you hear the weakest signals without artificially raising the noise. The use of robust components allow these preamplifiers to withstand high signal levels while providing superior dynamic range and third-order intercept performance that equals or exceeds most transceiver front-ends. RPA-2 Modular Receive Preamplifiers include our exclusive, advanced push-pull design that eliminates harmonic distortion. Their high quiescent current increases their ability to handle strong signals without distortion or overload.

To ensure you get the highest performance and reliability out of your RPA-2, we highly recommend using a well filtered, regulated 13.8 Vdc power supply.

RPA-2 Series Specifications

- Gain: 16 dB, +/- 1.5 dB over entire frequency range
- Output Third Order Intercept: 43 dBm
- Noise Figure: 3.5 dB
- One dB Compression Point: +26 dBm (400 mW output)
- Dynamic Range, IM3: 110 dB or greater (500 kHz BW)

The RPA-2-PM is a Plug-In Module version of the same unit, allowing it to be installed in one of the expansion slots of our NCC-2 and RTR-2 units.

DXE-RPA-2	Modular Receiver Preamplifier.....	\$269.99
DXE-RPA-2-PM	Receive Preamplifier Plug-In Module.....	\$79.99



DXE-RPA-2



DXE-RPA-2-PM

DX ENGINEERING

75 to 50 Ω Impedance Plug-In Module

The DX Engineering RPA-2, RTR-2 and NCC-2 are inherently 50 Ω circuits. This handy PCB card plugs into your RPA-2, RTR-2 or NCC-2 and allows them to accept a 75 Ω receive antenna feedline.

DXE-IT-PM	75 to 50 Ω Impedance Plug-In Module.....	\$35.99
-----------	--	----------------



DX ENGINEERING

Transmit Receive Interrupter Plug-In Module

The DXE-TRI-PM provides protection from station transmit energy picked up by a receive antenna connected to the DXE-NCC-2 Channel B Receive Antenna Input active front end. This optional PCB card plugs into your RPA-2, RTR-2 or NCC-2 and allows them to accept a 75 Ω receive antenna feedline. Note: Adding a second DXE-TRI-PM to the top slot of the NCC-2 Channel A rear panel is recommended for further protection. **Enter "TRI-PM" at DXEngineering.com for more details.**

DXE-TRI-PM	Transmit Receive Interrupter Module.....	\$44.99
------------	--	----------------



New!

Dual Module Chassis

DX Engineering has made it simpler and more convenient to protect your receiver and enhance its performance. Each multi-purpose DMC-2 receive device box serves as the connector and power interface box for two DX Engineering plug-in modules and receive filters. It's perfect for creating a wide pass filter, protecting a receiver with a filter and a limiter, or adding a preamplifier that has filtering or limiter protection. A DXE-RXFL-1 Receive Filter Adapter Board is required to install optional RXFL receive filters. The unit can accommodate one or two filters to create the filter type and input signal band pass frequency coverage and limitations that serve your needs. For full details and a list of compatible modules and RXFL receive filters, **enter "DX Dual Module" at DXEngineering.com.**

DXE-DMC-2	Dual Module Chassis.....	\$195.99
-----------	--------------------------	-----------------



DX ENGINEERING

RTR-2 Modular Receive-Transmit Interface

The new RTR-2 is the safest solution for adding a separate receive antenna to a transceiver that doesn't have a dedicated receive antenna port. This fast receive-transmit relay switches between antennas without worry. It has a unique failsafe keying input plus a new amplifier key out. Sharing main antenna with SDR receiver/display using optional external splitter is easy, or use it as a T/R switch for boat anchors. More new RTR-2 features include Bias-Tee for active vertical or magnetic loop antennas plus this unit operates on 13.8 Vdc; three internal slots for new plug-ins; impedance transformer (for 75 Ω feedlines), Receiver Guard and Receive Preamplifier modules, front panel switch for preamp in/out, 50 Ω, BNCs and SO-239s, 200W, 1.8 to 54 MHz.

Owners of Kenwood radios have previously been unable to use either the RTR-1 or RTR-2 because of interface problems. We've remedied that issue with our new KWD-RTR keying cable. Check your Kenwood's compatibility at DXEngineering.com.

DXE-RTR-2	Modular Receive-Transmit Interface.....	\$375.99
DXE-KWD-RTR	Special Kenwood/RTR Keying Cable.....	\$52.99
DXE-RG5000HD-PM	Receiver Guard 5000 HD Plug-In Module.....	\$80.99
DXE-IT-PM	75 to 50 Ohm Impedance Transformer Plug-In Module.....	\$35.99
DXE-RPA-2-PM	Receive Preamplifier Plug-In Module.....	\$79.99



DX ENGINEERING

Receiver Guard RG5000HD

Protect your sensitive receiver front-end against high levels of RF from nearby transmit signals. A DX Engineering Receiver Guard is the best limiter device to choose if your receive antenna input could be subjected to high levels of RF. They are a must for contesting stations and are useful for all stations, for Field Day, SWLs and when a neighbor or passing mobile generates potentially damaging RF peaks.

Extensively tested and proven in real-world stations, the RG5000HD works for all radios and offers the ultimate performance required by the upper tier of transceivers tested to have the best narrow-spaced third-order dynamic range or published RMDR (Reciprocal Mixing Dynamic Range). These transceivers include Elecraft K3 series, FlexRadio 6700, 5000A and 3000, Icom IC-7851, Kenwood TS-990S and 590S(G), TenTec Orion series, Yaesu FTDX-5000 series, and other radios with similar performance.

At the heart of the Receiver Guard is a highly effective electronic RF limiter covering 500 kHz to 150 MHz with an insertion loss under 0.15 dB at 50 MHz and under 0.3 dB to 150 MHz. Its multi-stage design includes a gas discharge tube for maximum pulse energy protection. The RG5000HD is a passive electronic limiter, not a filter, so competitive contesting stations still use separate band filters. The Receiver Guard's limiters can reject 10 watts of catastrophic receive antenna feedline RF while passing a signal of about 87 dB over S-9, which is only 25 mw! That level is well under the point of front-end damage.

When there are high levels of RF on your receive antennas, DX Engineering's RG5000HD generates far less harmonic noise than other limiters on the market, which allows your station to continue to operate safely and competitively. At normal HF signal levels the Receiver Guard operates continuously with no effect on the performance of your station while providing the best possible protection for your radio.

The RG5000HD-PM variant is a Plug-In Module version of the Receiver Guard HD, allowing it to be installed in one of the expansion slots of our NCC-2 and RTR-2 units.

DXE-RG5000HD	Receiver Guard RG5000HD.....	\$99.99
DXE-RG5000HD-PM	Receiver Guard RG5000HD Plug-In Module.....	\$80.99



DX ENGINEERING

2-Port Splitter-Combiners

Before you use a standard parallel connection to combine antenna systems, check out the advantages of DX Engineering's new 2-Port Splitter-Combiners. Available for 50- or 75-ohm systems, these units can be used to split one RF signal to feed two receivers or the receiver inputs of one transceiver and a separate receiver. They can also be used to combine two receiving antennas in phase, such as beverage antennas, to form a phased receive array. The splitter-combiners match the entire system to the feedline impedance, have extremely high bandwidth, limit signal loss to 3 dB per port, and provide high isolation between ports, preventing either antenna or device from interfering with the other during normal operation.

DXE-SC-50	50 Ω, BNC female connectors.....	\$100.99
DXE-SC-75	75 Ω, F female connectors.....	\$107.99



DXEngineering.com is loaded with detailed photos, specs, videos, and more!



Hi-Z Now Part of DX Engineering Family of Brands

In 2022, DX Engineering acquired Hi-Z Antennas, including their HF directional receiving array products, ensuring that the company's most popular offerings will continue to be available to hams worldwide. DX Engineering is working toward full production and advanced testing of Hi-Z devices. The current research and development process will significantly advance the durability and efficiency of the high-performance Hi-Z Antennas Triangular, Four-Square, and Eight-Circle Receive Array Systems. Look for announcements from DX Engineering and at OnAllBands.com for product availability in the months to come. Hi-Z Antennas joins other highly regarded amateur radio brands which DX Engineering has acquired over the years, including Butternut Antenna, Clifton Laboratories, Comtek, Top Ten Devices, and TransWorld Antennas.

DX Engineering Adds KD9SV Products to Its Family of Brands



With the acquisition of KD9SV Products, DX Engineering is committed to ensuring the performance-enhancing, breakthrough devices for low-band reception and station operation—designed by Gary Nichols, KD9SV—will continue to be available. DX Engineering will be reintroducing selected KD9SV-inspired products in the months ahead so that Gary's innovative work will live on. Visit DXEngineering.com for news and availability on specialized items, including the Solid State Keying Relay, Reversible Beverage-On-Ground systems, 160/80M preamps and more.

Receive Feedline Current Choke

The Receive Feedline Current Choke (RFCC) is the most effective solution to common-mode noise or unwanted signal ingress in receiving systems available. It provides thousands of ohms isolation between the input and output coaxial shield connections while passing desired signals, including DC or low frequency AC control signals. The RFCC has extremely high isolation impedance, which effectively blocks common-mode noise or unwanted signals, even in the presence of very poor grounding. The RFCC is effective from 300 kHz to 30 MHz. It comes with standard type F female connectors, although it can be used in any 50 to 75 Ω receiving system.



DXE-RFCC-1 Receive Feedline Current Choke, 50/75 Ω , 0.3-30 MHz..... **\$129.99**

Time Variable Sequence Unit

Protect your active antennas, transmit/receive relays and other equipment with this sequence unit. You get full control of the timing between your radio and your amplifier. This microprocessor-controlled unit provides 0-30 milliseconds of delay, in 2 millisecond increments to as many as 5 outputs that are initiated by your CW keying or external PTT footswitch or hand switch, not by the radio.



The device has a built-in side tone generator for CW. Which means you can listen to what you're keying while it's being held in the bucket brigade delay for transmit after the programmed delay. This side tone is adjustable from 300 to 000 Hz in 50 Hz steps. The unit supports full break-in CW and requires 13.8 Vdc. It also allows you to use DX Engineering's Active Receive Antennas in close proximity to your transmit antennas.

DXE-TVSU-1B Time Variable Sequence Unit..... **\$319.99**

Single Direction Beverage Feed System

The DXE-BFS-1 is a single-wire Beverage Feed System. This W8JI design is immune to strong signal overload and core saturation common in multi-transmitter contesting environments, and is used by winning contest stations and low-band DXers. The unit uses an isolated-winding, matching transformer system to significantly increase the signal-to-noise ratio in Beverage and other high impedance antennas.

The DXE-BFS-1 works with antenna impedances from 400-500 Ω . Included with the DXE-BFS-1 is a 470 Ω , 2 watt non-inductive resistor that withstands nearby lightning strikes significantly better than hard-to-find carbon composition resistors.

Feedline impedance on the DXE-BFS-1 is designed for 75 Ω , although it will work with 50 Ω coax. The DXE-BFS-1 uses an industry standard CATV F connector. DX Engineering sells quality 75 Ω coax and F connectors for outdoor installations.

Benefits

- 100 kHz to 30 MHz operating range
- Spark gaps minimize damage from lightning
- Wing nut terminals eliminate soldering
- Metal housings used for superior shielding and improved life
- Flange-mount holes for easy mounting
- Ground isolated secondary essential for building Beverage arrays



DXE-BFS-1 Beverage Feed System, with One Resistor..... **\$115.99**
 DXE-ECM-R470-2 470 Ω , 2 Watt Resistor, Lightning Damage-Resistant, Pack of 10 **\$31.99**



Reversible Beverage System

The DXE-RBSA-1P allows two Beverage antennas receiving in opposing directions to share the same space. With the DXE-RBSA-1P, you can build a 2-wire reversible Beverage antenna system with superior signal-to-noise ratio, most useful at 160, 80 and 40M bands. The W8JI design consists of a Feedpoint System and Reflection Transformer. You can operate and even confirm the F/R ratio of this antenna at any time from the operating position.

This system is immune to strong signal overload and core saturation common in multi-transmitter contesting environments, and is used by winning contest stations and low-band DXers.

The DXE-RBSA-1P has two antenna ports. The standard configuration of the DXE-RBSA-1P has one port terminated (termination included) so both antennas share a common feedline. Applying 10 to 18 Vdc to the feedline switches between the antenna, and the direction of reception. For simultaneous reception from opposing directions, each of the two feedlines connect to a separate receiver.

While the DXE-RBSA-1P is optimized to use 450 Ω ladder line for the antenna element, the system will work with any 300-600 Ω 2-wire line. 450 Ω ladder line is available from DX Engineering, sold separately. DX Engineering also sells quality 75 Ω coax and F connectors for outdoor installations.

Benefits

- Broad operating range, 0.2 to 30 MHz
- Fully isolated grounds used to prevent common-mode noise and unwanted signals
- 75 Ω design enables the use of high quality, low cost cable with F connectors
- Metal housings used for superior shielding and improved life

DXE-RBSA-1P Reversible Beverage Feed System..... **\$309.98**
 DXE-TB-5P Tilt Base for DXE-RBSA-1P **\$24.49**



2-Port Receiving Antenna Switch

Select one of two output ports (generally connected to different receiving antennas) from one feedline using the DXE-RLS-2. Install the DXE-RLS-2 with two DXE-RBSA-1A Reversible Beverage Antenna Systems and select four directions using a single main feedline. Install one or more DXE-RLS-2 switches to expand larger Beverage arrays and share the feedline back to the operating position.

Applying a nominal 12 Vac or DC control voltage through the feedline activates transfer to port 2. Use DX Engineering's DXE-FVC-1 Voltage Coupler to supply the control voltage through the feedline.

Benefits

- Metal housings used for superior shielding and improved life
- High-quality components
- Reliable CATV F connectors standard
- Broad 0.3 to 30 MHz operating range with 75 Ω systems
- Jumper-selectable—control voltage pass-through to the selected port

DXE-RLS-2 Receiving Antenna Switch **\$115.99**



Feedpoint Voltage Coupler

- Inject control voltages onto feedline
- Injects +/- 12 Vdc or 12 Vac
- For use with DXE-RBSA-1P Reversible Beverage Systems
- Required 120VAC to 12VAC supply is included

DXE-FVC-1 Feedpoint Voltage Coupler **\$185.99**



Replacement Phasing Controllers for Hi-Z V2 Receive Array Systems



If you are looking for a replacement phasing controller for your Hi-Z V2 Receive Array System, DX Engineering has you covered. These phasing controllers are the primary component that is included in the previously available Hi-Z Triangular, Four-Square, and Eight-Circle V2 packages. They properly combine all signals from shortened, ground-mounted vertical elements (sold separately). Enter "Hi-Z Phasing Controller" at DXEngineering.com

HIZ-PC-3A 3 Element V2 Array Phasing Controller **\$199.00**
 HIZ-DL-3A 75 Ω Adjustable Delay Line for V2 Triangular Array..... **\$21.00**
 HIZ-PC-4A 4 Element V2 Array Phasing Controller **\$439.00**
 HIZ-PC-8PRO 8 Element V2 Array Phasing Controller **\$649.00**



Prices are subject to change without notice.

DX ENGINEERING

Vertical Antenna

The DXE-AL24 Vertical Antenna includes ground-mounting plate, clamps, and wires to connect a receive-only element amplifier, such as the upgraded replacement DXE-AVA-3, or the legacy Hi-Z or DXE-AVA-2 models. This 24-foot telescoping aluminum tubing antenna is made to withstand the elements.

DXE-AL24 Vertical Antenna for DXE and Hi-Z Receive Systems.....**\$415.99**

Suggested Parts

Sometimes Ham Radio gear requires special accessories like hookup cables and brackets to complete an installation. Visit DXEngineering.com and check out the "Suggested Parts" tab on certain products to see what you'll need to get up and running.

UM Unified Microsystems

Beverage Antenna Transformer

The transformer's output is a perfect match for low-loss 75 Ω RG-6 CATV coaxial cable, which keeps your overall receive antenna system cost down. Plus, it's fully enclosed in a weathertight, plastic housing, making it a great option if you deploy your Beverage antenna year-round. The BT-75 also has a built-in gas discharge tube for protection against lightning strikes. Integrated flanges make it easy to mount, too.

UMS-BT-75 Beverage Antenna Transformer....**\$37.95**



UM Unified Microsystems

BevFlex-4X Reversible Receive Antenna Systems

Take advantage of Unified Microsystems' versatile BevFlex-4X Reversible Receive Antenna System to enjoy the exceptional performance of a two-direction, low-noise, low-band receiving antenna that's perfect for Hams facing property size limitations.

The BevFlex-4X is the updated and improved version of W8GNM's antenna design that uses low-cost, low-loss RG-6 coaxial cable for the elements and the feedline for a Reversible Elevated Beverage, Reversible Beverage-on-Ground (BOG), EWE, Flag or VE3DO loop antenna.

The BevFlex-4X allows Hams to place and connect the feedpoint unit anywhere along the length of an Elevated Beverage or BOG antenna, rather than only at one end or the other. This flexibility allows an operator to position the feed at a more optimal location, such as closer to the shack. Operators can install two BevFlex-4X systems at right angles to cover all four quadrants of the compass. The antenna enables operators to instantly switch to the reverse direction regardless of the configuration. The system includes a feed unit, two terminator units, and a control switch unit. The new BevFlex-4X-Q combines two sets of terminator and feed units with the RAS-4 remote antenna switch to let you hear better in all four quadrants.

- UMS-BEVFLEX-4X BevFlex-4X Dual-Direction Reversible Receive Antenna System**\$349.99**
- UMS-BEVFLEX-4X-Q BevFlex-4X 4-Direction Reversible Receive Antenna System**\$649.95**
- UMS-RAS-4 Receive Antenna Switch for up to 4 Antennas.....**\$124.95**



UM Unified Microsystems

RXT Terminating Resistors

Unified Microsystems continues to build top-quality high-performance parts for competitive Hams. Its RXT series terminating resistors have been designed to work with the most popular types of low band receive antennas. The 2-watt, high-surge-tolerant resistors feature low inductance, a gas discharge tube for added electrical protection, a NEMA-rated case for handling the toughest conditions, stainless steel hardware and internally coated electronics.

- UMS-RXT-1000 Terminating Resistor, 1,000 Ohms.....**\$21.99**
- UMS-RXT-470 Terminating Resistor, 470 Ohms.....**\$21.99**
- UMS-RXT-270 Terminating Resistor, 270 Ohms.....**\$21.99**



DX ENGINEERING

Active Magnetic Loop MF/HF Receiving Antenna

The well-known RF-PRO-1B® is now manufactured and sold exclusively by DX Engineering. This original Pixel loop design incorporates a high performance Norton preamplifier designed by Clifton Laboratories' engineer Jack Smith, K8ZOA with excellent broadband reception from 50 kHz to 30 MHz. Installation is easy, because it's only 38 inches in diameter. When rotated, this antenna provides deep nulls for effective reduction of directional noise and interfering signals. Ideal for Amateurs, SWLs and AM DXers, this loop also offers up to 30 dB rejection of electrostatic field noise. This receive only antenna cannot be connected to a transmitter RF output.

- Rejects power line noise
- Rugged construction, easily mounts to a pole or flat vertical surface
- No manual tuning necessary
- Low profile design works at ground level
- Modular construction for easy installation and maintenance

DXE-RF-PRO-1B Active Magnetic Loop Antenna **\$799.99**



DX ENGINEERING

NOISELOOP Portable Receive Flag Antenna Kit

Based on a design by Don Kirk, WD8DSB (see QST article, March 2021), this kit lets you build a receive-only portable directional HF loop antenna measuring only 48" by 24" plus 36" mast handle. Used for tracking down local signals while walking or stationary with your portable HF receiver (e.g., HT, SW, IC-705 or similar rigs), the antenna features a cardioid pattern at the horizon with a deep null of up to 30 dB rejection. It makes an excellent tool for locating noise sources from 1.8 through 30 MHz and for low-noise, general coverage reception from the AM broadcast band through 30 MHz. Kit includes fiberglass tubing for the frame and handle, mounting plate, separate PC boards for the bifilar wound transformer and load resistor, antenna wire, coaxial cable with male BNC, and stainless steel hardware. Simple hand tools and a soldering iron are required for assembly, typically 1 to 2 hours. An optional Preamplifier-Attenuator Unit, DXE-NL-PRE-ATT-1, may be attached to the loop mast handle for enhanced operations. Weighing less than 9 oz., the fully assembled unit includes easy-to-slide attenuation switches for -10 dB or -20 dB and -30 dB and an AM Broadcast Band Rejection Filter. The device provides a nominal 30 dB gain across the frequency range from 100 kHz through 30 MHz; runs on a 9V battery (not included).

- DXE-NOISELOOP Portable Receive Flag Antenna Kit**\$135.99**
- DXE-NL-PRE-ATT-1 NOISELOOP Portable Preamplifier-Attenuator**\$175.99**

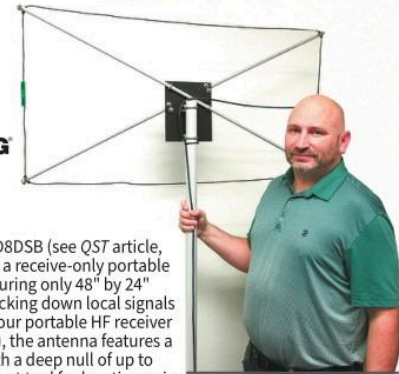

WIMO

QRM Eliminator

Get ready to make contacts you thought were impossible thanks to WiMo's new adjustable phasing network for canceling out QRM. The team at WiMo understand the headaches Amateur operators experience due to noise interference from local electronic sources, such as computers, TVs and power supplies. The company's easy-to-tune QRM Eliminator is a handy device that gets rid of local interference up to an S9 level. The inline unit is inserted into the feedline from the trx to the antenna without any additional radio modifications required. The box includes a built-in PTT control which enables the QRM Eliminator to stay connected during transmit. The QRM Eliminator uniquely allows you to adjust phase angle as well as amplification to cancel out unwanted signals before they reach the receiver front-end. An additional auxiliary receiving antenna, such as a 2m antenna or even a couple feet of wire, is required.

WMO-26000 QRM Eliminator, Adjustable Phasing Network **\$209.99**



Our catalog is only the beginning! See thousands of products at DXEngineering.com

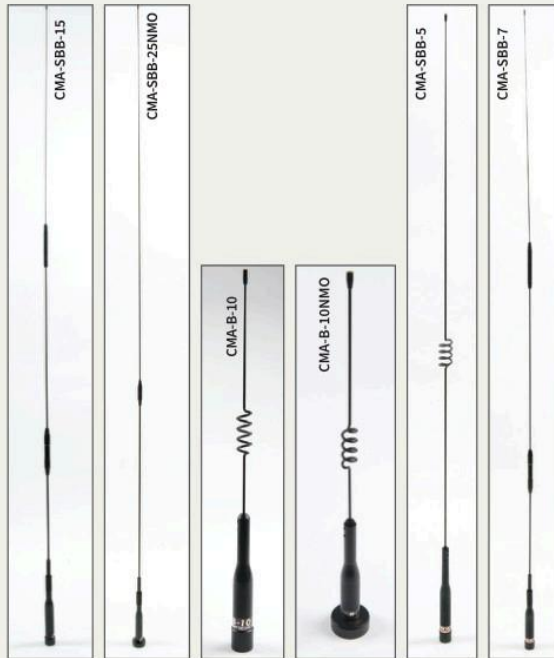

Mobile Antennas

Comet lets you take your show on the road with a vast selection of effective, reliable and durable mobile antennas. There are options for every common band, plus dual-band and tri-band antennas too. Comet also gives you several different antenna styles to ensure the installation in your vehicle stays clean and unobtrusive.

In addition to use in your vehicle, these mobile antennas are also great for Field Day or EMCOMM. Their rugged durability makes them portable, even in less-than-ideal conditions. Take a look at the chart; it is easy to find one that's perfect for your needs.

You can get all the specs at DXEngineering.com.

Tri-Band

Part Number	Description	Height	Band(s)	Gain	Price
CMA-SBB-15	Tri-Band Mobile Antenna, Black, Fold-Over, UHF Base	61"	6 Meter 2 Meter 70cm	2.4 dBi 4.5 dBi 7.2 dBi	\$89.99
CMA-SBB-224	Tri-Band Mobile Antenna, Black, Fold-Over, UHF Base	36"	2 Meter 1.25 Meter 70cm	2.1 dBi 3.5 dBi 6 dBi	\$79.99
CMA-SBB-224NMO	Tri-Band Mobile Antenna, Black, Fold-Over, NMO Base	36"	2 Meter 1.25 Meter 70cm	2.1 dBi 3.5 dBi 6 dBi	\$79.99



Multi-Band Mobile Antennas

Combine incredible frequency coverage in a rugged package, and you get these versatile antennas from Comet. You can make SWR adjustments independently and achieve SWR levels lower than a monoband antenna.

A fold-over hinge is included with both models, handy for low overhangs, and they have a PL-259 connector. Available in quad-band and six-band models, these antennas are a great option if you want extended mobile coverage without turning your vehicle's roof into an antenna farm.

CMA-UHV-4	10M/6M/2M/70cm Quad-Band Mobile Antenna, 54" High	\$119.99
CMA-UHV-6	40M/15M/10M/6M/2M/70cm Six-Band Mobile Antenna, 76" High	\$169.99

HFJ-350MTOYBX Portable Telescopic Antenna

Here's something convenient and powerful that you'll want to stash in your truck or Go-Kit. The three-division, lightweight HF portable HFJ-350MTOYBX makes it easy and quick to tune the 160 through 6M bands by manually changing the antenna's plug tap connection and whip length. This 10-band antenna includes a 10-section telescopic element, 160M extension coil, and base coil with M-P connector. It extends to 75" and collapses to 14" for easy transport. Power rating: 75W SSB PEP on 1.8 and 3.5 MHz; 100W SSB PEP on 7.0-50 MHz. Comet recommends use on your UHF mount or adapter with a counterpoise wire and tuner for best results.

CMA-HFJ350MTOYBX	10-Band Portable Antenna	\$137.99
CMA-CCB-HFJ	Cloth Roll-Up Pouch, Toy Box HFJ-350M	\$29.99

Dual-Band

Part Number	Description	Height	Band(s)	Gain	Price
CMA-B-10	Dual-Band Mobile Antenna Black, UHF Mount	12"	2 Meter 70cm	— 2.1 dBi	\$42.99
CMA-B-10NMO	Dual-Band Mobile Antenna Black, NMO Mount	12"	2 Meter 70cm	— 2.1 dBi	\$42.99
CMA-SBB-1NMO	Dual-Band Mobile Antenna Black, NMO Mount	16"	2 Meter 70cm	1.5 dBi 2.1 dBi	\$45.99
CMA-SBB-2	Dual-Band Mobile Antenna Black, UHF Mount	18"	2 Meter 70cm	2.1 dBi 3.8 dBi	\$42.99
CMA-SBB-2NMO	Dual-Band Mobile Antenna Black, NMO Mount	18"	2 Meter 70cm	2.1 dBi 3.8 dBi	\$42.99
CMA-SS-460SBNMO	Dual-Band Mobile Antenna Black, NMO Spring Mount	18"	2 Meter 70cm	2.1 dBi 3.8 dBi	\$43.99
CMA-MA-721	Dual-Band Mobile Antenna, Mag Mount, 16.5' Coax w/ PL-259 and SMA Connectors	19.5"	2 Meter 70cm	1.7 dBi 4.1 dBi	\$44.99
CMA-SS-680SB	Dual-Band Mobile Antenna Black, UHF Spring Mount	27"	2 Meter 70cm	2.1 dBi 4.1 dBi	\$46.99
CMA-SS-680SBNMO	Dual-Band Mobile Antenna Black, NMO Spring Mount	27"	2 Meter 70cm	2.1 dBi 4.1 dBi	\$46.99
CMA-SBB-5	Dual-Band Mobile Antenna Black, Fold-Over, UHF Mount	38"	2 Meter 70cm	3 dBi 5.5 dBi	\$58.99
CMA-SBB-5NMO	Dual-Band Mobile Antenna Black, Fold-Over, NMO Mount	38"	2 Meter 70cm	3 dBi 5.5 dBi	\$58.99
CMA-CSB-750A	Dual-Band Mobile Antenna Fold-Over, UHF Mount	42"	2 Meter 70cm	3.6 dBi 6.1 dBi	\$75.99
CMA-SBB-7	Dual-Band Mobile Antenna, Black, Fold-Over, UHF Mount	55"	2 Meter 70cm	4.5 dBi 7.2 dBi	\$79.99
CMA-SBB-7NMO	Dual-Band Mobile Antenna Black, Fold-Over, NMO Mount	55"	2 Meter 70cm	4.5 dBi 7.2 dBi	\$79.99
CMA-CSB-790A	Dual-Band Mobile Antenna Fold-Over, UHF Mount	62"	2 Meter 70cm	5.1 dBi 7.7 dBi	\$109.99



CA-2x4SR Mobile Vertical Antennas

These antennas are built to assist search and rescue volunteers who need voice communications on the Ham, land mobile and FRS frequency ranges. With these 40" antennas you get remarkable coverage, with 3.8 dBi gain on 2M and 6.2 dBi gain on 70cm. Plus, you'll be able to transmit and receive in both bands. Made for the field, these are the ideal mobile antennas for EMCOMM.

CMA-CA-2X4SR	2M/70cm Broadband Mobile Antenna, UHF Base	\$69.99
CMA-CA-2X4SRNMO	2M/70cm Broadband Mobile Antenna, NMO Base	\$69.99
CMA-CA-SPR	Optional Spring Section for 2X4SR Antennas	\$21.99



For new hams, check out our Getting Started HT, Mobile, and Base Radio Packages!



CMA-SD2ANTNCG



CMA-DG2ANTPF

No-Hole Fender Brackets

Mount your mobile antenna without damaging your truck or SUV's paint. The brackets use the existing fender bolts, so there are no holes to drill and no set-screws that could scratch your vehicle's finish. The brackets have a 3/4" hole that works with most NMO and UHF mount cable assemblies. Don't see your vehicle listed? Visit DXEngineering.com to see more brackets.

Part Number	Vehicle Applications	Price
Chevrolet/GMC		
CMA-SUANTPF	2000-02 Silverado 2000-06 Suburban/Sierra	\$26.99
CMA-AVANTPF	2003-06 Silverado 2004-06 Avalanche	\$26.99
CMA-COANTNCG	2012-23 Canyon, Colorado	\$26.99
CMA-CVANTPF	2007-13 Silverado, Sierra 1500, Avalanche; 2007-14 Suburban, Tahoe, Yukon, Sierra 2500/3500	\$26.99
CMA-SU2ANTNCG	2015-20 Subn./Tahoe/Yukon	\$26.99
CMA-CVANTPF	2007-13 Silverado, Avalanche, Sierra 1500; 2007-14 Suburban, Tahoe, Sierra 2500/3500	\$26.99
CMA-CV2ANTNCG	2014-19 Silverado; 2014+ Sierra 1500; 2015-19 Sierra 2500/3500	\$26.99
CMA-CV2ANTNCG-R	2014-19 Silverado/Sierra, Passenger's Side	\$26.99
CMA-CV3ANTNCG	2020+ Silverado/Sierra Driver's Side	\$26.99
CMA-CV3ANTNCG-R	2020+ Silverado/Sierra Passenger's Side	\$26.99
Dodge		
CMA-DGANTPF	2002-08 Ram 1500-3500	\$26.99
CMA-DG2ANTPF	2009-18 Ram 1500; 2010-18 Ram 2500/3500/4500/5500	\$26.99
CMA-DG3ANTNCG	2019-23 Ram 1500-3500	\$26.99
Ford		
CMA-FOANTPF	2005-08 F-150	\$26.99
CMA-FO2ANTPF	2009-14 F-150; 2009-17 Exp.	\$26.99
CMA-FO3ANTNCG	2015-20 F-150; 2018-21 Exp.	\$26.99
CMA-FO4ANTNCG	2021+ F-150 Driver's Side	\$26.99
CMA-FO4ANTNCG-R	2021+ F-150 Pass. Side	\$26.99
CMA-SDANTPF	2005-10 F-Series Super Duty	\$26.99
CMA-SD2ANTNCG	2011-16 F-Series Super Duty	\$26.99
CMA-DGANTPF	2011-14 Explorer	\$26.99
CMA-EXANTNCG	2015-19 Explorer	\$26.99
CMA-FO3ANTNCG-R	2015-20 F-150; 2017-22 Super Duty; 2018-21 Expedition Pass. Side	\$26.99

COMET™

Mobile Antenna Mounts

You've invested a lot of time and money in your mobile antenna, now make sure it stays put with a genuine Comet Antenna Mount.

Comet gives you several mounting options and many require no drilling, so there are no unsightly holes to cover up. Whatever your antenna size may be, there's a quality mount available for it. Some mounts come in kit form, complete with cable assemblies and connectors. Others allow you the freedom to choose how to connect your antenna. Drive safe and operate freely, knowing your antenna is secured right where it's supposed to be, by choosing a Comet Antenna Mount.



CMA-CK-3M



CMA-CM-5M



CMA-CP-5M



CMA-RS-520

CMA-RS-730

Part Number	Description	Base Type	Includes	Price
CMA-3D4M	Standard Mobile Lip-Mount Cable Assembly	UHF	Mount, 13' of Coax, O-Ring, PL-259 Cable Connectors	\$29.99
CMA-3D4N	Standard Mobile Lip-Mount Cable Assembly	Type N	Mount, 13' of Coax, O-Ring, PL-259 Cable Connectors	\$32.99
CMA-3D5M	Standard Mobile Lip-Mount Cable Assembly	UHF	Mount, 16.5' of Coax, O-Ring, PL-259 Cable Connectors	\$32.99
CMA-CK-3-3-8-24	Deluxe Mobile Mount Cable Assembly	3/8"-24 Receptacle	Mount, 16' of Coax, O-Ring, PL-259 Cable Connectors	\$42.99
CMA-CK-3M	Deluxe Mobile Mount Cable Assembly	UHF	Mount, 16.75' of Coax, O-Ring, PL-259 Cable Connectors	\$37.99
CMA-CK-3M5	Deluxe Mobile Mount Cable Assembly	UHF	Mount, 16' of Coax, O-Ring, PL-259 Cable Connectors	\$42.99
CMA-CK-3NMO	Deluxe Mobile Mount Cable Assembly	NMO	Mount, 9.75' of Coax, O-Ring, NMO/PL-259 Cable Connectors	\$42.99
CMA-CK-5N	Deluxe Mobile Mount Cable Assembly (for RS-730)	Type N	Mount, 16' of Coax, O-Ring, Type N Cable Connectors	\$49.99
CMA-CM-5M	Mobile Antenna Magnet Mount	UHF	Magnet Mount, Base, 13' of Coax, PL-259 Connectors, Rubber Boot	\$32.99
CMA-CM-5NMO	Mobile Antenna Magnet Mount	NMO	Magnet Mount, Base, 16.9' of Coax, NMO/PL-259 Connectors, Rubber Boot	\$32.99
CMA-CP-5M	Mobile Antenna Adjustable Lip Mount	UHF	Mount, 16' of Coax, PL-259 Cable Connectors	\$74.99
CMA-CP-5NMO	Mobile Antenna Adjustable Lip Mount	NMO	Mount, 16' of Coax, NMO and PL-259 Cable Connectors	\$74.99
CMA-CR-5M	Standard Cable Assembly	UHF	Mount, 16' of Coax, PL-259 Cable Connectors	\$24.99
CMA-CST-30	Antenna Connector Mounting Bracket Kit	Holes for SMA/BNC	For IC-705 and FT-818ND, BNC Male to UHF Adapter Cable Included	\$36.99
CMA-HD-5-3-8-24	Mobile Antenna Adjustable Lip Mount	3/8"-24 Receptacle	Mount, 16' of Coax, Rubber Pad, Set Screws, PL-259 Connector	\$85.99
CMA-HD-5M	Mobile Antenna Adjustable Lip Mount	UHF	RS-840 Bracket, CK-3M5 Cable Assembly	\$84.99
CMA-LD-5M	Mobile Antenna Small Adjustable Lip Mount	UHF	Mount, 16' of Coax, Rain Cap, PL-259 Cable Connectors	\$64.99
CMA-MG-4N	Mobile Antenna Magnet Mount (2.5 GHz)	Type N	Magnet Mount, 13' of Coax, Rain Cap, Type N Cable Connector	\$54.99
CMA-RS-660U	Mobile Antenna Adjustable Roof Rack Mount	—	Mount (UHF Connector Required)	\$39.99
CMA-RS-520	Mobile Antenna Light-Duty Adjustable Lip Mount	—	Mount (UHF Connector Required)	\$29.99
CMA-RS-720	Mobile Antenna Med.-Duty Adjustable Lip Mount	—	Mount (UHF Connector Required)	\$29.99
CMA-RS-720NMO	Mobile Antenna Med.-Duty Adjustable Lip Mount	—	Mount (NMO Connector Required)	\$29.99
CMA-RS-730	Mobile Antenna Heavy-Duty Adjustable Lip Mount	—	Mount (Connector Required)	\$32.99
CMA-RS-840	Mobile Antenna Heavy-Duty Adjustable Lip Mount	—	Mount (Connector Required)	\$41.99

DXEngineering.com is loaded with detailed photos, specs, videos, and more!

DIAMOND ANTENNA

Mobile HF Monoband Antennas

Made for miles of reliable operation, these antennas provide low SWR and no-compromise performance. They feature fold-over hinges and SO-239 mounts. The stainless steel construction means they'll handle the rigors of mobile use, while the 2-piece design makes them easy to store.

Part Number	Band	(PEP)	Height	Price
DMN-HF80CL	80M	120 W	87.5"	\$72.99
DMN-HF40CL	40M	200 W	86.6"	\$72.99
DMN-HF20CL	20M	200 W	86.6"	\$72.99
DMN-HF6CL	6M	250 W	86.6"	\$72.99

DMN-HF10CL

DIAMOND ANTENNA

Mobile Screwdriver Antenna

Imagine: One antenna, ALL HF bands—plus 6 meters. Available with a UHF mount or a 3/8"-24 stud mount, these antennas are your answer for a comprehensive mobile HF setup. They run off your vehicle's 12 Vdc system and allow you to move from band-to-band with the flick of a switch. The SD330 antenna also provides excellent SWR and can handle 200 watts PEP.

These antennas stand over 73 inches tall and weigh 2.5 pounds, so make sure your vehicle can handle the size. The kits include the antenna, motor, switch and wiring harness.

DMN-SD330 Mobile Screwdriver Antenna, HF Mount **\$399.99**

73 inches tall when fully extended.

DIAMOND ANTENNA

Mobile Antennas

Diamond offers you an extensive line of mobile antennas, so you can easily find one suited for your exact demands. These antennas are the ideal fusion of price, quality and versatility. Whether your priority is based on gain, height, power or aesthetics, there's a Diamond Antenna that's perfect for you. Check out the charts shown here.



Part Number	Description	Height	Band(s)	Gain	Price
Monoband					
DMN-HF6CL	Fold-Over, UHF Mount	86.6"	6m	2.15 dBi	\$72.99
DMN-M285S	Trim-to-Tune, UHF Mount	50"	2m	3.4 dBi	\$31.99
DMN-M285SNMO	Trim-to-Tune, NMO Mount	50"	2m	3.4 dBi	\$33.99
DMN-NR22L	Fold-Over, UHF Mount	96.8"	2m	6.5 dBi	\$68.99
Dual-Band					
DMN-AZ504SP	Spring Base, UHF Mount	15.5"	2m/70cm	2.1 dBi	\$41.99
DMN-NR72BNMO	Mobile Antenna, NMO Mount	13.8"	2m/70cm	2.1 dBi	\$40.99
DMN-MR77	Mini Mag-Mount, Coax, UHF Male	20"	2m/70cm	2.1 dBi 3.4 dBi	\$37.99
DMN-MR77SJ	Mini Mag-Mount, Coax, SMA Female	20"	2m/70cm	2.1 dBi 3.4 dBi	\$37.99
DMN-MR77SMA	Mini Mag-Mount, Coax, SMA Male	20"	2m/70cm	2.1 dBi 3.4 dBi	\$37.99
DMN-NR73BNMO	Radial-less, NMO Mount	33.5"	2m/70cm	2.1 dBi 5.3 dBi	\$56.99
DMN-NR770HNMO	Chrome Radial-less, NMO Mount	38.2"	2m/70cm	3 dBi 5.5 dBi	\$55.99
DMN-NR770HBNMO	Black Radial-less, NMO Mount	38.2"	2m/70cm	3 dBi 5.5 dBi	\$55.99
DMN-NR770HA	Chrome Radial-less, UHF Mount	40.2"	2m/70cm	3 dBi 5.5 dBi	\$53.99
DMN-NR770HB	Black Radial-less, UHF Mount	40.2"	2m/70cm	3 dBi 5.5 dBi	\$53.99
DMN-NR7900A	Fold-Over, UHF Mount	57"	2m/70cm	3.7 dBi 6.4 dBi	\$99.95
DMN-SG7900ANMO	Fold-Over, NMO Mount	62"	2m/70cm	5 dBi 7.6 dBi	\$119.99
Tri-Band					
DMN-CR320A	Fold-Over, UHF Mount	37.4"	2m 1.25m 70cm	2.1 dBi 3.8 dBi 5.5 dBi	\$79.99
DMN-CR320BNMO	Fold-Over, NMO Mount	37.4"	2m 1.25m 70cm	2.1 dBi 3.8 dBi 5.5 dBi	\$79.99
Quad-Band					
DMN-CR8900A	for Yaesu FT-8900/8900R, SO-239, Not Recommended for Magnet Mounts	50"	10m/6m/ 2m/70cm	2.1 dB/ 5.5 dB	\$114.99

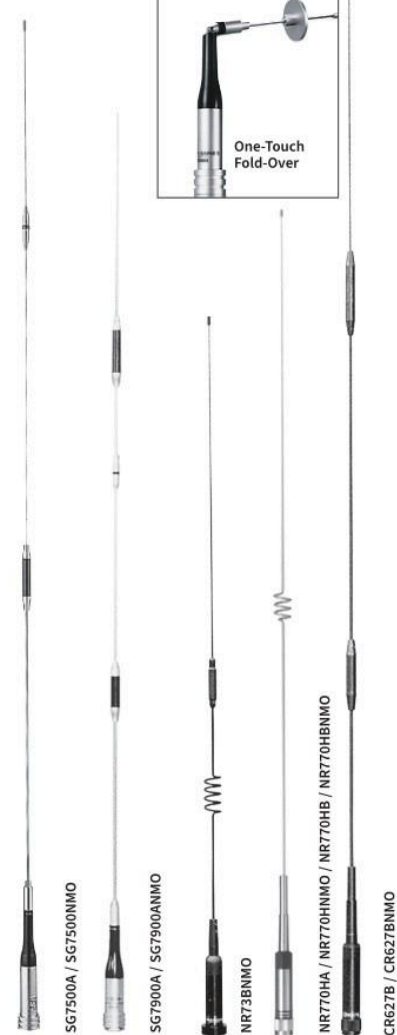

Supergainer Antennas

If you want an effective mobile wideband antenna that offers great performance without a lot of tuning and adjustment headaches, then Diamond's Supergainer series is perfect. These wideband antennas feature 24K gold plated connector pins for excellent continuity, and the fold-over design is invaluable if you face low overhead obstructions like garages or parking decks.

DMN-SG7000A	2M/70cm Wideband Antenna, UHF, 18.5"	\$72.99
DMN-SG7500A	2M/70cm Wideband Antenna, Radial-less, UHF, 40.6"	\$72.99
DMN-SG7500NMO	2M/70cm Wideband Antenna, Radial-less, NMO, 41"	\$77.99
DMN-SG7900A	2M/70cm Wideband Antenna, Radial-less, UHF, 62.2"	\$114.99
DMN-AZ507RSP	2M/70cm SlimGainer, Radial-less, UHF, 27.5"	\$47.99

MOONRAKER

MKR-13-299

Dual-Band Tactical Handheld and VHF Scanner Antennas

The Dual-Band Tactical Handheld's innovative folding design, stealthy height (18.9"), and light weight (1.23 oz.) make it easy for you to carry your HT in a pocket or backback without removing the antenna. Even better, this SMA female omnidirectional antenna (144-430MHz, 3.5 dBi gain, SWR less than or equal to 1.5) has a power rating of 20W PEP and delivers the kind of performance and coverage range you'd expect from a longer antenna. For upgraded VHF scanner operation, Moonraker's Super Gainer Airband Antenna has a 118-137 MHz range, measures 15.5", handles up to 10W, and delivers 2.15 dBi gain.

MKR-13-202	2M/70cm Handheld Antenna	\$27.99
MKR-13-299	VHF Scanner Antenna	\$26.99

Orders over \$99 qualify for FREE standard shipping—see pg. 74 for details.

DIAMOND ANTENNA

Magnet Mounts

A magnet mount that stays put! These deluxe mounts feature powerful magnets housed in a heavy four to six inch diameter base. The deluxe model can even hold antennas up to 50 inches tall. If you need a magnet mount that you can set-and-forget, Diamond gives you plenty of choices.

- DMN-DPK4NM-N Magnet Mount, 13' Coax, Type N, for 45" Antenna Max.....\$54.99
- DMN-K702M Magnet Mount, Deluxe Low-Profile, PL-259, for 50" Antenna Max\$58.99
- DMN-SPM35 Magnet Mount, 13' Coax, PL-259, for 45" Antenna Max.....\$49.99

DMN-K702M



CRM Mirror and Luggage Rack Mount

It's a beautifully simple right-right angle bracket with a U-bolt that creates a proven, secure attachment point for mirrors, racks or anything made from tubing up to 1 1/16" OD. The mount is stainless steel to withstand years of outdoor abuse. It has a 5/8" hole for your UHF connector.

- DMN-CRM CRM Mirror and Luggage Rack Mount.....\$16.99



K412 Series Trunk and Hatchback Mounts

These mounts are similar to Diamond's K400 series, but are tailored for medium-duty applications. K412 Series Trunk and Hatchback mounts are perfect for medium-sized HF antennas under 45 inches.

- DMN-K412C K412 Mount, 6.6' Coax, UHF Base/Mini UHF Cable Connector.....\$67.99
- DMN-K412CNMO K412 Mount, 6.6' Coax, NMO Base/Mini UHF Cable Connector.....\$67.99
- DMN-K412S K412 Mount, 13.6' Coax, UHF Base/SMA Male Cable Connector.....\$71.99
- DMN-K412SNMO K412 Mount, 13.6' Coax, NMO Base/SMA Male Cable Connector.....\$71.99

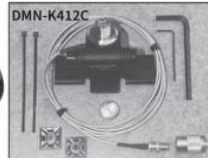

K400 Series Trunk and Hatchback Mounts

These K400 Series deluxe heavy-duty mounts are ideal for large VHF/UHF and medium-sized HF antennas—including many popular screwdriver antennas. The strong mounts are adjustable on two axis. Install them vertically or horizontally without drilling any holes in your vehicle's body.

- K400 Mounts**
- DMN-K400 Trunk/Hatchback Mount Only\$41.99
 - DMN-K400-3-8C 6.5' Coax, 3/8"-24 Base/Mini UHF Cable Connector.....\$73.99
 - DMN-K400C 6.5' Coax, UHF Base/Mini UHF Cable Connector.....\$73.99
 - DMN-K400CNMO 6.5' Coax, NMO Base/Mini UHF Cable Connector.....\$73.99
 - DMN-K400S 13.5' Coax, UHF Base/SMA Male Cable Connector.....\$79.99
 - DMN-K400SNMO 13.5' Coax, NMO Base/SMA Male Cable Connector.....\$79.99
 - DMN-K400-3-8C2 13.5' Coax, 3/8"-24 Base/Mini UHF Cable Connector.....\$79.99



UHF Mobile Antenna Mount Weather Cap

Keep your exposed UHF mobile antenna mount free of corrosion so it's always ready when you need to remount the antenna. Keep one in the car and screw it on whenever the antenna is removed from the UHF mount to drive into a garage or go through a car wash.

- DMN-31005 Weather Cap.....\$3.99



Mobile Mount Adapter

If you're going to run a big mast or antenna on your mobile rig, chances are that it's going to have a stud mount. Make your installation go smoothly with this handy adapter that takes your SO-239 antenna mount and converts it to a 3/8"-24 stud mount. It includes male/female adapters for the stud, too.

- DMN-D38-24 Mobile Mount Adapter.....\$19.99



HRKS Adhesive Backed Antenna Mount

If you don't want to drill a hole or put a mag-mount on your car, Diamond offers an adhesive backed antenna mount that securely adheres to glass, steel, fiberglass—virtually any smooth, flat surface. When it's time to remove the mount, just use some fishing line to "saw" it off without a trace. This two-piece adjustable mount has an SO-239 antenna base, 13.6 feet of coax ending in an SMA male connector and an SMA female to PL-259 adapter.

- DMN-HRKS Adhesive Backed Antenna Mount.....\$71.99



DIAMOND ANTENNA



K9000 Series Mobile Motor Drive Mounts

Raise and lower your dual-band mobile antenna with the touch of a button. A 12V cigarette lighter plug-powered manual switch allows you to tilt your antenna up and down—perfect for garages or low overpasses. A 20 foot long DC power cord is included to complete your setup. These mounts are compatible with antennas that are under 45 inches tall, and don't require a ground. They are designed to mount securely to your luggage rack/tubing or trunk/hatch lip. Requires hole mount cable assembly shown below.

- DMN-K9000LRM Mobile Drive Mount for Small, Tubular Luggage Rack.....\$119.99
- DMN-K9000LRMO Mobile Drive Mount for Large, Oversize Luggage Rack.....\$119.99
- DMN-K9000TM Mobile Drive Mount for Trunk Lid or Hatchback.....\$119.99



DMN-K9000LRM



DMN-K9000LRMO

DIAMOND ANTENNA



DMN-C101



DMN-C213SMA



DMN-C110

Hole Mount Cable Assemblies

Whether used as stand-alone antenna mounts or cable extensions, these assemblies will help you create a clean installation. They feature slim 1/8 inch diameter PTFE coax and mini UHF connectors, allowing you to easily thread these mounts through holes, between panels and around corners.

- DMN-C101 6.5' Coax, UHF Base/Mini UHF Cable Connector.....\$39.99
- DMN-C10138CKIT 6.5' Coax, 3/8"-24 Base/Mini UHF Cable Connector.....\$44.99
- DMN-C101NMO 6.5' Coax, NMO/Mini UHF Cable Connector.....\$39.99
- DMN-C211 6.5' Coax, UHF/Mini UHF Cable Connector, C110 Ext. Cable\$49.99
- DMN-C213SMA 13.6' Coax, UHF/SMA Male Cable Connector\$45.99
- DMN-C213SNMO 13.6' Coax, NMO/SMA Male Cable Connector\$45.95
- DMN-C110 10' Extension Cable, Mini UHF Male/Female Connectors.....\$19.99

K515, K540 and K550 Series Luggage Rack Mounts

Ideal for your vehicle's luggage rack, these mounts clamp securely for a stable connection. The K540 Series can even clamp to your long mirror arm or any 1/2 to 7/8 inch tubing. Every model includes a handy fold-down feature, so you can lower your antenna for garages and parking decks. All three series are well suited for lightweight and medium-sized antennas. Diamond's K515 Series is recommended for antennas under 50 inches tall, and the K550 Series is great for antennas under 45 inches.

- K515 Mount**
- DMN-K515S Luggage Mount w/UHF Mount and 13' Cable/PL-259\$71.99
 - DMN-K515SNMO Luggage Mount w/NMO Mount and 13' Cable/PL-259\$71.99
- K540 Mount**
- DMN-K540 Luggage Mount Only.....\$39.99
 - DMN-K540KM Luggage Mount w/UHF Mount and 13' Cable/PL-259\$61.99
- K550 Mount**
- DMN-K550 Luggage Mount Only.....\$44.99
 - DMN-K550KM Luggage Mount w/UHF Mount and 13' Cable/PL-259\$69.95

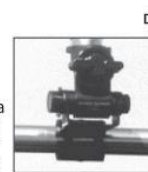

DMN-K540



DMN-K515SNMO



DMN-K550KM

Need help with your project? Call the tech line at 330-572-3200!



COMPACTenna

DX Engineering is pleased to carry COMPACTenna's line of small, multi-band antennas (7" to 20" tall) designed for high performance on a small 3' x 3' metal ground plane with no tuning required of the antenna. Small enough to fit in the attic, a closet or outside without drawing attention, they're a smart choice for HOAs, condos, apartments, or anywhere you—or your neighbors—don't want large antennas. Mounted on vehicles, these antennas can provide easier passage into a garage or drive-thru. Choose from single-band, dual-band, tri-band and scanner antennas. The SCAN-III antenna (100-1,500 MHz) is optimized for public service-safety and government frequency bands. The Ultimate 220 MHz Antenna (CAN-220MAX) offers maximum gain, higher power handling, and low SWR.



CAN-220MAX



CAN-COUNTERPOISE

- CAN-220MAX Ultimate 220 MHz Antenna, 9" Tall, 65W.....**\$139.00**
- CAN-2M-220-440 2M/220/440 Tri-Band Antenna, 7" Tall**\$129.00**
- CAN-2M-440 2M/440 Antenna, 7.5" Tall, 85W 2M; 50W 70cm.....**\$119.00**
- CAN-2M-440PLUS 2M/440 Antenna, 9" Tall, 100W 2M; 75W 70cm.....**\$139.00**
- CAN-SCAN-III Police/Fire/Government Optimized Antenna, 9" Tall**\$149.00**

CompacCounterpoise NMO Mount Base Station Ground Planes

These kits turn your COMPACTenna antennas into sturdy and stealthy base stations. Add the provided radials to optimize signals and SWR for UHF/VHF operation, with a maximum power rating of 250 watts (up to 225 MHz) and 100 watts on higher frequencies. Kits come with 3" diameter mounting plate with mast bracket, clamps, four 18" radials, and stainless steel hardware. They work with many monoband or multi-band NMO-mount antennas, including COMPACTenna's 2M-440, 2M-440PLUS, 2M-220-440, SCAN-III, and the LMR-I Land Mobile Radio Antenna.

- CAN-COUNTERPOISE SO-239, Mounts Antennas from 144 to 512 MHz.....**\$129.00**
- CAN-COUNTERPOISE-N Female, Mounts Antennas from 144-1,000 MHz.....**\$109.00**

LMR-I Land Mobile Radio Antenna

The high-performance, low-profile LMR-I Land Mobile Radio Antenna provides coverage of three optimized frequency ranges: High VHF 136-174 MHz, Low UHF 378-512 MHz, and High UHF 750-960 MHz. With a power rating of 100W VHF/75W UHF and omni-directional coverage, this 9" tall cylindrical radome-style antenna makes a great choice for analog and digital operation modes for Police, Fire, Sheriff, Emergency Medical, State Highway Patrol, Homeland Security, U.S. Federal, Military and Business-Commercial applications. It features a leaf-spring style NMO mount base for standard center-stud style NMO mobile mounts. It may be mounted on a vehicle, or it can be used for base station/repeater operations by adding an optional COMPACTenna CompacCounterpoise.



- CAN-LMR-I Land Mobile Radio Antenna**\$199.00**

Compact Land Mobile Radio Antenna

This 5.25" model has a 100W power rating, covers 162-174 MHz, and makes a good choice for both analog and digital operation modes.

- CAN-168 Land Mobile Radio Antenna**\$280.00**



Monoband Mobile Antennas

These tested and well-built helical-wound mobile whip antennas deliver excellent performance at a friendly price, from the Top Band model through 6M. Capable of a VSWR of 1.5:1 or better, each has a 3/8"-24 mounting stud. Mount not included.

- MKR-12-054 160M Mobile Antenna, 100W.....**\$109.99**
- MKR-12-056 80M Mobile Antenna, 250W.....**\$39.99**
- MKR-12-057 60M Mobile Antenna, 250W.....**\$36.99**
- MKR-12-058 40M Mobile Antenna, 250W.....**\$36.99**
- MKR-12-060 30M Mobile Antenna, 250W.....**\$35.99**
- MKR-12-062 20M Mobile Antenna, 250W.....**\$35.99**
- MKR-12-064 17M Mobile Antenna, 250W.....**\$34.99**
- MKR-12-066 15M Mobile Antenna, 250W.....**\$34.99**
- MKR-12-068 12M Mobile Antenna, 250W.....**\$34.99**
- MKR-12-070 11M Mobile Antenna, 250W.....**\$34.99**
- MKR-12-072 10M Mobile Antenna, 250W.....**\$34.99**
- MKR-12-074 6M Mobile Antenna, 250W.....**\$33.99**

Mounting - There are pros and cons of every antenna mounting location. A glass mount can be removed without leaving a trace, but may compromise antenna gain. Drilling a hole in your roof is the best option for performance, but then...you'll have a hole in your roof. In fact, simply moving your antenna from the front to the back of your vehicle can drastically affect your signal.



Mobile Whip Antenna

DX Engineering's WP-102 is the classic 102" whip, perfect for 10 meter operation. It's made from heat-treated 17-7 PH tapered stainless steel, which resists bending and kinking, while providing good corrosion resistance and minimum distortion. The WP-102 is ideal for mobile and portable operations and for Active Receive Antenna Systems. It's also great for use with mobile antenna tuners. The whip features a 3/8"-24 stud mount.

- DXE-WP-102 Mobile Whip Antenna, Tapered, 1-Piece, Stainless Steel, 8.50' Length, 3/8"-24 Stud**\$32.99**



Hot Rodz® Capacity Hat for Hustler Mobile Antennas

This fully adjustable system attaches directly to your Hustler HF antenna. Hot Rodz improves efficiency, allowing the use of a smaller loading coil for a given frequency band. Other benefits include wider bandwidth and the ability to use a single coil on multiple bands. The Hot Rodz Capacity Hat comes with a precision-machined 6061-T6 aluminum hub with stainless steel set screws and six each of 6 inch, 12 inch and 24 inch stainless steel rods.

- DXE-HR-1P Hot Rodz Capacity Hat for Hustler Mobile Antennas**\$99.99**



Hot Rodz® Capacity Hat for Screwdriver Antennas

This fully adjustable system attaches directly to any screwdriver antenna. Hot Rodz allows you to remove the long whip from your antenna while increasing efficiency, so you can use less coil for any given frequency. The Hot Rodz Capacity Hat comes with a 22 inch tall mast, and six each of the 6 inch, 12 inch and 24 inch stainless steel rods.

- DXE-HR-2P Hot Rodz Capacity Hat for Screwdriver Antennas.....**\$121.99**



Hot Rodz® Capacity Hat Components

Increase the efficiency of your own shortened antenna by building your own Hot Rodz Capacity Hat system. Visit DXEngineering.com for complete details.

- DXE-HRHUB-1P Hot Rodz Hub, Smooth Bore with Set Screws.....**\$32.99**
- DXE-HRHUB-2P Hot Rodz Hub, Threaded Bore.....**\$35.99**
- DXE-RODZ-48P Hot Rodz 48" Stainless Steel Rods.....**\$31.99**
- DXE-RODZ-36P Hot Rodz 36" Stainless Steel Rods.....**\$27.99**
- DXE-RODZ-60P Hot Rodz 60" Stainless Steel Rods.....**\$31.99**
- DXE-RODZ-72P Hot Rodz 72" Stainless Steel Rods.....**\$33.99**

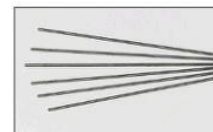

SkyScan VHF/UHF Receive Scanner Antennas



With an RX frequency range from 25-2,000 MHz, this omnidirectional, disc-style, vertically polarized antenna makes a solid choice as a desktop scanner or for SWL. The SkyScan measures 27.56" tall and comes with magnetic base for use on a stationary vehicle. It also includes 13' of RG-58 coaxial cable installed on the base with a BNC male connector on the receive end. Not for use on moving vehicle.

- MKR-11-533 VHF/UHF Desktop Scanner Antenna**\$85.99**

SkyScan VHF/UHF Mobile Receive Scanner Antenna

This antenna features four different length elements tuned for specific frequency ranges from 25-2,000 MHz. The 25.6" tall antenna comes with 3.5" magnetic mount with rubber base padding to protect your vehicle, along with 13' of RG-58 coaxial cable with BNC connector on one end.

- MKR-12-202 VHF-UHF Mobile Scanner Antenna.....**\$35.99**



Preamplifiers for Scanners/Receivers



Get the most out of your scanner or receiver with these well-built wideband preamplifiers from Moonraker. The MKR-20-000 model (MRP 2000) covers 25-2,000 MHz and has a preamplifier gain from 6 to 20 dB. The MKR-20-001 version covers 24-2,300 MHz and features a variable gain control (-10 to +22 dB), and switched band pass filters to minimize interference. Units come with BNC connectors and patch cable. Preamps can be powered by required internal 9V battery or VDC supply.

- MKR-20-000 25-2,000 MHz Scanner Preamp.....**\$82.99**
- MKR-20-001 24-2,300 MHz Scanner Preamp with Gain Control.....**\$109.99**



Most in-stock parts ship throughout the contiguous US in just 1-2 days!



MRM-100S Dual Band Micro-Mag Antenna

For lightning-quick HT operation on the 2M and 70cm bands, Moonraker's magnetic-mounted 19 inch whip antenna gets the job done. It comes with a 13' RG-174 cable terminated to an SMA male for fast connection to almost any modern handheld transceiver. Just pack the MRM-100S Dual Band Micro-Mag Antenna in your car or Go-Kit and you're ready for emergency mobile operation when the need calls.

MKR-12-030 2M/70cm Micro-Mag Antenna\$32.99



Highlander 8 Tapped Mobile Whip Antenna

Machine-wound and coated with heavy-duty Polyolefin for long life, this robust and efficient 250W PEP stainless steel whip is designed to adjust to any portion of 80 through 6 meters, including WARC bands (60M excluded). Band selection is as simple as plugging in a tap. Fine-tuning is accomplished by adjusting the variable-length stainless mini-whip at the top. Bushcomm recommends installing with heavy-duty mounts and springs. Enter "Highlander 8" at DXEngineering.com for more details.



BCM-BU01180 Tapped Mobile Whip Antenna, 5.84'\$419.99

Hustler Standard and Super Resonators

Individual Hustler Resonators are available for 80, 75, 40, 30, 20, 17, 15, 12 and 10 meters. Use these resonators with Hustler's MO-2 or MO-4 mounts, mobile masts, and other accessories to build a custom mobile antenna. Use DX Engineering Hot Rodz® capacity hats and other accessories with these resonators to improve antenna efficiency. Replacement set screws with hex key for all Hustler Resonators (DXE-HUSRES-SSKIT) are now available. Find more Hustler Resonator options at DXEngineering.com. Please note that resonator PEP is reduced for data modes.



Part Number	Band	Power Handling (PEP)	Bandwidth at 2:1 SWR	Price
HSR-RM-80	80M	400 W	25-30 kHz	\$53.99
HSR-RM-80S	80M	1,000 W	50-60 kHz	\$92.99
HSR-RM-75	75M	400 W	50-60 kHz	\$53.99
HSR-RM-75S	75M	1,000 W	50-60 kHz	\$92.99
HSR-RM-40	40M	400 W	40-50 kHz	\$46.99
HSR-RM-40S	40M	1,000 W	50-80 kHz	\$80.99
HSR-RM-30	30M	400 W	50-60 kHz	\$46.99
HSR-RM-20	20M	400 W	80-100 kHz	\$40.99
HSR-RM-17	17M	400 W	120-150 kHz	\$40.99
HSR-RM-15	15M	400 W	100-150 kHz	\$30.99
HSR-RM-12	12M	400 W	90-120 kHz	\$30.99
HSR-RM-10	10M	400 W	150-250 kHz	\$30.99

Replacement Parts for Hustler Resonators		Price
HSR-MO-2	Hustler 54" Folding Mast for Fender/Bumper	\$53.99
HSR-MO-3	Hustler 54" Non-Folding Mast, Marine Apps	\$41.99
HSR-MO-4	Hustler Non-Folding Mast, 22" Total Length	\$35.99
HSR-QD-2	Hustler Stainless Steel Disconnect, 3/8"-24	\$40.99
HSR-49-04-40S	Replacement Whip for RM-40S	\$6.99
HSR-49-04-80S	Replacement Whip/Corona Ball for RM-75S/80S	\$10.99
DXE-HUSRES-SSKIT	4 Replacement 10-32 x 1/8" Set Screws with 3/32" Hex Key for all Hustler Resonators	\$5.99



Mobile Antenna Mounts

HSR-SSM-2	Heavy-Duty Stainless Steel Ball Mount, 2" Diameter.....	\$46.99
HSR-SSM-3	Stainless Steel Spring, 3"	\$46.99
HSR-L-14-144	12' RG-58/PL-259 to Lugs, Coax to Ball Mount	\$16.79
HSR-VP-1	Tri-Band Adapter for HF Mobile Antenna.....	\$12.99
HSR-QD-2	Stainless Steel Quick Disconnect, 3/8"-24	\$40.99
HSR-RSS-2	Stainless Steel "Resonator" Impact Spring	\$27.99
HSR-MBM	Super Magnetic Mount, 16' Coax, 3/8"-24 Antenna	\$36.99

Larsen VHF/UHF Mobile Antennas, Mounts, and Brackets



DX Engineering is pleased to once again carry gear from Larsen Antennas (a Pulse brand), a company that has shipped more than two billion antennas over decades of service to the amateur radio community. Choose from 15 models of mono-, dual-, and tri-band antennas, either with an NMO or glass mount. Glass mounts are a solid option if you want to avoid drilling or if your vehicle has a non-metallic body. Some selections come with 14' coaxial cable assemblies with PL-259 connectors.



LSN-NMOQW144	21" Stainless Whip, 144-152 MHz, 1/4 Wave, NMO Mount.....	\$20.99
LSN-NMOQSPEC	22" Stainless Whip, 136-960 MHz, 1/4 Wave, NMO Mount.....	\$26.99
LSN-NMOQSPECB	22" Black Whip, 136-960 MHz, 1/4 Wave, NMO Mount	\$32.99
LSN-NMO150C	51.5" Stainless Whip, 144-174 MHz, 5/8 Wave, NMO Mount ..	\$48.99
LSN-NMO150450800	Chrome Tri-Band, 150-165/450-470/806-940 MHz, NMO Mount.....	\$49.97
LSN-NMO150B	51.5" Black Whip, 144-174 MHz, 5/8 Wave, NMO Mount	\$53.99
LSN-NMO50C	52.5" Stainless Whip, 47-54 MHz, 1/4 Wave, NMO Mount.....	\$66.99
LSN-NMO220C	30" Stainless Whip, 220-225 MHz, 5/8 Wave, NMO Mount.....	\$68.99
LSN-NMO50B	52.5" Black Whip, 47-54 MHz, 1/4 Wave, NMO Mount	\$72.99
LSN-NMO2-70SH	19" Stainless Whip, 144-148 /440-450 MHz, NMO Mount	\$74.99
LSN-NMO220B	30" Black Whip, 220-225 MHz, 5/8 Wave, NMO Mount	\$77.99
LSN-NMO2-70C	34.5" Chrome Whip, 144-148 /440-450 MHz, NMO Mount, with Closed Center Coil	\$119.99
LSN-NMO2-70B	34.5" Black Whip, 144-148/440-450 MHz, NMO Mount, with Open Center Coil	\$122.99
LSN-KG144UDPL	47" VHF, 144-160 MHz, Glass Mount, with 14' RG-58 Cable ...	\$199.99
LSN-KG2-70CXPL	32.75" VHF/UHF, 144-148 /442-448 MHz, Glass Mount, with 14' RG-58 Cable	\$251.99
LSN-NMOCAPB	Replacement Rain Cap for NMO Mount	\$8.69
LSN-KGREINSTALL	Reinstallation Kit for KG Glass Mount Antennas	\$18.99

27-30 MHz Mobile Whip Antennas

Great for 10 or 11 meter use, these base-loaded whip antennas measure 52.5" and fit nicely on a companion Larsen mount of your choice (not included), allowing you to run up to 150 watts of RF power. These loaded 1/4 wave antennas provide 2 dBi gain. Base fits just about any NMO type antenna mount.

LSN-NMO27B	Black Whip 27-30 MHz Mobile Whip Antenna	\$70.99
LSN-NMO27C	Stainless Steel Whip 27-30 MHz Mobile Whip Antenna	\$64.99

Base Station Antenna Adapter Kit

This special mount and bracket converts a VHF or UHF mobile antenna into a base station antenna. The antenna connector is a UHF mount. Kit includes an NMO mount adapter, so either type of mobile antenna mount style may be converted to base operations. The underside of the mount is an integral SO-239 connector for the user-supplied coax.

LSN-BSAKIT	Base Station VHF/UHF Antenna Adapter Kit.....	\$97.99
------------	---	---------

Mobile Antenna Mounts

Choose from a range of premium-quality antenna mounts and brackets from Larsen, including NMO Round Magnet Mount with RG-58 Cable Assembly (PL-259 Connectors); L Mount Right Angle Brackets for Fender or Flat Surface; NMO Trunk Lid Mount with RG-58 Cable Assembly (PL-259 Connectors); NMO Mount for Mid-Thickness Metals with RG-58 Dual-Shield Cable; PO Magnet Mount with RG-58 Cable Assembly (SO-239 Female Connectors); and more.

LSN-NMOK	NMO Mount, 17' RG-58 Cable, PL-259.....	\$35.99
LSN-NMOMMRPL	NMO Round Magnet, 12' RG-58 Cable, PL-259	\$69.99
LSN-TMB34	L Mount Right Angle Bracket, Hole for NMO	\$9.99
LSN-NMOHF	NMO Mount, High Frequency, Mount Only	\$13.99
LSN-NMOKHFCXPL	NMO Mount, High Frequency, 17' RG-58 Cable, PL-259.....	\$39.63

Enter "Larsen Mount" at DXEngineering.com for the entire lineup.



Antenna Mount Adapters

Stretch your mobile antenna budget by using NCG Antenna Mount Adapters. Instead of buying a new mount for your new antenna, you can repurpose your existing mount using these adapters. Made from top quality materials, these no-compromise mounts will speed up new antenna installs.

NCG-AD-10N	Antenna Mount Adapter, Type N Female to NMO	\$24.99
NCG-AD-15M	Antenna Mount Adapter, NMO to UHF	\$22.99
NCG-AD-25M	Antenna Mount Adapter, UHF to NMO	\$16.99
NCG-AD-35M	Antenna Mount Adapter, UHF to 3/8"-24	\$19.99

Join our crew on Facebook for news and exclusive deals!

100 Antennas: HT, Portable & Mobile

HT Antennas



Maximize your HT or scanner performance. Comet's HT antennas offer significant gain improvements over your original antenna and are super-rugged, making them perfect for use in the field. Many have extended receive capabilities—visit DXEngineering.com for all of the specs. Available in multiple connector types, sizes and band coverage, Comet Antennas are excellent replacement antennas for your scanner or HT.



Part Number	Description	Length	Gain	Price
CMA-SMA-24	Dual-Band, Flexible, SMA Male, 20 W Power Rating	15.75"	2.1 dBi (2M) 3.5 dBi (70cm)	\$24.99
CMA-SMA-24J	Dual-Band, Flexible, SMA Female, 20 W Power Rating	17"	2.1 dBi (2M) 3.5 dBi (70cm)	\$24.99



Dual-Band HT Antenna

This quality-made 3" stubby-type SMA male antenna for 2M and 70cm offers the convenience of a short antenna with reliable performance for many handhelds from leading manufacturers, such as Icom, Yaesu, Kenwood, and Alinco. Covered with a flexible rubber sleeve, the lightweight "rubber duck" antenna handles up to 5 watts of power, and its unobtrusive stature makes it ideal for easy walking and talking wherever you take your HT rig.



CMA-SMA-209 Dual-Band Stubby HT Antenna.....\$17.99



Extra-Long Telescopic Antennas

If you're building a dipole, screwdriver, base or mobile antenna, MFJ offers you a great starting point. Made from stainless steel with standard 3/8"-24 mounts, these antennas are also perfect for traveling, DXpeditions, vacations and Field Day.



MFJ-1976 Telescopic Antenna, 10'.....\$49.95
 MFJ-1977 Telescopic Antenna, 12'.....\$59.95
 MFJ-1979 Telescopic Antenna, 17'.....\$69.95



HT Antennas

By upgrading your HT's original-equipment antenna, you can get significant coverage gains. MFJ offers some great options to increase the gain of your handheld. These durable antennas are well suited to field conditions.



Part Number	Description	Length	Price
MFJ-1714	Monoband, Telescopic, 1/2-Wave on 2 Meter, BNC	40"	\$19.95
MFJ-1714S	Monoband, Telescopic, 1/2-Wave on 2 Meter, SMA Male	40"	\$19.95
MFJ-1717S	Dual-Band, Flexible, 1/4-Wave on 2 Meter, 1/2-Wave on 70cm, SMA Male	15.75"	\$39.95

Mobile Antennas

Durable, powerful, mobile. MFJ gives you excellent, high-performance mobile antennas that will stand up to miles of use. Whatever band you choose, MFJ Mobile Antennas are designed with the serious operator in mind. For complete specs on any MFJ mobile antenna visit DXEngineering.com.

Mobile HamTenna Whips, 3/8"-24

MFJ-1675T 75M.....\$39.95
 MFJ-1640T 40M.....\$29.95
 MFJ-1620T 20M.....\$29.95
 MFJ-1617T 17M.....\$21.95
 MFJ-1615T 15M.....\$21.95
 MFJ-1610T 10M.....\$21.95
 MFJ-1606T 6M.....\$21.95
 MFJ-348T Trunk/Hatchback Mount for MFJ-1600 Series.....\$59.95

2M/70cm Mobile Antennas

MFJ-1722S UltraLite Magnet Mount, SMA, 20".....\$29.95
 MFJ-1734 Glass Mount, with Coax, 26".....\$59.95
 MFJ-1724B Magnet Mount, BNC HT Adapter, 26".....\$29.95
 MFJ-1412B 200 Watts, Black Finish, 40".....\$34.95
 MFJ-1414 200 Watts, 58.5".....\$39.95
 MFJ-1432 150 Watts, 62.5".....\$69.95
 MFJ-1432B 150 Watts, 62.5".....\$69.95

Mobile Antennas from MFJ

MFJ-1728B 6M/2M Mobile Antenna, Magnet Mount, BNC HT Adapter.....\$39.95



HT Antennas

The rubber duckie antenna packaged with your HT may be keeping your handheld from operating at its full potential. Knowing this, Diamond Antenna brings you dual and triple band antennas that offer better performance. As proof, Diamond rates its antennas against the original HT manufacturer's antenna to show you a relative gain improvement over your HT's (or scanner's) stock performance.

Whether you want a simple replacement for a broken HT antenna or you are looking for significantly improved reception, Diamond Antennas has a solution.

Part Number	Description	Length	Gain	Price
DMN-RH77CA	Dual-Band, Flexible, BNC Male, 10 W, Extended Receive to 900 MHz	15"	6 dB	\$22.99
DMN-RHF40	Dual-Band, Flexible, BNC Male, 10 W, Extended Receive to 900 MHz	16"	6 dB	\$27.99
DMN-SRH519	Dual-Band, Flexible, SMA Male	7.75"	3 dB	\$26.95
DMN-SRH77CA	Dual-Band, Flexible, SMA Male, 10 W, High Gain & Extended Receive to 900 MHz	15"	6 dB	\$22.99
DMN-SRJ77CA	Dual-Band, Flexible, SMA Female, 10 W, Extended Receive to 900 MHz	15"	6 dB	\$24.99
DMN-SRHF40	Dual-Band, Super-Flexible, SMA Male, 10 W, Extended Receive to 900 MHz	16"	6 dB	\$26.99
DMN-SRH320A	Tri-Band, Flexible, SMA Male, 10 W Power Rating		4 dB	\$46.99
DMN-SRH789	Dual-Band, Scanner Antenna, Telescopic, SMA Male, 10 W, 85-300 MHz and 300-1100 MHz	31.7"	—	\$33.99



HT Antenna Adapters

Upgrading your HT with a new antenna may require an adapter. Diamond Antennas comes through with a line of adapters well suited to handheld use. DX Engineering carries a wide range of adapters for practically every Ham Radio application. Type keyword "Adapter" into the search box at DXEngineering.com to see more.



DMN-SMAJ-SMAJ DMN-BNCJ-SMAP

Part Number	HT Connector	Antenna Connector	Price
DMN-BNCJ-SMAP	SMA Male	BNC Female	\$9.99
DMN-BNCP-SMAJ	BNC Male	SMA Female	\$9.99
DMN-SMAJ-SMAJ	SMA Female	SMA Female	\$9.99

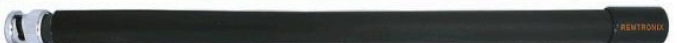

Remtronix Flexible HT and Scanner Whip Antennas

From the handheld transceiver experts at Alinco comes two new whip antennas that provide a substantial range improvement over factory standard portable handheld radio and scanner antennas. Choose from the 8" rubber VHF/UHF/800 MHz antenna with BNC male connector or the 8.5" rubber VHF/UHF/800 MHz antenna with SMA male connector. Features include 5W power rating, flexible whip rubber ducky design, and excellent performance with handheld scanners and HTs.

ALO-REM-842B VHF/UHF/800 MHz Whip Antenna, 8", BNC Male.....\$31.00
 ALO-REM-842S VHF/UHF/800 MHz Whip Antenna, 8.5", SMA Male.....\$31.00

DUOSAT Handheld Portable Satellite Antenna

EAntenna's dual band DUOSAT antenna has been designed for effective handheld portable satellite operation. Weighing only 800 grams, it features 3 LFA elements in VHF and 5 LFA elements in UHF, low noise, and 144-146 MHz (VHF)/432-438 MHz (UHF). Made from sturdy aluminum with stainless steel fittings, the DUOSAT closed loop LFA antenna has been precision-engineered to deliver maximum gain and efficiency. Duplexer not included.



EAN-R2010254 VHF/UHF LFA Yagi, DUOSAT Antenna.....\$169.99

Check out our YouTube channel for in-depth tech tips and product demos!

Coaxial Lightning and Surge Protectors



NexTek's DC block and DC pass arrestors provide dependable, long-lasting wideband performance to protect equipment from electromagnetic pulse or power surges, while ensuring low SWR/insertion loss and no degradation of signal. Its PTI-BB50 Series DC Block 50 Ω devices incorporate a blocking capacitor and gas discharge tube to provide isolation with no DC continuity between the two center pins. Rated for a maximum RF power of 2.0 kW, this series is designed to pass RF frequencies and block all DC. PTC Series DC Pass bulkhead-mount 75 Ω arrestors feature a 90V fixed gas-discharge tube and are designed to pass DC current. The rugged, waterproof arrestors deliver bi-directional protection and boast a frequency range of 2.5 or 3.0 GHz depending on model. The 50 Ω, bulkhead-mount PTR Series DC Pass arrestors feature a replaceable gas-discharge tube; a frequency range up to 3.2 GHz; the ability to handle a maximum current surge of 50 kA; 240W, 550W, or 2,900W RF power rating; and bi-directional protection. Enter "NexTek" at DXEngineering.com for more details.



NTK-PTI-BB50NFF NTK-PTCF-02-LK

NTK-PTCF-02-LK	DC Pass, PTC Series, 2.5 GHz, 25W RF Power, with Bracket	\$59.00
NTK-PTCF-03	DC Pass, PTC Series, 3.0 GHz, 25W RF Power	\$55.00
NTK-PTRONFONF23S	DC Pass, PTR Series, 3.2 GHz, 230V, 240W RF Power, Bi-Directional.....	\$107.00
NTK-PTRONFONF80S	DC Pass, PTR Series, 3.2 GHz, 800V, 2,900W RF Power , Bi-Directional	\$107.00
NTK-PTRONMONF35S	DC Pass, PTR Series, 3.2 GHz, 350V, 550W RF Power, Bi-Directional.....	\$107.00
NTK-PTI-BB50NFF	DC Block, PTI-BB50, 1.5-1,000 MHz, 2 kW Input Power, N-Type Female.....	\$93.00
NTK-PTI-BB50NMS	DC Block, PTI-BB50, 1.5-1,000 MHz, 2 kW Input Power, N-Type Male	\$97.00

Broadband Coaxial Lightning Protectors



These 50 Ω, DC-blocked protectors are great for general, single transmitter use in the 1.5 to 700 MHz frequency ranges. Available with either a bulkhead or flange mount, Polyphaser's Lightning Protectors use a gas tube design that has no DC continuity between the center pins. Polyphaser's Multi-Strike products pass all RF frequencies while blocking all DC—offering excellent protection from voltage spikes.



PPR-IS-50UX-C0	UHF Female, Flange, 2,000 W, 1.5-700 MHz	\$82.99
PPR-IS-50NX-C0	Type N Female, Flange, 2,000 W, 1.5-700 MHz.....	\$78.99
PPR-IS-B50LN-C0	Type N Female, Bulkhead, 2,000 W, 1.5-700 MHz.....	\$84.99
PPR-IS-B50LU-C0	UHF Female, Bulkhead, 2,000 W, 1.5-700 MHz	\$106.99
PPR-IS-B50HU-C0	UHF Female, Bulkhead, 3,000 W, 1.5-700 MHz	\$127.99



Protect your station's sensitive electronics from damaging spring and summer lightning strikes with Diamond Antenna SP-Series Lightning Arrestors. Choose the coaxial connection scheme and RF power rating that suits your needs. They're designed to pass DC current, so you can install them inline with external devices requiring coaxial DC power-feed.



Part Number	Description	Price
Lightning Arrestors		
DMN-SP3000	DC-3000 MHz, 200 W Max, Type N Female to Type N Female	\$39.95
DMN-SP3000P	DC-3000 MHz, 400 W Max, Type N Female to Type N Male	\$41.99
DMN-SP3000W	DC-3000 MHz, Waterproof, Type N Female to Type N Female	\$41.99
Lightning Surge Protectors		
DMN-SP1000	DC-1000 MHz, 400 W Max, UHF Female to UHF Female	\$31.99
DMN-SP1000PW	DC-1000 MHz, 400 W Max, UHF Female to UHF Male	\$34.99

Receive Feedline Surge Protector

This unique in-line design is impedance matched to 75 Ω and virtually transparent to both analog and bi-directional signals from DC to 1.0 GHz. The patented and proprietary gas tube construction has an integral failshort mechanism for a power-cross condition that shunts both your cable's center conductor and sheath for a common path to ground. The protection element resets after each over-voltage incident.



DXE-RLP-75FF	Receive Feedline Surge Protector, 75 Ω, DC Pass, F Connectors	\$22.99
--------------	---	----------------



Utility Enclosure Package

The Utility Enclosure Package is a high-impact thermoplastic enclosure ideal for outdoor mounting of all types of lightning protectors or other equipment. Its weathertight design protects the components from rain and direct water spray. It resists degradation from environmental contaminants, chemical fertilizers and insecticide sprays that can ruin metallic housings.

The thermoplastic housing and wire entrance grommet material are fire retardant and UV stabilized. The enclosure can be painted with latex or oil base paints if needed to blend it in with its location. The kit includes an aluminum mounting plate for attaching your lightning protectors and ground strap.

Mounting hardware, mounting plate and four weathertight large feed-through grommets for RG-213 and LMR-400 sized cable are included. Optional feed-through grommets for smaller cables are available.

DXE-UE-2P	Utility Enclosure Package, 13" W x 14" H x 4" D	\$92.99
DXE-CFT-1P	Large Cable Feed-Through Grommets, Pack of 6.....	\$19.99
DXE-CFT-2P	Small Cable Feed-Through Grommets, Pack of 6.....	\$19.99

Flange Mounting Brackets

These brackets convert many popular stud-mount lightning protectors, like Alpha Delta's Coaxial Surge Protector, to a flange mount. The conversion makes them easier to mount inside DX Engineering's UE-2P Utility Enclosure. Hardware is included.



DXE-ATT3G-BRKT	Flange Mounting Bracket, Straight	\$10.99
DXE-RCT-BRKT	Flange Mounting Bracket, Right Angle	\$9.99

Transi-Trap Broadband Coaxial Surge Protectors



These gas-tube surge arrestors protect sensitive equipment from excessive voltage and current caused by static buildup or a lightning strike. The 50 Ω DC voltage pass-through design is perfect if you're using coaxial cable to carry both RF and DC voltage, like in an antenna switch. These protectors use a replaceable Arc-Plug™ cartridge that you can change in the field without tools. They feature a 1/4"-20 mounting stud for easy installation.

The Defense Logistics Agency has assigned an NSN of 5920 01 5470278 to the model TT3G50 Coax Surge Protector and NSN 5325 01 5466841 to the 3G50 Arc-Plug cartridge for use in all U.S. Military and NATO applications worldwide.

Part Number	Mount	Connector	Frequency	Power Handling	Price
ALF-ATT3G50	Stud	Type N	3 GHz	200 Watts	\$79.99
ALF-ATT3G50HP	Stud	Type N	3 GHz	2,000 Watts	\$79.99
ALF-ATT3G50F	Stud	F Connector	3 GHz	200 Watts	\$79.99
ALF-ATT3G50FHP	Stud	F Connector	3 GHz	2,000 Watts	\$79.99
ALF-ATT3G50U	Stud	SO-239	500 MHz	200 Watts	\$69.99
ALF-ATT3G50UHP	Stud	SO-239	500 MHz	2,000 Watts	\$69.99
ALF-AT3G50UBXL	Bulkhead	SO-239	500 MHz	200 Watts	\$79.99
ALF-ATT3G50UBHP	Bulkhead	SO-239	500 MHz	2,000 Watts	\$79.99
ALF-AT3G50UM90	90°	SO-239 & PL-259	500 MHz	200 Watts	\$79.99
ALF-AT3G50UM90HP	90°	SO-239 & PL-259	500 MHz	2,000 Watts	\$79.99
ALF-3G50		Replacement Arc-Plug		200 Watts	\$14.99
ALF-3G50HP		Replacement Arc-Plug		2,000 Watts	\$14.99

Orders by 10 pm ET ship the same day. See pg. 74 for details.

DX ENGINEERING

Ladder Line Surge Protector

At DX Engineering, we take customer feedback seriously. It's how some of our most useful products come to light. So when active Hams asked us about developing a surge protector to use with their 300 Ω and 450 Ω ladder line fed antennas, we went to work. The result is the DX Engineering Ladder Line Surge Protector, a device that's ready to be placed in line with your balanced feedline antenna system and connected to a ground rod. Compared to coaxial protectors, the DXE-LLSP uses much larger capacitors, resistors and gas discharge tubes (rated to handle 5 kW) on each leg of the ladder line to offer excellent surge protection capabilities. This protector easily handles over 5,000W of RF power at high SWR, sustains multiple minor surges, and bleeds off static charge collected on the antenna from wind-driven sand, rain and snow. The unit works with 300/450 Ω ladder line and 600 Ω open-wire feeder line.



DXE-LLSP Ladder Line Surge Protector\$85.99

DX ENGINEERING

Rotator Control Line Protector

Protect your control lines using this unit's eight individually shunt-protected terminals. When the voltage spikes above 82 Vdc in either polarity, the Rotator Control Line Protector automatically shunts the circuit to ground using an MOV for maximum surge protection.



The protector is housed in a weatherproof metal enclosure with an integrated mounting stud, which makes it easy to attach to a tower leg or ground rod. Terminal gaskets help prevent any moisture from entering the housing.

DXE-IS-RCT Rotator Control Line Protector\$189.99
DXE-RCT-BRKT Right Angle Flange Mounting Bracket.....\$9.99



PARADAN radio

Antenna Disconnect Actuator

This small, handy device can play a big part in protecting your station. Install Paradan's Antenna Disconnect Actuator in the coaxial cable that feeds the antenna. When power from your transceiver or station power supply is turned off, it automatically disconnects the antenna from your station and grounds the antenna feedline, reducing the chance of station damage from static-discharge, surges and lightning pulse effects. You'll never again have to worry about remembering to unplug the system. Further safeguards are provided via a gas discharge tube on the antenna coax input which protects the radio from lightning pulse damage while operating. The relays have diode protected coils to eliminate reverse spikes. The actuator's water-resistant enclosure may be installed in the shack at the output of the transceiver, amplifier or tuner, or outdoors in line with the antenna coaxial cable. The unit handles 1,500 watts of RF from 1.8 to 50 MHz. The PDN-P-ADA-2 model automatically disconnects and isolates any radio equipped with two antenna ports and grounds both antenna SO-239 coaxial connectors. The two radio SO-239 connectors may also be used for two separate transceivers or receivers.



PDN-P-ADA-1 Antenna Disconnect Actuator\$130.00
PDN-P-ADA-2 Dual Antenna Disconnect Actuator\$200.00

Mid-Span Coaxial Grounding Kits

Easily install a ground lug virtually anywhere along your coaxial cable run. These kits are a great solution if you want to ground your cable in an atypical location. Simply strip back the cable jacket, tighten down the pre-formed metal strap and secure your ground lugs. Make sure to weatherproof your grounded section after you've installed one of these kits to prevent water ingress into the cable. Check out the Cleaning and Weatherproofing section of this catalog for tape and other supplies.



TMV-GK-S400TT Mid-Span Coaxial Grounding Kit, for LMR-400 Size Cable\$33.99
TMV-GK-S600TT Mid-Span Coaxial Grounding Kit, for LMR-600 Size Cable\$33.99

LT Coaxial Surge Protector



Don't live in fear of lightning strikes. This unit is designed to protect your delicate and expensive equipment from lightning-induced voltage spikes. It covers frequencies from DC to 30 MHz and handles 200 watts. In-line installation is easy with two SO-239 connectors.



ALF-LT LT Coaxial Surge Protector\$39.99
ALF-LT-ARC-PLUG Replacement Arc Plug[®] for ALF-LT\$21.99

DX ENGINEERING

Coaxial Cable Grounding Brackets

The CGB-Series Coax Grounding Brackets are designed for grounding coaxial cable shields. The stainless steel bracket is supplied with a stainless steel V-bolt and hardware in your choice of two sizes for a solid connection to a tower leg or mast. Each bracket has holes for bulkhead connectors or chassis mount connectors, listed below.



Two DXE-UHF-FDFB shown mounted to a DXE-CGB-150 using the hardware kit DXE-FSM-HWK

The Grounding Bracket is an ideal junction point for the coax pigtailed that form the rotor loop to connect to the downleads. The bracket can also be used at the base of the tower to provide a solid grounding point before the coax cable is routed away from the grounded tower. The bracket has serrated teeth to bite through paint and corrosion.

- DXE-CGB-200 Grounding Bracket, Fits 1" to 2" OD Tube\$22.99
- DXE-CGB-150 Grounding Bracket, Fits 1" to 1.50" OD Tube\$21.99
- DXE-363-SST SO-239, Bulkhead Connector with Socket Hardware\$11.99
- DXE-UHF-FDFB-KIT SecureMount™ Bulkhead Connector and Hardware Kit\$17.48
- DXE-1023-2 Type N Double Female Bulkhead Adapter, Pack of 2\$34.99



Ground Braid Assemblies

These are available preassembled with lugs for both #10 and 1/4 inch bolt sizes. A grounding strap is ideal for grounding a rig, amp, etc. to a copper strip running behind the desk; the strip becomes the central ground point for the equipment. This central ground can be routed away with heavy copper strap to join any other similarly protected branches for single point grounding (SPG) lightning protection. For indoor use.

DX ENGINEERING

Assemblies with 1/2 Inch Wide Braided Strap		
DXE-TCB05-RT01	#10 Ring Lugs, 1'	\$14.59
DXE-TCB05-RT03	#10 Ring Lugs, 3'	\$16.59
DXE-TCB05-RT06I	#10 Ring Lugs, 6"	\$14.25
DXE-TCB05-RT09I	#10 Ring Lugs, 9"	\$15.69
DXE-TCB05-RT05	#10 Ring Lugs, 5'	\$19.99
DXE-TCB05-RT10	#10 Ring Lugs, 10'	\$23.99
DXE-TCB05-RT18I	1/4" Ring Lugs, 18"	\$15.59
DXE-TCB05-RT24I	1/4" Ring Lugs, 2'	\$15.99
DXE-TCB05-RT36I	1/4" Ring Lugs, 3'	\$18.89
3/4 Inch Wide Braided Strap		
DXE-TCB075-RT18I	1/4" Ring Lugs, 18"	\$16.09
DXE-TCB075-RT24I	1/4" Ring Lugs, 2'	\$16.59
DXE-TCB075-RT03	1/4" Ring Lugs, 3'	\$16.69
Assemblies with 1 Inch Wide Braided Strap		
DXE-TCB10-RT06I	1/4" Ring Lugs, 6"	\$15.49
DXE-TCB10-RT09I	1/4" Ring Lugs, 9"	\$15.69
DXE-TCB10-RT01	1/4" Ring Lugs, 1'	\$15.49
DXE-TCB10-RT18I	1/4" Ring Lugs, 18"	\$16.79
DXE-TCB10-RT24I	1/4" Ring Lugs, 2'	\$17.49
DXE-TCB10-RT03	1/4" Ring Lugs, 3'	\$19.19
DXE-TCB10-RT05	1/4" Ring Lugs, 5'	\$23.99
DXE-TCB10-RT10	1/4" Ring Lugs, 10'	\$31.99



Copper Strap to Tower **DX ENGINEERING**

The TK clamp series has a stainless steel plate to go between the copper strap and galvanized tower leg to prevent corrosion due to dissimilar metals. For use with tower leg diameters from 0.625 inches to 3.25 inches.

- DXE-TK-1A Strap to Tower Leg Ground Clamp, 0.625" to 1.25"\$13.49
- DXE-TK-2A Strap to Tower Leg Ground Clamp, 1.25" to 2.25"\$10.29
- DXE-TK-3 Strap to Tower Leg Ground Clamp, 2.25" to 3.25"\$10.29



Need advice? 1-330-572-3200 or DXEngineering@DXEngineering.com



CADWELD® Exothermic Welding System

The ideal way to secure a copper wire to a ground rod is by welding it securely to the top. The problem is, many of us don't have easy access to a welder. Erico's CADWELD process lets you make copper-to-copper or copper-to-steel electrical connections without the need for outside heat or power sources. The result is a permanent bond that won't loosen or corrode over time. Though it's relatively straightforward, we strongly recommend that you read and understand the CADWELD process before ordering. More One Shot modules available at DXEngineering.com.



Part Number	Wire Connections	For Rod OD	Fits AWG (Stranded)	Fits AWG (Solid)	Price
CADWELD One Shot Modules					
ERO-GR1-141G	1	1/2"	8	8, 6	\$19.15
ERO-GR1-141L	1	1/2"	6, 4	4, 3	\$19.15
ERO-GR1-161G	1	5/8"	8	8, 6	\$19.15
ERO-GR1-161L	1	5/8"	6, 4	4, 3	\$21.05
ERO-GR1-161V	1	5/8"	3, 2	2, 1	\$22.19
ERO-GT1-141G	2	1/2"	8	8, 6	\$21.69
ERO-GT1-141L	2	1/2"	6, 4	4, 3	\$21.69
ERO-GT1-141V	2	1/2"	3, 2	2, 1	\$27.79
ERO-GT1-161G	2	5/8"	8	8, 6	\$22.19
ERO-GT1-161L	2	5/8"	6, 4	4, 3	\$22.19
ERO-GT1-161V	2	5/8"	3, 2	2, 1	\$25.55
CADWELD Mold to Ground Bar					
ERO-GRT-14A1T	1	1/2"	—	2	\$224.99
ERO-GRC-161T	1	5/8"	—	2	\$224.99
ERO-GRC-181T	1	3/4"	—	2	\$224.99
CADWELD Molds, General Use					
ERO-TAC-1T1T	Tee			2	\$224.99
ERO-PCC-1T1T	Flyway			2	\$224.99
ERO-XAC-1T1T	X			2	\$224.99
ERO-XBC-1T1T	Stacked X			2	\$224.99
ERO-LAC-1TCE	Cable to Lug/Bus Bar			2	\$224.99
ERO-T320	Specialized Flint Igniter for CADWELD System				\$19.25

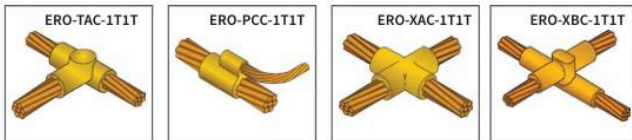

Copper-Bonded Ground Rods

Properly ground your station with these 99.9% pure electrolytic copper coated ground rods. The rods feature a high carbon steel core to ensure that they won't bend or distort while being driven into the Earth.

Part Number	OD	Length	Price
ERO-613840	0.358"	4'	\$61.99
ERO-613852	0.358"	5'	\$19.99
ERO-613880	0.358"	8'	\$29.49
ERO-611360	0.504"	6'	\$29.55
ERO-615840	0.560"	4'	\$22.49
ERO-615880	0.560"	8'	\$39.99
ERO-615800	0.560"	10'	\$50.99
ERO-613460	0.681"	6'	\$49.99
ERO-613480	0.681"	8'	\$64.99

Ground Clamps and Connectors

Solid mechanical connections are critical in a grounding system. These clamps aren't your basic hardware store variety; they are specifically made for precision electrical applications.

ERO-CP34	Ground Clamp, 1/2"-3/4" Rod to Cable, Bronze	\$5.79
ERO-CP38	Ground Clamp, 3/8" Rod to Cable, Bronze	\$5.59
ERO-CP58	Ground Clamp, 1/2"-5/8" Rod to Cable, Bronze	\$5.29
ERO-MBNC82	Mesh Bonding Network Connector, 8 AWG	\$10.69



DX ENGINEERING

Copper Ground Bus Wall Mount

As the foundation of your single-point ground system, DX Engineering's Copper Ground Bus Wall Mount is made from heavy-gauge tempered copper. That means it is strong enough to handle the weight of long cable runs. Can be installed indoors or outdoors, and includes mounting hardware. The bracket has plenty of room for multiple PolyPhaser flange-mount or Alpha-Delta TT/ATT3G50 series coaxial surge protectors, find full dimensions at DXEngineering.com.

DXE-GBWM-W	Copper Ground Bus Wall Mount, 10.8"	\$70.99
DXE-GBWM-HP	Replacement Hardware Pack	\$20.99

Copper Ground Bar

Make sure all your grounds are at equal potential. A near-zero voltage differential ensures a uniform path to ground, which helps protect you and your equipment. This 1/4" thick bar is an excellent start to your single-point grounding system.



ERO-EGBA14210JF	Copper Ground Bar, 2" x 10"	\$91.99
-----------------	-----------------------------	----------------

DX ENGINEERING	Band Clamps with Stud	Pack of 2
	DXE-ECLS-050 0.500" OD Tube	\$16.49
	DXE-ECLS-062 0.625" OD Tube	\$16.49
	DXE-ECLS-075 0.750" OD Tube	\$16.49
	DXE-ECLS-087 0.875" OD Tube	\$17.59
	DXE-ECLS-100 1.000" OD Tube	\$17.69
	DXE-ECLS-125 1.250" OD Tube	\$18.99
	DXE-ECLS-150 1.500" OD Tube	\$18.99
	DXE-ECLS-175 1.750" OD Tube	\$19.49
	DXE-ECLS-200 2.000" OD Tube	\$19.49
	DXE-ECLS-225 2.250" OD Tube	\$19.49
	DXE-ECLS-250 2.500" OD Tube	\$19.49
	DXE-ECLS-275 2.750" OD Tube	\$19.99
	DXE-ECLS-300 3.000" OD Tube	\$19.99
	DXE-ECLS-325 3.250" OD Tube	\$19.99

DX ENGINEERING

Exhaust System Grounding Kit

Many modern vehicles have separate fuel injectors and spark coils for each cylinder.

These units can create substantial pulses on the vehicle wiring. Because the exhaust system is bolted directly to the engine and supported by insulated mounts, it can be excited just like an antenna and radiate pulse noise. By using one of our Exhaust Grounding Kits, you may eliminate that last bit of stubborn noise in your mobile installation. The kit includes a stainless steel saddle clamp and stainless steel hardware.



DXE-EGK-200	Grounding Kit for 2" Exhaust Pipe	\$31.99
DXE-EGK-225	Grounding Kit for 2.25" Exhaust Pipe	\$32.99
DXE-EGK-250	Grounding Kit for 2.5" Exhaust Pipe	\$32.99
DXE-EGK-300	Grounding Kit for 3" Exhaust Pipe	\$34.99

DX ENGINEERING

Ground Wire to Copper Ground Rods

The DX Engineering J series clamps are used to connect ground wire to copper ground rods sized from 0.625 inch to 2.25 inches. They accept wire ranging from #2 stranded to #10 solid. These clamps are made of cast bronze and include 18-8 stainless steel hardware.

DXE-J-1	Wire to Rod Transition Clamp, 0.625" to 1.25"	\$16.99
DXE-J-2	Wire to Rod Transition Clamp, 1.25" to 2.25"	\$33.99

DXE-J-1



Ground Strap

DX Engineering offers quality tinned copper braid in 5 widths for grounding applications. It is sold per foot to accommodate almost any project. Very long per-foot lengths may not be continuous—contact Customer Service to discuss your length needs if continuous length is required.

DXE-TCB-038	3/8" wide x 1/32" thick	per foot \$0.85
DXE-TCB-050	1/2" wide x .030" thick	per foot \$1.02
DXE-TCB-063	5/8" wide x .030" thick	per foot \$1.52
DXE-TCB-075	3/4" wide x .040" thick	per foot \$1.87
DXE-TCB-100	1" wide x .045" thick	per foot \$2.25



We're All Elmers Here! Get Expert Support at: Elmer@DXEngineering.com

DX ENGINEERING

Universal Copper Grounding Clamp

Whether setting up permanent grounding at your base station or protecting your portable gear from disaster on Field Day, make sure you have DX Engineering's Universal Copper Grounding Clamps handy. The team at DX Engineering has made these easy-to-use clamps for mounting lightning protectors commonly used for Amateur Radio, including models from PolyPhaser, Alpha Delta and others. The DXE-UCGC-Z mounts up to six surge protectors onto one ground rod, fits common 5/8" through 3/4" diameter ground rods, and is made from 1/16" thick Copper Alloy 110 for maximum conductivity. The clamp's "Z" shape makes installation and removal of coax connectors on protectors easy. For further protection, the clamp can accommodate a solid copper strap from the station's grounding bus bar. Stainless steel hardware is included. For complete details, enter "Z Clamp" at DX Engineering.com.

DXE-UCGC-Z Universal Copper Grounding Clamp **\$59.99**



Flexible Copper Grounding Strap

A critical part of a low inductance ground system, copper strap's larger surface area has lower inductance per foot than equivalent cross-section wire. Use it to tie equipment back to a common ground point. Copper strap should also be used to make a non-resonant counterpoise for towers located on mountaintops or other rocky terrain. The copper straps listed here are 2" wide. The copper straps are also available in 1/2", 1", 1.5", 3", 4" and 6" widths in 25', 50' and 100' lengths at DXEngineering.com.



Part Number	Thickness	Length	Price
GCL-1120-025	0.012"	25'	\$57.99
GCL-1120-050	0.012"	50'	\$90.99
GCL-1120-100	0.012"	100'	\$161.99
GCL-1220-025	0.022"	25'	\$83.99
GCL-1220-050	0.022"	50'	\$147.99
GCL-1220-100	0.022"	100'	\$275.99



DX ENGINEERING

Tinned Copper Radial Wire

Have a ground-mounted vertical antenna? How would you like to benefit from the same long-lasting, high-performance quality wire used by top contesters and DXers around the globe? DX Engineering makes it possible and cost-effective. DX Engineering 16 AWG Tinned Copper Radial Wire is a great choice for high-count, full-size ground radial wire systems that are required for top-performing HF vertical antenna installations, including 4-element Four Square Array Systems, 3-element ProStack Arrays, and 2-element Dual Vertical Arrays. When subjected to a range of soil conditions, DX Engineering's solid copper wire lasts much longer than bare copper, copper-coated steel and aluminum wires. Available in spools of 500, 1,000, 2,500 and 5,000 feet. Note: It is recommended to use Biodegradable Anchor Pins (DXE-STPL-100BD) to hold down bare wire radials.

DXE-TCRW16-500 Tinned Copper Radial Wire, 500' **\$88.99**
 DXE-TCRW16-1000 Tinned Copper Radial Wire, 1,000' **\$209.99**
 DXE-TCRW16-2500 Tinned Copper Radial Wire, 2,500' **\$349.99**
 DXE-TCRW16-5000 Tinned Copper Radial Wire, 5,000' **\$679.99**

Tinned Copper Grounding Wire

DX Engineering now offers Tinned Copper Grounding Wire from Georgia Copper, a company owned by Gary Smith, a licensed Ham with decades of experience upgrading ground systems and firsthand knowledge of what the Amateur Radio community needs. When copper straps can't be used, Georgia Copper's high-quality tinned copper wire is a good choice for grounding tasks, winding large loading, and matching coils for low band vertical antennas where high power handling is required.



GCL-5021-TIN-025 Tinned Copper Wire, 2 AWG, 25' Coil **\$61.99**
 GCL-5021-TIN-050 Tinned Copper Wire, 2 AWG, 50' Coil **\$125.99**
 GCL-5021-TIN-100 Tinned Copper Wire, 2 AWG, 100' Coil **\$249.99**



Flexible Ground Strap Jumpers

Enjoy the advantages of Georgia Copper Flexible Ground Strap Jumpers, instead of wire or cable, for low impedance outdoor or indoor grounding, HF antenna feedpoint and radial system connections. Even after severe weathering, copper ground straps are still effective for low impedance uses. Unlike tinned copper braid, these straps won't hold moisture, disintegrate and increase in impedance over time. The 1" or 0.75" wide, 0.022" thick flexible solid copper straps are pre-cut and punched with 0.250" or 0.28" holes at each end. They're available as two-packs in 6", 12", 24", 36", 48", and 72" lengths, or in a variety pack that contains one piece of each length. Straps can also be cut for your specific low impedance grounding and connection projects.

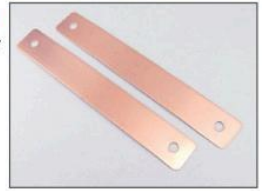

GCL-1006-A-2PK Copper Ground Strap Jumpers, 6", 1" Wide, Pair **\$20.99**
 GCL-1012-A-2PK Copper Ground Strap Jumpers, 12", 1" Wide, Pair **\$22.99**
 GCL-1024-A-2PK Copper Ground Strap Jumpers, 24", 1" Wide, Pair **\$25.99**
 GCL-1036-A-2PK Copper Ground Strap Jumpers, 36", 1" Wide, Pair **\$27.99**
 GCL-1048-A-2PK Copper Ground Strap Jumpers, 48", 1" Wide, Pair **\$30.99**
 GCL-1072-A-2PK Copper Ground Strap Jumpers, 72", 1" Wide, Pair **\$33.99**
 GCL-10VPJ-6PK Copper Ground Strap Jumpers Variety Pack, 6", 12", 24", 36", 48", 72", 1" Wide, One Each **\$78.99**

New! 0.75" Flexible Ground Strap Jumpers with 0.28" Holes

GCL-0706-A-2PK Copper Ground Strap Jumpers, 6", 0.75" Wide, Pair **\$19.99**
 GCL-0712-A-2PK Copper Ground Strap Jumpers, 12", 0.75" Wide, Pair **\$20.99**
 GCL-0724-A-2PK Copper Ground Strap Jumpers, 24", 0.75" Wide, Pair **\$23.99**
 GCL-0736-A-2PK Copper Ground Strap Jumpers, 36", 0.75" Wide, Pair **\$24.99**
 GCL-0748-A-2PK Copper Ground Strap Jumpers, 48", 0.75" Wide, Pair **\$26.99**
 GCL-0772-A-2PK Copper Ground Strap Jumpers, 72", 0.75" Wide, Pair **\$28.99**
 GCL-07VPJ-6PK Copper Ground Strap Jumpers Variety Pack, 6", 12", 24", 36", 48", 72", 0.75" Wide, One Each **\$68.99**

Copper Strap to Copper Strap Clamp



The DXE-MSC-3 bonding clamp is ideal for bonding two copper straps together, for extending an existing run or to add drops to equipment. It accepts ground straps from 1.5 to 3 inches and includes 18-8 stainless steel hardware.

DXE-MSC-3 Multi-Strap Clamp **\$48.99**



Copper Strap to Copper Ground Rod Clamp

This clamp bonds a 0.625 inch ground rod to copper strap. 18-8 stainless steel hardware included.

DXE-58R-112S-2 Strap to Copper Ground Rod Clamp **\$79.99**



Copper Cleaning Kit

Proper preparation of the copper surfaces and application of copper joint compound prior to bonding is essential to maintain the low resistance properties of the strap connection. The copper cleaning kit has everything needed to establish the bond. The kit includes a non-abrasive scrub pad, copper joint compound and complete instructions.

DXE-CCK Copper Cleaning Kit **\$32.99**



SS-30™ Pure Copper Anti-Seize Lubricant



Use Jet-Lube on your taps, lugs, aluminum tubing joints, copper grounding straps, clamps, stainless steel hardware and virtually anywhere you need excellent electrical and RF conductivity. Jet-Lube prevents oxidation and corrosion, which makes it an effective thread lubricant and conductive anti-oxidant termination compound. Its superior anti-seize properties make it a must-have when making metal-to-metal connections. Jet-Lube is safe for aluminum, copper, bronze, steel, tin and galvanized hardware.

JTL-12555 Jet-Lube, 0.25 Lb. Brush-Top Can **\$31.99**
 JTL-12502 Jet-Lube, 0.50 Lb. Brush-Top Can **\$42.99**
 JTL-12504 Jet-Lube, 1.00 Lb. Brush-Top Can **\$64.99**



Grounding and Bonding for the Radio Amateur, 2nd Edition

Author and longtime ham Ward Silver, N0AX, has infused this popular amateur radio reference with answers and easy-to-understand explanations to the voluminous questions he has received from operators. The resulting book contains fresh, up-to-date content; improved drawings; and expanded coverage on key topics. Inside you'll find new details on grounding and bonding for portable, mobile, and upper-floor stations; routing of the ground system; routing of feedlines; and RF management. In addition to covering AC safety, there are expanded details on lightning protection, station antenna systems, single-point ground panels, and much more. An essential addition to any ham's library.

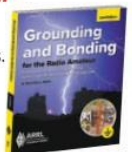

ARR-1496 Grounding and Bonding for the Radio Amateur, 2nd Edition **\$25.95**

Visit DXEngineering.com for the latest limited-time offers and special savings!



Coaxial Connection Waterproofing Kits

Rain and melting snow can be a Ham's worst enemy. Let water and condensation creep into your coaxial cables and you're looking at reduced performance, noise and possible shorts that could damage your expensive equipment. Protect your investment with Coaxial Connection Waterproofing Kits from DX Engineering. Use the kit's self-fusing 3M Temflex™ 2155 Rubber Splicing Tape to create a strong water barrier. Then apply the 3M Vinyl Electrical Tape for added layers of UV protection. Each kit will weatherproof six to ten double connections, depending upon the number of overlapping layers used. Three grades of 3M Vinyl Electrical Tape are offered: Scotch Super 88 Premium or Scotch Super 33 Plus for long-term installations, and economy 3M Tartan 1710 for temporary weather protection.

- DXE-WPCC88-1 Super 88 Electrical Tape, Temflex 2155 Rubber Splicing **\$20.98**
- DXE-WPCC33-1 Super 33+ Electrical Tape, Temflex 2155 Rubber Splicing **\$19.98**
- DXE-WPCC10-1 Tartan 1710 Electrical, Temflex 2155 Rubber Splicing..... **\$13.98**



DXE-RGP-LC



Copper Radio RF Ground Plane Kits

Amateur Radio operators know that radio frequency interference (RFI) can significantly diminish transmitted and received signal quality. DX Engineering's Radio RF Ground Plane Kits offer an effective solution to this common problem by reducing stray RF pickup by indoor radio equipment and interconnecting cables. The kits include a 1/16-inch-thick copper sheet. When placed under your HF radios, microphones and other devices, this RF ground plane, also known as a reference plane, decreases the chances of experiencing RF trouble. The copper sheet is connected to your existing grounding bus.

Used by top contesters and DXers, copper RF ground planes curtail voltage differences between pieces of equipment and associated currents that cause RF interference to transceivers, microphones, tuners, amplifiers, computers and other electronic equipment. Further, placing audio and data cables directly on the metal surface can lessen their ability to pick up RF. DX Engineering Radio RF Ground Plane Kits come with either a 13" x 10", 16" x 16", or 20" x 20" pre-drilled copper sheet and all necessary hardware for easy installation. Kits are available with or without an MDF mounting board. *Radio RF Ground Planes are intended for indoor use only and are not to be confused with ground planes or radial systems used for vertical antennas.*

- DXE-RGP-LC Copper Ground Plane Kit, 20" x 20" **\$217.99**
- DXE-RGP-LCB Copper Ground Plane Kit, 20" x 20" with MDF **\$235.99**
- DXE-RGP-MC Copper Ground Plane Kit, 16" x 16" **\$176.99**
- DXE-RGP-MCB Copper Ground Plane Kit, 16" x 16" with MDF **\$192.99**
- DXE-RGP-SC Copper Ground Plane Kit, 13" x 10" **\$114.99**
- DXE-RGP-SCB Copper Ground Plane Kit, 13" x 10" with MDF **\$124.99**



Weatherproofing Kits

Don't overlook the importance of weatherproofing your connectors. Moisture can cause corrosion, which leads to arcing, shorts and other significant RFI and electrical issues. The basic kit includes self-adhesive weatherproofing material and 3M Tartan 1710 vinyl UV-resistant electrical tape. The upgraded version uses professional grade Scotch Super 33+ tape, while our Ultimate version includes Super 88 electrical tape.

- DXE-WK-1 Basic Weatherproofing Kit, Tartan Tape **\$15.99**
- DXE-WK-2 Upgraded Weatherproofing Kit, Super 33+ Tape **\$20.99**
- DXE-WK-3 Ultimate Weatherproofing Kit, Super 88 Tape **\$23.99**
- DXE-WK-PRO Pro Kit, 5 Rolls Super 88 Tape, 3" x 6' Weatherproofing Material **\$97.99**



DXE-RGP-LA



Aluminum Radio RF Ground Plane Kits

For budget-minded hams, DX Engineering's Aluminum Radio RF Ground Plane Kits offer an effective solution for mitigating shack RFI issues but at a reduced cost. Kits are the same as the copper kits but with aluminum sheets.

- DXE-RGP-LA Aluminum Ground Plane Kit, 20" x 20" **\$72.99**
- DXE-RGP-LAB Aluminum Ground Plane Kit, 20" x 20" with MDF **\$102.99**
- DXE-RGP-MA Aluminum Ground Plane Kit, 16" x 16" **\$62.99**
- DXE-RGP-MAB Aluminum Ground Plane Kit, 16" x 16" with MDF **\$87.99**
- DXE-RGP-SA Aluminum Ground Plane Kit, 13" x 10" **\$51.99**
- DXE-RGP-SAB Aluminum Ground Plane Kit, 13" x 10" with MDF **\$71.99**



MFJ-4225MV



MFJ-4230MV

MightyLite Switching Power Supplies

Packing plenty of power into a compact package, MightyLite Power Supplies may be the perfect solution for Hams who are short on space but big on power demands. There are several options to choose from, so you can get the supply that meets your power requirements. The supplies are designed to accept input voltages ranging from 85 Vac to 250 Vac, and carry important safeguards like over-voltage and over-current limiting protection. Each supply uses a whisper-quiet internal fan to keep temperatures down. These supplies are a reliable and budget-friendly way to feed your shack with DC voltage.

Part Number	Features	Output	Connections	Amps at 13.8 Vdc	Price
MFJ-4125	Small, Lightweight	13.8 Vdc	5-Way Posts	22A Cont. 25A Peak	\$129.95
MFJ-4125P	Small, Lightweight	13.8 Vdc	5-Way Posts & Powerpole®	22A Cont. 25A Peak	\$139.95
MFJ-4225MV	Front-Panel Meters and Control	9-15 Vdc	5-Way Posts & Cig. Socket	22A Cont. 25A Peak	\$169.95
MFJ-4230MV	Front-Panel Meters and Control	4-16 Vdc	5-Way Posts	25A Cont. 30A Peak	\$149.95
MFJ-4245MV	Front-Panel Meters and Control	9-15 Vdc	5-Way Posts & Cig. Socket	40A Cont. 45A Peak	\$259.95



Flexible Copper Sheeting

Perfect for making Faraday shields, or for fabricating heat sinks, covers, ground busses, solder tabs and more. The 12" x 12" sheet is 0.022" thick.

- GCL-3215 Flexible Copper Sheeting **\$19.99**



Prices are subject to change without notice.



SXA-03436



SXA-03435

SEC Series Desktop Switching Power Supplies

Here are rock-solid power supplies that don't take up half of your shack. Compact and reliable, the SEC Series Desktop Switching Power Supplies are loaded with over-current, over-voltage and short-circuit protection. They're also well-filtered to produce clean, noise-free power. New from Samlex is the SEC-1235P-M model, which offers updated features, upgraded performance and ratings, and universal input of 100 to 240 VAC for international flexibility.

Rack Plates

These durable standard-width rack plates are a great way to get your SEC-series power supplies off your desk and into a rack. They have a black powdercoat finish and cutouts for bottom-mounted fans.

DXE Number	Samlex Number	Output (Cont.)	Output (Peak)	Price
120 Vac Input				
SXA-03051	SEC-1212	10A at 13.8 Vdc	14A at 13.8 Vdc	\$140.10
SXA-03061	SEC-1223	23A at 13.8 Vdc	25A at 13.8 Vdc	\$165.70
SXA-03064^	SEC-1223BBM	23A at 13.8 Vdc	25A at 13.8 Vdc	\$213.30
SXA-03431	SEC-1235	30A at 13.8 Vdc	35A at 13.8 Vdc	\$183.30
SXA-03435*	SEC-1235M	30A at 13.8 Vdc	35A at 13.8 Vdc	\$179.99
230 Vac Input				
SXA-03052	SEC-1212CE	10A at 13.8 Vdc	14A at 13.8 Vdc	\$155.10
SXA-03062	SEC-3062	23A at 13.8 Vdc	25A at 13.8 Vdc	\$179.80
120 and 230 Vac Inputs				
SXA-03436	SEC-1235P-M	30A at 13.8 Vdc	36A at 13.8 Vdc	\$205.99
Rackmount Plates and Power Supply Cable for SEC Series				
SXA-03104	Rackmount Plate for Single Supply			\$48.70
SXA-03105	Rackmount Plate for Dual Supplies			\$62.30
SXA-03294	SEC-PSP12"DC Pigtail with Powerpoles Terminations			\$24.90

* Includes Dual Meters ^ Includes Dual Meters and Battery Backup



DC/AC Pure Sine Wave Inverters

Radios, computers, A/V equipment and virtually any piece of precision electronic gear need the cleanest, most stable power source to function properly. Pure sine wave inverters are the best way to keep your transceiver and shack equipment functioning at their peak.



SXA-07370

DXE Number	Samlex Number	Watts (Cont.)	Watts (Surge)	Receptacles	Price
12 Vdc In/115 Vac Out Pure Sine Wave Inverters					
SXA-07370	SSW-350-12A	350	700	2 AC, 1 USB	\$132.60
SXA-07371	SSW-600-12A	600	1,200	2 AC, 1 USB	\$218.20
12 Vdc In/120 Vac Out Pure Sine Wave Inverters					
SXA-07223	PST-15S-12A	150	300	1 AC	\$195.50
SXA-07213	PST-300-12	300	500	2 AC	\$246.80
SXA-07215	PST-600-12	600	1,200	2 AC	\$329.60

SAM Series DC/AC

Modified Sine Wave Inverter

If you just want reliable DC power for your tools, lights or appliances, then you don't need a pure sine inverter. Save yourself some money and check out this modified DC/AC inverter from Samlex (SXA-07809). This SAM Series inverter converts 12- or 24-volt DC input voltage into reliable 120-volt AC. The unit boasts a maximum 800W of continuous power and 1,600W surge capability, plus two AC receptacles and one USB.



Both cost effective and powerful, SAM Series inverters feature a compact design, a load controlled cooling fan and an ETL safety listing. A USB charging port (5 Vdc, 500 mA) is included. **For details on more SAM Series inverters, ranging from 100 to 3,000 watts, enter "SAM Inverter" at DXEngineering.com.**

SXA-07809 DC/AC Modified Sine Wave Inverter, 800W..... **\$116.50**



ASR-SS-10



ASR-SS-25-AP



ASR-SS-25M-AP

SS Series Switching Power Supplies

If you need a power supply that doesn't eat up the space on your desk, Astron offers these low profile options. They deliver a steady 13.8 Vdc and are immune to RFI. These supplies include an EMI filter to resist RFI, even in the HF bands.

The "M" in the number denotes models that include front panel volt and amp meters. "AP" denotes models that feature Powerpoles and USB charging ports.

Part Number	Description	Amps Continuous/Peak	Price
ASR-SS-10	Power Supply	7A/10A at 13.8 Vdc	\$133.99
ASR-SS-12	Power Supply	10A/12A at 13.8 Vdc	\$147.99
ASR-SS-18	Power Supply	15A/18A at 13.8 Vdc	\$171.99
ASR-SS-25-AP	Power Supply	20A/25A at 13.8 Vdc	\$219.99
ASR-SS-25M-AP	Supply with Dual Meters	20A/25A at 13.8 Vdc	\$267.99
ASR-SS-30-AP	Power Supply	25A/30A at 13.8 Vdc	\$238.99
ASR-SS-30M-AP	Supply with Dual Meters	25A/30A at 13.8 Vdc	\$287.99
ASR-SS-50-AP	Power Supply	40A/50A at 13.8 Vdc	\$299.99
ASR-SS-50M-AP	Supply with Dual Meters	40A/50A at 13.8 Vdc	\$343.99



ASR-VS-35M-AP

VS Power Supplies

Astron's VS line of 13.8 Vdc power supplies have the same reliable performance of the RS line. These models also feature front-panel knobs, so you can easily adjust output from 2 to 15 Vdc. They include separate front-panel volt and amp meters.

Part Number	Description	Amps Continuous/Peak	Price
ASR-VS-12M-AP	Power Supply	9A/12A at 13.8 Vdc	\$237.99
ASR-VS-20ML	Supply, Cigarette Lighter Port	16A/20A at 13.8 Vdc	\$281.99
ASR-VS-35M-AP	Power Supply	25A/35A at 13.8 Vdc	\$399.99
ASR-VS-50M-AP	Power Supply	37A/50A at 13.8 Vdc	\$566.99
ASR-VS-70M-AP	Power Supply	57A/70A at 13.8 Vdc	\$644.99

VLS Series Power Supplies

With an adjustable output voltage from 5 to 32 volts, these power supplies can provide DC power to a wide range of shack gear. They feature front-panel adjustable output controls, making them great bench "test" power supplies. These supplies are also great solutions if you have unique voltage requirements.

Part Number	Description	Amps Continuous/Peak	Price
ASR-VLS-10M	Supply with Dual Meters	8A/10A at 28 Vdc	\$279.99
ASR-VLS-25M	Supply with Dual Meters	18A/25A at 28 Vdc	\$551.99
ASR-VLS-35M	Supply with Dual Meters	27A/35A at 28 Vdc	\$627.99

LS Power Supplies

Delivering an adjustable 22 to 32 volts of regulated DC power, these Astron linear power supplies feature over-voltage protection, low-ripple and a heavy-duty heat sink. Each power supply incorporates fold-back current limiting to protect it from excessive current and accidental shorts.

Part Number	Description	Amps Continuous/Peak	Price
ASR-LS-3A	Power Supply	3A/4A at 28 Vdc	\$131.99
ASR-LS-10A	Power Supply	8A/10A at 28 Vdc	\$214.99
ASR-LS-18A	Power Supply	12A/18A at 28 Vdc	\$348.99
ASR-LS-25A	Power Supply	18A/25A at 28 Vdc	\$484.99
ASR-LS-35A	Power Supply	27A/35A at 28 Vdc	\$562.99
ASR-LS-35M	Supply with Dual Meters	27A/35A at 28 Vdc	\$612.99

Our catalog is only the beginning! See thousands of products at DXEngineering.com



RS Power Supplies

These rugged, reliable units are electronically regulated to maintain low ripple at low-line input voltage. They are internally adjustable from 11 to 15 Vdc and include fold-back current limiting to protect your power supply from excessive current and continuous shorted output. Depending on the model, you get features like crowbar over-voltage protection, heavy-duty heat sinks and chassis-mounted fuses for extra protection against overheating and shorting. "BB" in the part number denotes models that have an integrated battery backup and trickle charger. An "M" in the part number indicates that the units have either dual or single volt/amp meters, and a "AP" in the part number indicates the unit also has Powerpole® connectors on the front panel.



ASR-RS-35M-AP

Part Number	Description	Amps Continuous/Peak	Price
ASR-RS-4A	Power Supply	3A/4A at 13.8 Vdc	\$95.99
ASR-RS-4L	Supply, Cigarette Port	3A/4A at 13.8 Vdc	\$99.99
ASR-RS-5A	Power Supply	4A/5A at 13.8 Vdc	\$101.99
ASR-RS-7A	Power Supply	5A/7A at 13.8 Vdc	\$125.99
ASR-RS-12A	Power Supply	9A/12A at 13.8 Vdc	\$168.99
ASR-RS-12M	Supply with Switchable Meter	9A/12A at 13.8 Vdc	\$194.99
ASR-RS-12A-BB	Supply with Battery Backup	9A/12A at 13.8 Vdc	\$190.99
ASR-RS-12M-BB	Supply with Meter and Backup	9A/12A at 13.8 Vdc	\$220.99
ASR-RS-20A	Power Supply	16A/20A at 13.8 Vdc	\$207.99
ASR-RS-20M-AP	Supply with Dual Meters	16A/20A at 13.8 Vdc	\$257.99
ASR-RS-20A-BB	Supply with Battery Backup	16A/20A at 13.8 Vdc	\$239.99
ASR-RS-20M-BB	Supply with Meters and Backup	16A/20A at 13.8 Vdc	\$287.99
ASR-RS-35A-AP	Power Supply	25A/35A at 13.8 Vdc	\$322.99
ASR-RS-35M-AP	Supply with Dual Meters	25A/35A at 13.8 Vdc	\$367.99
ASR-RS-50A	Power Supply	37A/50A at 13.8 Vdc	\$484.99
ASR-RS-50M-AP	Supply with Dual Meters	37A/50A at 13.8 Vdc	\$536.99
ASR-RS-70A	Power Supply	57A/70A at 13.8 Vdc	\$556.99
ASR-RS-70M-AP	Supply with Dual Meters	57A/70A at 13.8 Vdc	\$627.99



Rack Mounted Linear Power Supplies

Get consistent, reliable power using these rack mounted linear power supplies. These adjustable, solid state supplies are electronically regulated to offer less than 5mV peak to peak ripple. They incorporate fold-back current limiting and a heavy-duty heat sink to ensure years of solid power delivery. Find full details at DXEngineering.com.



ASR-RM-50M

Part Number	Description	Amps Continuous/Peak	Price
Rack Mounted Power Supplies with 11 to 15 Vdc Adjustable Output			
ASR-RM-35A	Power Supply	25A/35A at 13.8 Vdc	\$478.99
ASR-RM-35A-BB	Power Supply, Battery Backup	25A/35A at 13.8 Vdc	\$519.99
ASR-RM-35M	Power Supply, Dual Meters	25A/35A at 13.8 Vdc	\$506.99
ASR-RM-35M-BB	Supply, Dual Meters, Battery Backup	25A/35A at 13.8 Vdc	\$560.99
ASR-RM-50M	Power Supply, Dual Meters	37A/50A at 13.8 Vdc	\$590.99
ASR-RM-50M-BB	Supply, Dual Meters, Battery Backup	37A/50A at 13.8 Vdc	\$636.99
ASR-RM-60M	Power Supply, Dual Meters	50A/55A at 13.8 Vdc	\$777.99
ASR-RM-60M-BB	Supply, Dual Meters, Battery Backup	50A/55A at 13.8 Vdc	\$874.99



YSU-FP-1030A

Power Supplies

Designed to work with Yaesu and other radios, these 120VAC input power supplies deliver a clean and steady 13.8 Vdc. An excellent choice for your base station, the switching power supply is fan cooled and supplies 23A (peak)/20A (cont.).

The FP-1030A offers 25A (peak)/22A (cont.). It's a fan-cooled, linear power supply with a pair of front panel volt and amp meters. The supply also features two pairs of terminals, a set of binding posts and a front panel cigarette lighter socket, making it a good bench supply for testing and diagnostic work.



YSU-FP-1023A	Switching Power Supply	\$159.99
YSU-FP-1030A	Linear Power Supply	\$269.99

We stock many more items than we can show. See them all at DXEngineering.com!



Switching Mode Power Supplies

Alinco adjustable power supplies perfectly complement its radios, yet they're also excellent bench supplies for gear that needs a stable, clean DC power source. They feature a selectable volt/amp meter and a handy noise offset knob to let you move the switching noise to another frequency. These supplies also incorporate short circuit and current limiting protection.

The DM-330MVT model has a programmable pre-set voltage function that lets you store the most frequently used voltage in the memory for quick access, a cigar-plug socket (Max 10A), a set of Max current terminals, and two sets of snap-in terminals (Max 5A) to optimize operational flexibility. The DM-30TR comes with two pairs of Anderson Powerpole connectors on the front panel for extra versatility. The DM-530T is Alinco's largest digital power supply, featuring a highly visible and accurate digital Volt/Amp meter that allows real-time monitoring of the output current, along with a durable cooling fan that keeps the unit running continuously under heavy loads. All models accept 120 Vac input voltage.



ALO-DM-30TR



ALO-DM-330MVT



ALO-DM-530T

New!

Part Number	Output	Peak Current	Display	Connections	Price
ALO-DM-30TR	9-15 Vdc	30A	Digital	Binding Posts, Powerpoles	\$145.95
ALO-DM-330MVT	5-15 Vdc	32A	Analog	Binding Posts, Cig. Lighter, Terminals	\$199.95
ALO-DM-530T	5-15 Vdc	30A	Digital	Binding Posts, Powerpoles, USB Ports	\$239.95



AME-SPS-75MV 75 Amp Switching Power Supply

This power supply provides 75 amps continuous output current—ideal for use with Ameritron's ALS-500M 500 watt solid state amplifier. It has less than 100 mV peak-to-peak ripple under full load. Load regulation is better than 1.5% under full load. Other features include reverse-polarity protection, brownout input protection, over-current/over-temperature protection and a thermally-controlled quiet fan. Output voltage is variable with metering for both voltage and current.

- Input: 108-132 Vac, 50/60 Hz
- Current Draw: 11 Amps

AME-SPS-75MV 75 Amp Switching Power Supply..... **\$399.95**



Heavy-Duty 75 Amp Switching Power Supply

With a whopping 70A continuous/75A peak, this unit can power your mobile HF, VHF/UHF rigs or high-current accessories without breaking a sweat. Voltage output is adjustable from 4 to 16 Vdc using the front panel knob. Dual meters let you monitor voltage and current, and there are indicator LEDs to show power and fault status.

This power supply has short circuit, overload and over-temperature protection. You can hook up your equipment with binding posts, Anderson Powerpoles®, quick connects and a handy cigarette lighter socket. It uses a whisper-quiet cooling fan.

MFJ-4275MV Heavy-Duty 75 Amp Switching Power Supply **\$379.95**



DC Switching Power Supply

Kenwood has answered your call for a versatile supply that delivers clean, noise-free power. The KPS-15 model offers over-voltage, over-current, and over-temperature protection.

Weighing only 3.3 pounds, this compact supply (7.2" W x 2.2" H x 8.7" D) will power virtually any radio that needs 13.8 Vdc at 23A (cont.)/25A (peak). The input voltage is easily reset internally from 120VAC to 240VAC. Includes standard rear panel AC connector IEC 320-C13 three conductor and DC screw-down terminals.

KWD-KPS-15 Power Supply, 13.8 Vdc, 25A Peak, Convection Cooled... **\$179.99**



KWD-KPS-15



PPA-PP45-10PK

Powerpoles®

Powerpoles are the industry standard connectors for low voltage DC power applications. You'll find Powerpoles spec'd for a variety of government projects and they're in commercial broadcast stations all over the planet. They are the standard for ARES® and RACES units. The Powerpoles listed below safely handle 15-45 amps and are compatible with 20 to 10 AWG zip cord. In standard form, Powerpoles come disassembled, but there are also ultrasonically welded preassembled pairs that simplify installation.

DX Engineering carries virtually any Powerpole variant you'll need, along with accessories, zip cord, and the proper assembly tools.

Part Number	Description	Qty	Price
DXE-POWERBOX-C1	Connectors, Contacts, Clips, and Tool in Special Storage Case	1	\$138.39
PPA-1X2RK-2PK	Standard Housings with Vertical PCB Contacts, 45A, Red/Black	2	\$7.99
PPA-1327G7-10PK	Standard Connectors, White	10	\$10.90
PPA-1327G8-10PK	Standard Connectors, Blue	10	\$10.99
PPA-1327G16-10PK	Standard Connectors, Yellow	10	\$10.99
PPA-1327G5-10PK	Standard Connectors, Green	10	\$10.99
PPA-1327-10PK	Standard Connectors, Red	10	\$10.99
PPA-1327G6-10PK	Standard Connectors, Black	10	\$10.99
PPA-1399G1-10PK	Spacers, PP15/45, Red, Short with Hole	10	\$5.99
PPA-1399G2-10PK	Spacers, PP15/45, Red, Long	10	\$5.99
PPA-1399G6-10PK	Spacers, PP15/45, Red, Short	10	\$5.99
PPA-1399G9-10PK	Mounting Wings, PP15/45	10	\$5.99
PPA-STDHSG-11PK	Standard Connectors, Assorted Colors	11	\$6.99
PPA-PP15-10PK	Pair, 10 Red + 10 Black, for ≤ 16 AWG Wire	20	\$19.99
PPA-PP45-10PK	Pair, 10 Red + 10 Black, for 10-14 AWG Wire	20	\$29.99
PPA-PP45-25PK	Pair, 25 Red + 25 Black, for 10-14 AWG Wire	50	\$69.99
PPA-PP45-50PK	Pair, 50 Red + 50 Black, for 10-14 AWG Wire	100	\$125.99
PPA-PP30-10PK	Pair, 10 Red + 10 Black, for 12-16 AWG Wire	20	\$25.99
PPA-PP30-25PK	Pair, 25 Red + 25 Black, for 12-16 AWG Wire	50	\$49.99
PPA-PP30-50PK	Pair, 50 Red + 50 Black, for 12-16 AWG Wire	100	\$89.99
PPA-PP30-100PK	Pair, 100 Red + 100 Black, for 12-16 AWG Wire	200	\$175.99
PPA-WP30-10PK	Preassembled Welded Housing Pair, 10, for 12-16 AWG Wire	20	\$18.49
PPA-WP30-40PK	Preassembled Welded Housing Pair, 40, for 12-16 AWG Wire	80	\$51.99
PPA-ASMPP30-8PK	Powerpole Assembly, 2 Wire Red/Black, Single Row	8	\$9.49
PPA-261G1-25PK	Contact Terminals Only, 30A, for 12-16 AWG Wire	25	\$21.99
PPA-261G2-25PK	Contact Terminals Only, 45A, for 10-14 AWG Wire	25	\$22.99
PPA-261G2-50PK	Contact Terminals Only, 45A, for 10-14 AWG Wire	50	\$43.99
PPA-1331-25PK	Contact Terminals Only, 30A, for 12-16 AWG Wire	25	\$9.50
PPA-1331-50PK	Contact Terminals Only, 30A, for 12-16 AWG Wire	50	\$19.99
PPA-1332-25PK	Contact Terminals Only, 15A, for 16-20 AWG Wire	25	\$9.99
PPA-1332-50PK	Contact Terminals Only, 15A, for 16-20 AWG Wire	50	\$19.99
PPA-200G1L-25PK	Contact Terminals, 45A, for 10-14 AWG High Stranding Wire	25	\$27.99
PPA-PCLIP-25PK	Retention Clips	25	\$23.99

Magnetic Tool Trays

These handy magnetic tool trays from Summit Racing are perfect for keeping small metal parts, connectors, adapters, fasteners, and tools in place so they won't come up missing during your projects in and out of the shack. Made of polished stainless steel, the round 910060 tray (4.25" diameter, 1.25" tall) and the rectangular 910061 model (5.375" x 9.375", 1.25" tall) stick to most metal surfaces and have rubber feet to prevent scuffing and scratching. A smart idea for everything from antenna building to grounding jobs.



- SUM-910060 Magnetic Parts/Tool Tray, Round.....\$3.99
- SUM-910061 Magnetic Parts/Tool Tray, Rectangular.....\$10.99

50A Switching Power Supply

This dependable, well-built switch mode AC to DC power supply comes with variable output voltage and is suitable for use with all electronic and telecommunication devices. It comes with illuminated voltmeter and ammeter, and a knob for adjusting output voltage. The power supply (50A continuous/peak load) can be set for a fixed output voltage of 13.5 VDC or adjusted from 9 to 15 VDC via front panel slide switch. Cooling is provided by a large rear panel fan. Rear panel DC connectors are five-way binding posts with removable red and black thumbscrews for stripped wire, ring terminals, and banana plugs. Input 100-120VAC, attached three-prong cord. The unit weighs 6.4 lbs. and measures 7.2" W x 4.4" H x 11.2" D.



New!

- RMY-SPS1050S 50A Switching Power Supply \$305.99

RigExpert

Shackmaster™ Power 500 Power Supply

This space-saving and sturdy desktop 36A/13.8V power supply boasts 500W of continuous power; a mains input range of 80-264 VDC and 47-63 Hz; customizable touchscreen panel for on-off, power, voltage, amperage, and temperature readouts; a display that visually rotates to support horizontal or vertical orientation; an Intelligent Protection System that provides safeguards against overvoltage, overcurrent, and short circuits; low EMI and acoustic noise (21 dB operation); and multiple connectivity options (full power 5V USB A and USB B charging ports, 13.8V front and rear panel 45A rated Powerpoles, and 30A rated rear panel binding posts); plus real-time remote control capability, all housed in a sleek design that will look great in your shack. Plus, the Power 500 goes through four phases of quality control checks before arriving at your station—your guarantee that you've made a solid choice. Enter "POWER500" at DXEngineering.com for more details.



New!

- REU-POWER500 Shackmaster 500W Power Supply..... \$389.99

GZV4000 Switching Mode Power Supply



The compact and lightweight GZV4000 provides a variable voltage output from 5 to 15 Vdc at up to 40 amps in continuous operation.



DMN-GZV4000

This versatile power supply looks great and offers you rock-solid performance. The attractive front panel includes a selectable meter with post, snap-on and cigarette lighter outputs. The voltage control knob has a center 13.5 Vdc detent for precise adjustability. A built-in 8 watt speaker makes this power supply a versatile addition to your shack's setup. Includes overload and over-temperature protections, plus insensitivity to RFI.

- DMN-GZV4000 Switching Mode Power Supply, 40A.....\$199.99

DX ENGINEERING

Ultra-Grip 2 Crimp Connector Hand Tool for Powerpoles®



Installing Powerpole® connectors? This tool ensures a professional-quality crimp on your coaxial cable. The crimp tool comes with dies for 15, 30 and 45 amp Anderson Powerpole connectors. Additional dies and a case are available separately.

- DXE-UT-CRMP2-PWR Ultra-Grip 2 Crimp Connector Tool for Powerpoles \$67.98

Anderson Power Products®

Powerpole® Insertion or Extraction Tool

Use this specialized tool to properly install the metal contacts into your Powerpole connectors. It's compatible with PP15 to PP45 type connectors.

- PPA-111038G2 Powerpole Insertion or Extraction Tool \$9.99



Hum's the Word.

A proper ground system is absolutely crucial in helping to squash out electrical noise in your Ham station. Don't just address grounding at your tower or antenna. Make sure you've got your shack gear all connected to a single point ground too. Check out page 105 for Grounding & Lightning Protection.

DXEngineering.com is loaded with detailed photos, specs, videos, and more!

4-Way and Fuser-6 DC Distribution Boxes

SOTABeams' lightweight and portable 4-Way DC Distribution Boxes provide a convenient way to power three devices using Anderson PowerPoles®. Simply attach your DC input cable to one set of connectors to power the other three sets. A fused input cable is recommended. With one input and 5 outputs, Fuser-6 DC Distribution Boxes make light work of connecting five accessories to your power source. All connectors are individually fused, and boards use genuine Anderson PCB contacts for lower contact resistance and improved reliability. Both models have a 25 amp continuous rating (total) and a 30 amp momentary surge rating. Choose from preassembled/ tested models or easy-build kits. **For more features and benefits, enter "SBM Boxes" at DXEngineering.com.**



- SBM-4-WAY-BLT 4-Way PowerPoles Connector Box, Preassembled..... **\$34.99**
- SBM-4-WAY-KIT 4-Way PowerPoles Connector Box, Kit..... **\$26.99**
- SBM-FUSER-6-BLT Fuser-6 PowerPoles Connector Box, Preassembled..... **\$72.99**
- SBM-FUSER-6-KIT Fuser-6 PowerPoles Connector Box, Kit..... **\$48.99**

PARADAN radio

Power Strip 4 Plus

Looking for a reliable 40 amp metered power strip to tidy up your station or toss in your Go-Kit? Paradan's Power Strip 4 Plus makes a great choice. Housed in a sturdy metal case, the rugged unit permits easy connections to the four Anderson Powerpole outputs. Its bright LED accurately displays both the DC voltage and the total current in amperes. Anderson locking clips may be used to secure the connections. This RF-filtered strip comes with 5 Anderson Powerpole pairs.



- PDN-PS4-PLUS 40 Amp Metered Power Strip 4 Plus..... **\$110.00**

PARADAN radio

Power Strip 6

Keep your shack tidy and your Go-Kit well-equipped with the Paradan Radio Power Strip 6 metered DC distribution panel. Housed in a sturdy metal case, the RF filtered strip permits easy connections of power cables to the six bottom-mount Anderson Powerpole outputs. The input is fused to 40A. Bright 3-digit, 7-segment LEDs accurately display the DC voltage and total current. Seven pairs of Powerpoles and 40A ATC fuses are included. Any rating ATC fuses may be used as needed.



- PDN-PS6 40 Amp Power Strip..... **\$130.00**

200 Amp Inline DC Power Analyzer and Watt Meter Kit

This low-power-consumption device provides high-precision reading of voltage, current, watts, amp/ hours, and watt/ hours. Capable of measurements of 4.8-60 VDC and up to 200 amps, the meter is powered by the source voltage it measures and will display accumulated amp/hour and watt/hour readings until the meter is shut down or restarted. By connecting a separate battery or power source to the optional Auxiliary Power Connector, the meter will precisely measure the complete range of 0-60 VDC. The 16x2 backlit LCD screen is easy to read, even in direct sunlight. Kit comes with Anderson Powerpole connectors. Also available without connectors.



- DMV-DC-VAWM-200P Inline DC Power Analyzer/Watt Meter Kit..... **\$44.98**

WEST MOUNTAIN RADIO



WMT-58315-1043



WMT-58307-1037



WMT-58307-1035

RIGrunner DC Outlet Panels

Got a pile of spaghetti where your DC power cables should be? These RIGrunner Outlet Panels will clean up your shack, while giving you some advanced features in the process. Each outlet is fused for protection and ensures you have reliable power distribution for your gear. Most provide 40 amps of maximum output current and include Powerpole® connectors and fuses. "U" models have USB ports, handy for charging your smartphone. If you're installing one in a vehicle, check out the 4010S+ models, which feature programmable voltage thresholds and automatic on/off parameters, plus a built-in PWRguard.

Part Number	Description	Voltage Alarm	Power Cables	Powerpole® Connections	Price
WMT-58301-1028	RIGrunner 8012, 80A Input	Yes	8 AWG, 6'	12	\$189.95
WMT-58303-1601	RIGrunner 4010S+, PWRguard	Yes	Sold Separately	10	\$179.95
WMT-58303-1609	RIGrunner 4010S+, PWRguard	Yes	10 AWG, 6'	10	\$199.95
WMT-58307-1034	RIGrunner 4008	Yes	10 AWG, 6'	8	\$124.95
WMT-58307-1035	RIGrunner 4008	No	Sold Separately	8	\$104.95
WMT-58307-1036	RIGrunner 4008H, Side Connectors	No	10 AWG, 6'	8	\$119.95
WMT-58307-1037	RIGrunner 4008H, Side Connectors	No	Sold Separately	8	\$99.95
WMT-58307-1124	RIGrunner 4008, -48 Vdc Negative	Yes	Sold Separately	8	\$174.95
WMT-58307-1126	RIGrunner 4008, -48 Vdc Positive	Yes	Sold Separately	8	\$134.95
WMT-58307-1125	RIGrunner 4008, -24 Vdc Positive	Yes	Sold Separately	8	\$134.95
WMT-58312-1038	RIGrunner 4005	No	10 AWG, 6'	5	\$94.99
WMT-58312-1039	RIGrunner 4005	No	Sold Separately	5	\$74.95
WMT-58312-1040	RIGrunner 4005, Side Connectors	No	10 AWG, 6'	5	\$89.95
WMT-58312-1041	RIGrunner 4005, Side Connectors	No	Sold Separately	5	\$74.95
WMT-58315-1042	RIGrunner 4004U, 2 USB Charge Ports	No	10 AWG, 6'	4	\$104.95
WMT-58315-1043	RIGrunner 4004U, 2 USB Charge Ports	No	Sold Separately	4	\$89.95



MFJ-1117



MFJ-1118

Multiple Outlet Panels

Answering your call for reliable and safe power distribution, these high-current outlet strips let you connect multiple pieces of gear without cluttering up your shack. They use heavy-duty fused outputs to protect your equipment and are housed in an easy-to-mount aluminum chassis. Connection to your ground system is as simple as turning the wing nut on the chassis mounted lug. Fuses and 6 feet of stranded 8-gauge power cord are included.



MFJ-1124

Part Number	Description	Max. Current	High Current Connections	Low Current Connections	Price
MFJ-1112	DC Power Outlet Strip	15A	None	6 Binding Posts	\$79.95
MFJ-1116	Switched Outlet Strip with Meter	15A	None	8 Binding Posts	\$99.95
MFJ-1117	DC Power Outlet Strip	35A	2 Binding Posts	2 Binding Posts	\$94.95
MFJ-1118	Switched Outlet Strip with Meter	35A	2 Binding Posts	6 Binding Posts	\$119.95
MFJ-1124	DC Power Outlet Strip	40A	2 Powerpole®	2 Powerpole®	\$109.95
MFJ-1126	Switched Outlet Strip with Meter	40A	1 Powerpole®	5 Powerpole®	\$129.95
MFJ-1128	Switched Outlet Strip with Meter	40A	3 Powerpole®	9 Powerpole®	\$159.95
MFJ-1129	Switched Outlet Strip with Meter	40A	2 Powerpole® 1 Binding Post	5 Powerpole® 2 Binding Posts	\$169.95

DX Engineering carries equipment from more than 160 top manufacturers!



Battery Backup Module

Add battery backup to your shack. Just connect this unit between your power supply and a wet or SLA standby battery, and it acts as a float charger to keep the battery ready. If your AC power fails, it will automatically switch to the battery in an instant. Fuses protect the circuit during battery charge/discharge and a front LED indicates the charging status. Maximum battery load is 30A and the unit limits charging at 3.6A. The module works with 12- and 24-volt systems.

ASR-BB-30M Battery Backup Module.....\$80.99



Battery Backup Module

Connect this module to your power supply and battery to make a battery backup system. When your AC power fails, the unit will instantly switch to your battery. When the AC power is restored, it switches back to charging. The module works with voltages from below 12 Vdc, up to 28 Vdc and can handle a maximum output current of 100 amps. This float-type battery charger can be an essential backbone for your shack or EMCOMM setup.

SXA-08081 BMM-12100 Battery Backup Module..... \$183.80

Super Battery Booster



Your mobile rig may not always get a stable 13.8 Vdc from your vehicle's battery. To combat the fluctuations in power and keep your radio operating at its fullest potential, install this MFJ Battery Booster. It ensures a steady stream of 13.8 Vdc and can be tailored to specific voltage limits, protecting your battery from over-discharge. An internal 30 amp input fuse prevents excess output and this unit has over-voltage protection. Input voltage and output voltage are adjustable.

MFJ-4416C Super Battery Booster..... \$249.95



Bias-Tee Power Injector



Is your antenna array far from your shack? Here's a great way to ensure you can still get DC power down your coax to operate your remote tuners, rotor, etc. It works on frequencies from 1 to 60 MHz and has a switch to turn your remote equipment on and off. This unit requires a standard 2.1mm, 1A (max.) power adapter.

MFJ-4117 Bias-Tee Power Injector..... \$49.95



AC Line RFI Filter

Squash that annoying RF hash coming from your AC power line. This filter significantly reduces the noise, transients and surges coming from your shack and the environment. This unit also features nanosecond-fast over-voltage protection. It is made for 120 Vac and has four receptacles.

MFJ-1164B AC Line RFI Filter..... \$129.95



Temporary Power Node

Perfect for Field Day, EMCOMM, temporary installations or when you just need an extra outlet, this node gives you four pairs of paralleled Anderson Powerpole® connectors. Total rated current is 40A at 12 Vdc, just make sure your DC power wire gauge matches your power demands. Retaining clips are included.

WMT-58519-1067 Temporary Power Node..... \$19.95



Deltran Battery Tender Jr. Chargers and More



Charging power when you need it! Deltran Battery Tender Junior chargers are lightweight, and their compact size makes them great for those hard-to-fit spots. They feature a trickle charger with a brain to ensure that batteries are maintained after charging. The units are available in 8V and 12 V models, as well as a variety of amperage ratings. Additional benefits include a solid state two-color LED that indicates stage of charger, spark-proof reverse polarity protection, 12' output cord, and five-year warranty. Enter "Deltran" at DXEngineering.com for the full lineup of products, including Deltran's four bank battery charger, two bank battery tender charging station, waterproof charger, dual-port USB charger, and quick-disconnect USB charger.



DC Gate 40 Plus Battery Backup System

This 13.8 volt battery backup system is perfect for powering your station, Go-Kit, or RV. It can output up to 40 amps from either the power supply or the battery. In case of lost AC power, the diode gate switches instantaneously from the power supply to the battery. When the power returns, the built-in 2-amp rapid charger restores the charge and keeps the battery fresh. Solidly made on a heatsink, the unit comes with three Powerpole pairs.

PDN-DCGATE40PLUS DC Gate 40 Plus Battery Backup System \$120.00



Epic PWRgate Battery Backup System

This third-generation power gate product from West Mountain Radio delivers advanced technology and low power loss with maximum flexibility to charge modern batteries. It features:

- 12 volt backup power system rated at 40 amperes continuous from either a power supply or battery
- Connected equipment instantly switches to battery during a power blackout or power supply failure
- Forward voltage drop of only 0.05 volts
- USB port access to monitor system or to change charge parameters
- Supports smart charging of either lead acid or Li-Ion battery charging up to 10A
- Direct solar panel input for battery charging (all chemistries)

Enter "West Epic" at DXEngineering.com for more details.

WMT-58404-1795 Epic PWRgate Battery Backup System \$189.95



PWRcheck+ DC Power Analyzer

This highly accurate and versatile device handles eight display modes including voltage, current flow in either direction, wattage and amp-hours. The PWRcheck+ measures 0V to 60V (less than 8V requires USB power to PWRcheck+) 40A continuous load. Its vibrant LCD color touchscreen displays data in digital, analog and bar graph formats. Downloadable software lets you easily program every aspect of PWRcheck+ operation, including data logging rate, display formats, and alarm conditions. It also enables you to display current, voltage, wattage and amp-hours in real time. * PWRcheck+ requires a minimum 50mA load to measure voltages below 4.5V.

WMT-58430-1564 DC Power Analyzer..... \$184.95



Super PWRgate PG40S

The Super PWRgate maintains a steady stream of up to 40A continuous from your power supply or battery and will instantly switch to battery backup if you lose power—you won't even notice the switchover. It also has a built-in battery charger to ensure that your battery is ready when you need it.

WMT-58403-1046 Super PWRgate PG40S \$139.95



PWRguard Plus

If your power supply is rapidly changing, the PWRguard Plus can sense it and shut the system down, preventing expensive damage to your equipment. You can set the voltage trip threshold and the PWRguard has in-rush current protection as an extra precaution against damage. It's rated for a maximum of 40 amps (peak) and indicator LEDs let you know it is working.

WMT-58402-1045 PWRguard Plus \$114.95



ISOpwr

Turn your vehicle into a battery charger. The ISOpwr lets you connect an additional battery to your vehicle's battery to charge both of them when the alternator is running. When the alternator stops, this unit isolates your main battery to prevent it from draining. It's an essential tool for power-hungry mobile installations like an ARES® or RACES command station, or contest mobile rover.

WMT-58401-1044 ISOpwr..... \$119.95



Most in-stock parts ship throughout the contiguous US in just 1-2 days!

PARADAN radio

New!

Mobile LiFePO4 Battery Charger

This device lets you use any cigarette lighter/accessory power socket in your car, truck, or boat to charge 12V Lithium Ferrous Phosphate (LiFePO4) batteries. The vehicle's 12V system is converted into 14.2V while limiting the current to 3 amps. The unit's bright LED meter displays the battery's voltage and charging amperage. Two output wires (one with Powerpole plug and the other with DC barrel power plug) are included. When fully charged, the current reads close to zero and the battery's float voltage is then displayed. Housed in a sturdy aluminum case, the charger lets you power equipment using the Powerpole plug while the battery is being charged.



PDN-BAT-CHARGER Mobile LiFePO4 Battery Charger..... **\$100.00**

CBA V—Computerized Battery Analyzer



From the innovators at West Mountain Radio comes this versatile device designed for advanced and highly accurate scientific battery performance assessments, offering significant upgrades over past CBA models. Execute fast tests under real-world load conditions, up to 150 watts or 40 amps maximum; high-voltage testing at up to 55 V; power profile tests (increase current at user's rate to see how voltage/power responds), useful for testing maximum power output of a power supply or solar cell; true constant current battery capacity test with results graphically displayed; multiple discharge tests that can use watts as a parameter; and much more. Each individually calibrated unit includes an on-board computer that performs accurate measurements with 12-bit effective resolution, remote voltage sensing for greater accuracy, an array of built-in safety features for battery protection, and free software for valuable data analysis.



WMT-58250-1852 Computerized Battery Analyzer..... **\$189.95**

DX ENGINEERING

Power Wire, 2 Conductor Zip Cord

Zip Cord is two-conductor cord which is typically used for low voltage DC power wiring circuits. The red and black colors make it simple to identify polarity for DC applications.



DXE-PW-8	Power Wire, 8-Gauge	per foot	\$1.49
DXE-PW-10	Power Wire, 10-Gauge	per foot	\$2.12
DXE-PW-12	Power Wire, 12-Gauge	per foot	\$1.82
DXE-PW-14	Power Wire, 14-Gauge	per foot	\$0.89
DXE-PW-16	Power Wire, 16-Gauge	per foot	\$0.55
DXE-PW-18	Power Wire, 18-Gauge	per foot	\$0.47

ECG

Surge Protectors

You've spent a lot of time and money to build the perfect station. Don't take chances on a box-store AC power strip. These options from ECG are tailor made for Amateur stations.

The EMF-63A has six outlets, each one surge protected from transient spikes up to 15 amps. It has full three-mode protection: hot to neutral, hot to ground and neutral to ground. It also suppresses up to 20 dB of EMI/RFI noise from 150 kHz to 30 MHz. The EMF-67 boasts seven outlets, protected to 15 amps, along with 20 dB of EMI/RFI noise suppression.

Perfect for vacationing or for ordinary household power needs, the EMF-3 packs two 15A surge-protected AC outlets, plus a pair of 5V/2A USB ports for your phone or tablet. Stuff one in your road bag; you'll use it sooner than you think.

ECG-EMF-63A	6-Outlet Surge Protector	\$28.99
ECG-EMF-67	7-Outlet Surge Protector	\$19.99
ECG-EMF-3	USB Surge Protector	\$18.99



ECG-EMF-67



ECG-EMF-63A

ECG-EMF-3



Electrical Fuses

DX Engineering carries a nice selection of high-quality Summit Racing Electrical Fuses from 5 to 60 amps. They're available in regular (ATO/ATC) or Maxi (APX) styles, individually or in sets of 5.

SUM-900287	40 Amp, Maxi, Each	\$4.99
SUM-900288	60 Amp, Maxi, Each	\$4.99
SUM-900280	5 Amp, ATO/ATC, Set of 5	\$3.99
SUM-900281	10 Amp, ATO/ATC, Set of 5	\$4.99
SUM-900282	15 Amp, ATO/ATC, Set of 5	\$4.99
SUM-900283	20 Amp, ATO/ATC, Set of 5	\$4.99
SUM-900284	30 Amp, ATO/ATC, Set of 5	\$4.99



NTE ELECTRONICS, INC.

Assorted Color Wire Kits

Here's an easy way to keep your workbench fully stocked! Available in either 24 AWG solid or 24 AWG stranded versions, these kits of PVC-insulated wire are ideal for the hobbyist, repair tech or experimenter. You receive 60 meters (197') of pre-cut and pre-tinned copper hook-up wires in lengths of 10m (32.8'), Black and Red; and 5m (16.4'), White, Blue, Brown, Green, Yellow, Orange, Gray and Violet.



NTE-WK-1	24 AWG Solid Wire, 10 Colors	\$26.99
NTE-WK-2	24 AWG Stranded Wire, 10 Colors	\$22.99

Pre-Loaded Wire Assortment Kits

These Pre-Loaded Wire Assortment Kits come packaged in a convenient, side feed box that will keep your hookup wire neat, clean, and ready for your next amateur radio project. Each box contains six 25' spools of 300V wire colored in white, black, blue, red, green, and yellow. Kits come with either traditional UL1007 PVC insulated or soft silicone rubber insulated wire. Choose between 18 or 22 AWG stranded, tinned copper wire.



NTE-WAK-PVC18	Wire Assortment Kit, PVC Insulated, 18 AWG	\$43.99
NTE-WAK-PVC22	Wire Assortment Kit, PVC Insulated, 22 AWG	\$22.99
NTE-WAK-SIL18	Wire Assortment Kit, Silicone Insulated, 18 AWG	\$48.99
NTE-WAK-SIL22	Wire Assortment Kit, Silicone Insulated, 22 AWG	\$28.99



Jumper Test Leads

These 120" long, retractable jumper test leads come with alligator clip terminals to ensure secure circuit testing. Featuring 18-gauge copper wire, the three color-coded leads can be used for bypassing lengths of wire and simulating switches. The insulated clips provide sound connections for simpler testing. Allows for a maximum of 10 amps unwound or 6 amps wound.



SUM-900044 Retractable Jumper Test Leads **\$19.99**

Plunger Clip Test Lead Kit

This useful kit comes with ten 16" jumper test leads (two each in black, red, yellow, green, and white). Featuring 22-gauge copper, these well-built leads are handy to have around the shack—whether you're working on PCBs or point-to-point wiring.



NTE-72-110 Test Lead Kit..... **\$21.99**

NTE ELECTRONICS, INC.

Barrier Strips

As the foundation of a permanent shack installation, these 12-pole Euro-style barrier strips ensure the best signal paths possible. They also make it easy to diagnose connectivity issues and present a professional appearance. The strips are rated to 300 volts.



Part Number	Rated Current	Wire Gauge	Pitch	Price
NTE-25-E2000-12	20A	20-12	8.2mm	\$5.99
NTE-25-E2100-12	30A	18-10	10mm	\$5.99
NTE-25-E2300-12	30A	12-10	15mm	\$7.59
NTE-25-E2200-12	50A	14-8	11.5mm	\$6.59



Solderless Nylon Terminal Kit

A great kit to have in your shack, this kit includes connectors that are tougher, better insulated and more corrosion-resistant than ordinary store-bought ones. You get 180 connectors for 22- to 18- and 12- to 10-gauge wire ranges, all packaged in a neat storage case.



SUM-890093 Solderless Nylon Terminal Kit **\$32.99**

Check out our YouTube channel for in-depth tech tips and product demos!



BIP-SC-4830JUD



LiFePO4 Batteries, Chargers, Solar Panels, and Solar Charge Controllers

Hams everywhere depend on the team at Bioenno Power for their line of trusted products that make portable operating a pleasure. Bioenno's LiFePO4 (Lithium Iron Phosphate) batteries offer big advantages over other options, including lower weight, increased capacity, enhanced power delivery, longer life, quiet EMI/RFI-free performance, and built-in module for protection against overcurrent, undervoltage, and overvoltage. Plus, all batteries come with the company's True Lithium Capacity Insurance Policy, meaning Bioenno inspects and quality checks every battery when it's stocked into inventory and when it's shipped.



LiFePO4 Battery Plus Charger Packages

BIP-BSP-28

DX Engineering makes it easy for you to get up and running quickly with these combos featuring a 12 VDC LiFePO4 battery paired with the correct 14.6 VDC, 110-220 VAC AC to DC charger. Batteries come in a PVC pack or ABS sealed case and have Powerpole discharge connector. Note: These batteries should be charged with a LiFePO4 compatible charger. SLA chargers are not compatible.

- BIP-BLF-1203AB-P 3 Ah, 7A, 84W, .88 Lbs.; 1502 Charger, 2A **\$71.98**
- BIP-BLF-1203W-P 3 Ah, 6A, 72W, .88 Lbs.; 1502 Charger, 2A **\$71.98**
- BIP-BLF-12045W-P 4.5 Ah, 9A, 108W, 1.10 Lbs.; 1502 Charger, 2A **\$86.98**
- BIP-BLF-1206A-P 6 Ah, 12A, 144W, 1.54 Lbs.; 1502 Charger, 2A **\$101.98**
- BIP-BLF-1208LB-P 8 Ah, 12A, 2.43 Lbs., ABS Sealed; 1502 Charger, 2A **\$116.98**
- BIP-BLF-1209A-P 9 Ah, 12A, 288W, 2.65 Lbs.; 1502 Charger, 2A **\$121.98**
- BIP-BLF-1209WS-P 9 Ah, 18A, 216W, 2.60 Lbs.; 1502 Charger, 2A **\$121.98**
- BIP-BLF-1212A-P 12 Ah, 20A, 240W, 3.31 Lbs.; 1502 Charger, 2A **\$146.98**
- BIP-BLF-1212AS-P 12 Ah, 20A, 240W, 3.53 Lbs., ABS Sealed; 1502 Charger, 2A **\$146.98**
- BIP-BLF-1215A-P 15 Ah, 30A, 360W, 4.19 Lbs.; 1504 Charger, 4A **\$174.98**
- BIP-BLF-1215AS-P 15 Ah, 30A, 360W, 4.30 Lbs., ABS Sealed; 1504 Charger, 4A **\$174.98**
- BIP-BLF-1220A-P 20 Ah, 40A, 480W, 5.40 Lbs.; 1504 Charger, 4A **\$217.98**
- BIP-BLF-1220AS-P 20 Ah, 40A, 480W, 5.73 Lbs., ABS Sealed; 1504 Charger, 4A **\$229.98**
- BIP-BLF-1230A-P 30 Ah, 60A, 360W, 7.94 Lbs.; 1506 Charger, 6A **\$318.98**

LiFePO4 Batteries

Bioenno LiFePO4 batteries can also be purchased individually. Individual batteries can be found at DXEngineering.com by entering the combo part numbers listed above without the letter P. Pricing from **\$49.99 to \$279.99**.



Battery Chargers

AC to DC chargers for 12V LiFePO4 batteries can also be purchased individually.

- BIP-BPC-1502CLIP LiFePO4 Battery Charger, 2A Output, Alligator Clips **\$21.99**
- BIP-BPC-1502DC LiFePO4 Battery Charger, 2A Output, DC Plug **\$21.99**
- BIP-BPC-1504CLIP LiFePO4 Battery Charger, 4A Output, Alligator Clips **\$24.99**
- BIP-BPC-1504DC LiFePO4 Battery Charger, 4A Output, DC Plug **\$24.99**
- BIP-BPC-1506A LiFePO4 Battery Charger, 6A Output, Powerpole PP45 **\$38.99**

Foldable Solar Panels

These easy-to-use, large-panel, high-output monocrystalline panel systems are perfect for Field Day and other applications when you're outside with plenty of sunlight but no access to the power grid. Enjoy clean, modulated, and EMI/RFI-free silent output. Note: Always use a Solar Panel with a matching Solar Charge Controller (sold separately, below) when used in conjunction with a battery.

- BIP-BSP-28 Solar Panel, 28W, 12-18 VDC, 1.55A Max Current **\$104.99**
- BIP-BSP-40-LITE Solar Panel, 40W, 15-18 VDC, 2.22A Max Current **\$124.99**
- BIP-BSP-60-LITE Solar Panel, 60W, 18 VDC, 3.33A Max Current **\$149.99**
- BIP-BSP-100-LITE Solar Panel, 100W, 18 VDC, 5.56A Max Current **\$209.99**
- BIP-BSP-120 Solar Panel, 120W, 18 VDC, 6.7A Max Current **\$234.99**

Solar Charge Controllers

These versatile controllers are designed for use in solar systems to charge LiFePO4, AGM, or SLA batteries. Featuring an LCD that shows usage status of the system, units provide a regulated output voltage to charge batteries and maintain loads. All units accept 12 VDC or 24 VDC input from solar panels. Model BIP-SC-4830JUD accepts 12, 24, 36, or 48 VDC.

- BIP-SC-122420JUD Solar Charge Controller, 20A, 12-50 VDC Input **\$49.99**
- BIP-SC-4830JUD Solar Charge Controller, 30A, 17-50 VDC Input **\$69.99**
- BIP-SC-122420NE Solar Charge Controller, 20A, 100 VDC Max Input **\$89.99**
- BIP-SC-122430NE Solar Charge Controller, 30A, 75 VDC Max Input **\$169.99**

For new hams, check out our Getting Started HT, Mobile, and Base Radio Packages!

REAMP High-Accuracy Power Consumption Logger



If you're working on an ultra-low power project, you'll want to add this unique device to your toolbox. To achieve the longest battery life possible, a very accurate and reliable power measurement tool is required. REAMP acts as a stable and accurate power source for the Device Under the Test (DUT). It allows subtle changes to be seen in the power consumption profile of the DUT. Features include high-accuracy wide range current measurements from 10 µA to 1 A; two channels for voltage measurement; 10 Hz to 10 kHz sample rate; built-in Li-Ion battery for cases when DUT current consumption is over 500 mA; and comprehensive power consumption analysis with ready-to-use multi-OS software for Windows, Linux, and MacOS. Enter "REU Logger" at DXEngineering.com for more details.

REU-REAMP REAMP High-Accuracy Power Consumption Logger **\$120.00**

A-POWER

Inverter Gasoline Generator

This portable 2,000W generator from A-iPower features an air-cooled, four-stroke engine; 1.1 gallon fuel tank; built-in inverter; two 120V outlets; recoil starting system; 65 dB operational volume (muffler is included); low-oil shutdown; 15 amp 120V circuit breaker; 1,600W maximum AC output; and 7-hour run time at 50% load. Perfect for your outdoor amateur radio adventures, the 46 lb. unit delivers clean, quiet, reliable, and convenient power when you need it. Enter "A-iPower" at DXEngineering.com for many more portable generator options.



AIP-SUA2000I 2,000W Inverter Gasoline Generator **\$399.99**

Deep Cycle Batteries



These AGM 12-volt batteries are ideal for Amateur Radio applications, or for any time you need long-lasting, portable power. They're spill-proof, vibration resistant and will mount in any position. The batteries are safe for indoor use and will survive long periods of slow discharge, making them perfect for EMCOMM trailers. You can also use these batteries in mobile installations that typically draw more power than your alternator can handle.



YellowTop Deep Cycle batteries have SAE automotive-style terminals while BlueTop Deep Cycle Marine batteries have both automotive-style terminals and threaded studs.

Part Number	Description	Cranking Amps at 0° F	Reserve Capacity	BCI Group Number	Price
ULT-9012-021	YellowTop	750	120 Minutes	34	\$309.99
ULT-9014-045	YellowTop	750	120 Minutes	34/7	\$309.99
ULT-9050-160	YellowTop	900	155 Minutes	31T	\$399.99
ULT-9051-160	YellowTop	900	155 Minutes	31A	\$399.99
ULT-9016-103	BlueTop	750	120 Minutes	34	\$329.99
ULT-9027-127	BlueTop	800	140 Minutes	27	\$359.99
ULT-9052-161	BlueTop	900	155 Minutes	31	\$399.99

Deep Cycle Batteries can only be shipped by ground.

Premium Battery Boxes

If your headlights dim when you transmit with that 500W mobile HF amplifier, you may need an extra battery plus a Summit Racing Premium Battery Box. These strong plastic battery boxes offer solid protection for auxiliary batteries and an extra battery to provide the reserve power that mobile amplifiers often need. The sealed-type boxes protect auxiliary batteries from moisture, dirt, and debris, while the vent tube expels battery gasses to prevent buildup. In-cab or in-truck mounting is possible if proper vent-tube installation is followed. User customizes each unit per vehicle application by drilling the battery box for cable and vent-tube access. Inside battery box dimensions are approximately 10.75" L x 8.5" W x 9" H. Mounting hardware included.



- SUM-G1230 Premium Battery Box, Red **\$93.99**
- SUM-G1231 Premium Battery Box, Black **\$93.99**

Battery Disconnect Switch

This switch gives you a quick way to positively shut off power from your battery. This combats unwanted drain, while helping to ensure that your battery remains charged until you need it. Rated for 20 amps continuous, it will also handle short duration surge loads of 125 amps.



SUM-G1432 Battery Disconnect Switch **\$30.99**

ELECRAFT

2-Tone Test Oscillator

Measuring Transmit Intermodulation Distortion (IMD) is critical when evaluating HF SSB transmitter or amplifier performance. This precision tool makes it simple. Elecraft's 2T-GEN provides a standard 2-tone (700 and 1900Hz) audio source for IMD testing, allowing you to quickly assess how linearity may be impacting SSB fidelity and splatter. The mini-module is a compact 2.5" W x 3.5" L and fits directly into the microphone connector of almost any transceiver. Battery not included.

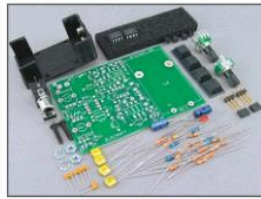

ECT-2T-GEN 2-Tone Test Oscillator\$99.95

ELECRAFT

Dual Directional Coupler

A welcome companion for Elecraft's 2-Tone Test Oscillator, the CP1 Dual Directional Coupler lets you easily sample a transmitter's forward power and reflected power output. The high-directivity coupler connects to an oscilloscope or station monitor for display of the transmit envelope. A handy tool for any shack, it can also be used with a diode detector to create a 25- or 250-watt SWR bridge, or with a spectrum analyzer and tracking generator to sweep the return loss (SWR) of an antenna or other device in real-time. The unit operates over a 1 MHz to 30 MHz frequency range.



ECT-CP1 Dual Directional Coupler, Full Kit\$79.95

ELECRAFT

Programmable Signal Source

Great for shack or field use, Elecraft's versatile miniature 160-2M RF signal source comes with four calibrated output levels and a host of performance-enhancing applications: receiver calibration, sensitivity tests, signal tracing, and as a VFO for home-brew projects. Its serial port allows you to use a computer to set up its frequency and output level, assign frequencies to band switches, and set up sweep step size and rate. You can use the downloadable PC software or write your own XG3 applications. Programmable Signal Source comes factory assembled and tested, not as a kit.



ECT-XG3 Programmable Signal Source\$299.95

ELECRAFT

140W Computing Wattmeter/SWR Bridge, Full Kit

Perfect for kit-building projects and QRP enthusiasts, this versatile microprocessor-based RF power and SWR meter makes simple work of monitoring your equipment. It automatically selects the proper power range of up to 1.4, 14 or 140 watts and indicates the peak forward power and SWR on built-in bar-graph LEDs. High resolution power and SWR readings are also available through a connector as RS232 serial data for display on a computer.

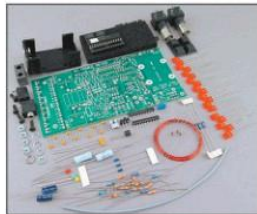

ECT-W1 Computing Wattmeter/SWR Bridge, Full Kit\$149.95

ELECRAFT

25 Watt Dummy Load, Full Kit

Test with confidence! A smart tool for any shack, this general purpose, wideband 50-Ohm Dummy Load lets you test or align your transceiver before connecting your antenna. The unit handles up to 20 watts continuous power, or higher power (up to 100 watts) in short bursts. It also includes a diode detector for measuring power output.

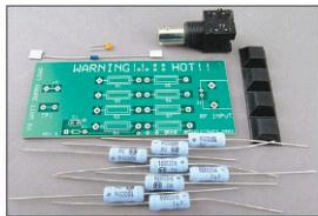

ECT-DL1 25 Watt Dummy Load, Full Kit\$33.95

ECG

100 MHz Oscilloscope Probe

An excellent replacement for a missing or damaged probe. It includes a ground-lead clip and hook attachment, plus an insulating tip and an IC tip. The versatile probe also comes with a BNC connector, making it compatible with most popular scopes. A 1x and 10x selector switch (with ground reference setting) makes this a versatile probe for electrical troubleshooting.



ECG-PR-100 Oscilloscope Probe\$41.99

ECLIPSE



ETL-MT-1510



ETL-MT-1506



ETL-MT-1280



ETL-MT-1210

Multimeters

DX Engineering carries a great selection of versatile, accurate, and convenient multimeters from Eclipse Tools. The full-featured and portable MT-1210 digital model features a backlit, 3.5-digit LCD screen for easy data reading, diode and transistor tester, continuity buzzer, and low-battery indicator. The rugged and backlit MT-1280 true AC RMS (root mean square) multimeter tests diodes, capacitors, transistors, and temperature (4F-1,832F temperature probe range). It performs capacitance tests to 2000uf and includes NCV detection. The MT-1506 pocket-sized model tests diodes/capacitors and measures true RMS AC ranges. The true RMS MT-1510 auto-ranging, 600V "Smart" multimeter features a large backlit LCD and resembles a smartphone so it will fit perfectly in just about any pocket. Required batteries not included on all models.

ETL-MT-1210	Compact Digital Multimeter.....	\$18.99
ETL-MT-1280	True RMS Multimeter.....	\$46.99
ETL-MT-1506	True RMS Pocket Multimeter.....	\$31.99
ETL-MT-1510	True RMS Pocket Smart Multimeter.....	\$39.99

ECG

9-Function Digital Auto Ranging Multimeter

A great addition to any ham's test bench or toolbox, this compact, economical and versatile instrument measures voltage, current, resistance and continuity, capacitance, temperature, frequency and more. Its data hold function freezes display for easy reading. The backlit device delivers true RMS response and comes with two AAA batteries, test leads, rubber shock-resistant outer case with place to store leads, and user manual.



ECG-DM-817 Digital Auto Ranging Multimeter\$45.38

ECG

Six-Function Digital Multimeter

This compact multimeter from the testing equipment leaders at ECG measures DC current up to 10A, DC and AC voltage to 600V, resistance, HFE, diode and continuity. The backlit unit comes with battery and test leads.



ECG-DM-850 6-Function Digital Multimeter.....\$15.49

ECG

DM-21 Digital Multimeter

Every Amateur Radio operator should have a good, reliable multimeter in their shack. The DM-21 fits the bill nicely, offering a ton of features at a budget-friendly price. It has seven different functions in 11 ranges, which makes it a versatile addition to any hobbyist's or professional's toolkit. In addition to the standard voltage, continuity, current and resistance metering, you can use the DM-21 to test diodes/LEDs and transistors. It even has an integrated square wave generator. It's over-current and polarity protected, and has a handy tilt-stand for workbench testing.



ECG-DM-21	Digital Multimeter.....	\$34.99
ECG-MC-50	Carrying Case for DM-21/59.....	\$7.99

ECG

DM-59 Digital Multimeter

This is an excellent meter for the homebrew designer, offering 10 functions in 30 ranges. This meter also has a precision capacitance tester, which is great for troubleshooting older gear. The DM-59 also bundles in a frequency measurement tool, covering 2 kHz to 15 MHz and accurate to +/- 0.1 percent. Find all the details on this meter at DXEngineering.com.



ECG-DM-59	Digital Multimeter.....	\$51.99
ECG-MC-50	Carrying Case for DM-21/59.....	\$7.99

DXEngineering.com is loaded with detailed photos, specs, videos, and more!



SBM-WSPRFLITEFLEX



SBM-LB-MODULE-GP



SBM-LOAD-KIT



SBM-BOXA-DUALKIT



SBM-PWR-CNDNR



WSPRlite Flexi Propagation and Antenna Tester

Building on the success of the classic WSPRlite, the WSPRlite Flexi is a special, low-power test transmitter that sends a signal on your antenna out to a worldwide network of receiving stations listening in the WSPR mode.

When used with the web-based DXplorer system, it's a powerful new way for contesters and DXers to evaluate antenna performance. This unique system of propagated signal analysis goes beyond antenna modeling or antenna analyzers and allows you to see how your antenna is performing in its actual location and in real-time!

WSPRlite Flexis are all soak tested to pre-age the TXCOs. They are then individually adjusted against a Rubidium standard. With this more accurate oscillator, SOTABeams has been able to increase the run time to 45 days. Additionally, the WSPRlite Flexi's Interference Avoidance Algorithm uses statistical data on the frequency distribution of WSPR transmitters to help it pick frequencies that are more likely to be clear.

The handy device enables you to perform antenna performance testing; compare any antennas (base, portable and mobile); compare locations and antennas—yours, your friends, even compare your antennas and location with the big guns; test beam antennas against dipoles versus verticals; and spot openings when you are out of the shack. The WSPRlite Flexi is capable of operating 630, 160, 80, 40, 30, 20, 17, 15, 12, 10 and 6 meters (5 more bands than the WSPRlite), but requires external low pass filtering through use of the 160/80/40M SBM-LOWPASSKIT.

SBM-WSPRFLITEFLEX	Propagation/Antenna Tester, WSPRlite Flexi, 630-6M \$99.99
SBM-LOWPASSKIT	WSPRlite 160, 80 and 40M Add-On Kit \$35.99
SBM-LOAD-KIT	Keep-Alive Load Kit \$12.99
SBM-PWR-CNDNR	WSPRlite Power Conditioner Kit \$15.99
SBM-PWR-CASE	Power Conditioner Kit Enclosure \$12.99
SBM-OTGY-100	On-the-Go Y Lead \$7.99

Adapter Cables for the WSPRlite Flexi

CMA-HS-05	RG-188, SMA Male/UHF Female, SO-239, 18" \$14.99
CMA-HS-10	RG-188, SMA Male/UHF Female, SO-239, 39" \$17.99
DMN-C104SMA	RG-58A/U, SMA Male/UHF Female, SO-239, 4' \$16.99
SBM-BNC-SMA	BNC Female to SMA Male Adapter \$9.99

LASERBEAM DSP Filter Modules

More effective at reducing QRM than mechanical or analog filters, these general purpose CW and SSB filter modules use special algorithm-based software to create well-defined passbands with steep contours.

SBM-LB-MODULE-CW	CW Filter, Passbands (550-850 Hz), (300-1300 Hz) \$39.99
SBM-LB-MODULE-GP	CW (550-850 Hz) SSW (300-2700 Hz) Filter \$39.99
SBM-LB-MODULESSB	SSB, Stnd. (300-2700 Hz), Narrow (300-2400 Hz) \$39.99
SBM-BOXA-DUALKIT	Amplifier/Enclosure Kit for LASERBEAM-DUAL Filters \$30.99



Shackmaster™ OSL Calibration Kit

Weighing only 5.6 ounces, this compact and precision-made three-in-one OSL calibration kit from RigExpert features a DC-2.5 GHz frequency range, three N-type 50 Ω standards, 250mW power rating, protection of connectors from external influences for higher accuracy, adjustable connector design, and return loss of -22 dB at 3 GHz and -31 dB at DC-1.5 GHz.

REU-OSL-KIT	OSL Calibration Kit \$89.99
-------------	---------------------	---------------



New!

Most in-stock parts ship throughout the contiguous US in just 1-2 days!



Filter Boards and Band Kits

SOTABeams Filter Boards and Band Kits are used for the WSPRlite Classic, WSPRlite Flexi, or for your SDR front-end filter projects. Choose the Low Pass Filter Board and Band Kit components for the specific bands on which you want to use your WSPRlite. Build these high performance seven-element Chebyshev low pass filters to eliminate harmonics and spurs. They function bi-directionally and may be used for QRP transceivers or for receive. Each three-band board features a manual band change jumper header and comes with an SMA male cable to connect to the WSPRlite and a board mount SMA female connector for your antenna feedline. Filters also work with QRP radios other than the WSPRlite Classic or Flexi.

SBM-PCB3BLPF

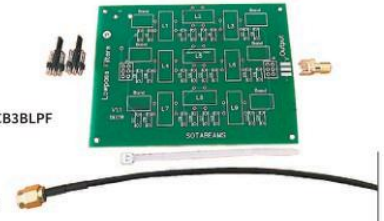

SOTABeams Filter Boards and Band Kits are available in these versions:

SBM-LOWPASSKIT	Low Pass Filter Kit for 160, 80 and 40 Meters, V 1.2 Board \$35.99
SBM-LOWPASSKITHB	Low Pass Filter Kit for 20, 15, and 10 Meters, V 1.2 Board \$35.99
SBM-PCB3BLPF	Three-Band Low Pass Printed Circuit Board Only, V 1.2 Board \$21.99

Includes board only, SMA connector and cable. Add specific component Band Kits for the bands you want to use.

SBM-PK160LPF	160M Band Kit for Low Pass Filter \$12.99
SBM-PK80LPF	80M Band Kit for Low Pass Filter \$12.99
SBM-PK60LPF	60M Band Kit for Low Pass Filter \$12.99
SBM-PK40LPF	40M Band Kit for Low Pass Filter \$12.99
SBM-PK30LPF	30M Band Kit for Low Pass Filter \$12.99
SBM-PK20LPF	20M Band Kit for Low Pass Filter \$12.99
SBM-PK17LPF	17M Band Kit for Low Pass Filter \$12.99
SBM-PK15LPF	15M Band Kit for Low Pass Filter \$12.99
SBM-PK12LPF	12M Band Kit for Low Pass Filter \$12.99
SBM-PK10LPF	10M Band Kit for Low Pass Filter \$12.99
SBM-PK6LPF	6M Band Kit for Low Pass Filter \$12.99

SOTABeams Bandpass Filter for 2 Meters

This unit is made for the top of an HT that is being used in areas with high RF levels with multiple transmitters. In these places, the HT can suffer from front end overload and signal blocking. This bidirectional bandpass filter can prevent that out-of-band signal overload.

SBM-BPFT-100	2M Bandpass Filter \$57.99
--------------	--------------------	---------------



Enclosure Kits for SOTABeams Low Pass Filter Kits

Sturdy and easy to assemble, DX Engineering's enclosure kits are custom made to securely house SOTABeams Low Pass Filter Kits. It only takes a few simple steps to mount the filter and build the box. Everything you need is included: top and bottom pieces for the aluminum case, PCB spacers, hardware and stick-on rubber feet. The enclosures have a soft grommet to protect the SMA cable and two easily removable hole covers to allow bandswitching of the optional filter assembly. The new V 1.2 enclosure (DXE-LPFV1-2-CASE) has been designed to house the SBM-LOWPASSKIT, SBM-LOWPASSKITHB and SBM-PCB3BLPF.

DXE-LPFV1-2-CASE	Enclosure Kit for SOTABeams Filter Kits, V 1.2 \$55.99
------------------	--	---------------



CAA-500 Mark II Antenna Analyzer

Improving on the revered CAA-500, the Mark II edition adds a full color LCD screen. The new display can show graphical and numerical SWR, total impedance (with X and R values), frequency and battery life. SWR and impedance are displayed simultaneously, allowing you to easily determine resonant frequency.

The analyzer will scan a frequency range in mere seconds, to make antenna adjustments and troubleshooting much quicker. The analyzer has broad frequency coverage, twin analog meters and two antenna connection jacks. It is powered by six AA batteries, which provide up to 14 hours of operation.

CMA-CAA500MARKII	Antenna Analyzer \$399.99
CMA-CAA-55C	Carrying Case \$42.99



Antenna Analyzers



Use these analyzers to test your antennas and feedlines. Enjoy using an affordable, professional-grade tool for antenna building, troubleshooting and repairs. Professionals have trusted RigExpert analyzers since 2003, yet their simple interfaces and straightforward controls make them ideal for hobbyists as well. You can use them for checking coax cable assemblies and measuring the capacitance or inductance of reactive loads.

They're powered by standard AA batteries, or a 5V USB port. You can move across the frequency range in 1 kHz steps, and the minimum sweep range is an impressive 10 kHz. Unlock even more features of these multi-lingual analyzers by connecting them to a PC.

RigExpert's SWR2AIR mode turns antenna adjustment into a one-person job. It works by transmitting the SWR measurement on a user-specified frequency, so you can hear it on an HT. Simply listen to the length of the audio signal to determine the SWR value. RigExpert Antenna Analyzers come with zoom-in capabilities for clearer analysis of graphic points. The AA-3000ZOOM features a large 800x480 pixel color TFT display with BlanView® technology, which provides high-contrast, crisp images even when sunlight hits the display directly.

Built-in Bluetooth

The RigExpert AA-230ZOOMBT and REU-AA-3000ZOOM models, along with Stick Antenna Analyzers below, come with built-in Bluetooth capability. With Bluetooth wireless communications technology integrated in your analyzer, you can use it in conjunction with a tablet, notebook, smartphone or laptop with Bluetooth to send and save files; operate remotely; view characteristics of your antenna in more detail; file and share measurement results; and much more. Enter "Bluetooth Analyzer" at DXEngineering.com.

See the quick specs below for each analyzer and get more detailed information at DXEngineering.com.



REU-AA-3000ZOOM

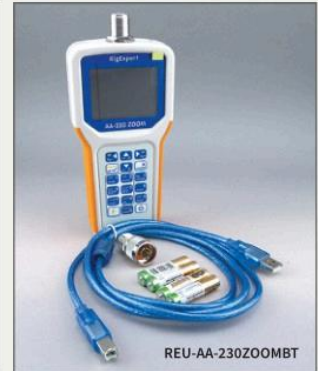

REU-AA-230ZOOMBT

Part Number	Frequency Range	Connector	SWR2AIR Mode?	MultiSWR Mode?	Reference Impedances	Screen (Pixels)	Price
REU-AA-35ZOOM	0.06 - 35 MHz	SO-239	Yes	Yes	25, 50, 75 & 100 Ω	Color (320 x 240)	\$299.99
REU-AA-55ZOOM	0.06 - 55 MHz	SO-239	Yes	Yes	25, 50, 75 & 100 Ω	Color (320 x 240)	\$359.99
REU-AA-230ZOOMBT	0.1 - 230 MHz	SO-239	Yes	Yes	25, 50, 75 & 100 Ω	Color (320 x 240)	\$479.99
REU-AA-650ZOOM	0.1 - 650 MHz	Type N (F)	Yes	Yes	25, 50, 75 & 100 Ω	Color (320 x 240)	\$769.99
REU-AA-1500ZOOM	0.1 - 1500 MHz	Type N (F)	Yes	Yes	25, 50, 75 & 100 Ω	Color (320 x 240)	\$999.99
REU-AA-2000ZOOM	0.1 - 2000 MHz	Type N (F)	Yes	Yes	25, 50, 75 & 100 Ω	Color (320 x 240)	\$1,199.99
REU-AA-3000ZOOM	0.1 - 3000 MHz	Type N (F)	Yes	Yes	25, 50, 75 & 100 Ω	Color (800 x 480)	\$1,299.99

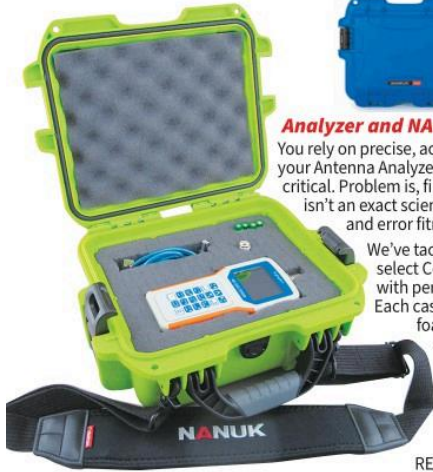

Analyzer and NANUK Case Combos

You rely on precise, accurate diagnostic information from your Antenna Analyzer, so keeping it safe and protected is critical. Problem is, finding a case that fits your analyzer isn't an exact science, and there's usually a lot of trial and error fitment involved.

We've tackled that headache for you, pairing select Comet and RigExpert Antenna Analyzers with perfectly sized NANUK equipment cases. Each case will be filled with cubed, sectioned foam, so you can remove the exact amount you need. Plus, you can remove additional foam if you'd like to include any extra connectors or accessories that may fit in your case.

The combos are available in a range of NANUK case colors, including new RED and BLUE options. We've listed a few combos below.

Enter "NANUK Combo" at DXEngineering.com for more specs.

Part Number*	Analyzer Model	NANUK Case Model	Price
DXE-35ZOOM-910_	RigExpert AA-35 ZOOM	910 Series	\$384.94
DXE-55ZOOM-910_	RigExpert AA-55ZOOM	910 Series	\$462.98
DXE-230ZOOMB905_	Rig Expert AA-230ZOOMBT	905 Series	\$563.94
DXE-MARKII-905_	Comet CAA-500 Mk II	905 Series	\$483.94
DXE-650ZOOM910_	RigExpert AA-650ZOOM	910 Series	\$854.94
DXE-1500ZOOM-910_	RigExpert AA-1500ZOOM	910 Series	\$1,084.94
DXE-2000ZOOM-910_	RigExpert AA-2000ZOOM	910 Series	\$1,284.94
DXE-3000ZOOM-910_	RigExpert AA-3000ZOOM	910 Series	\$1,384.94

*The last character in the part number denotes case color and is left blank. Select your case color at DXEngineering.com. Discontinued AA-170 and AA-30 models fit 910 Series case.



REU-STICK-XPRO

REU-STICK-500

REU-STICK-230

REU-STICK-PRO

Stick Antenna Analyzers

The RigExpert Stick 230 antenna analyzer delivers exceptional coverage (0.06-230 MHz) and a range of options for viewing results. The unit provides accurate measurements for 25 through 600 Ω systems. Display modes include SWR (return loss, R, X, Z, L, C, magnitude and phase angle at single frequency); SWR chart (100 points); SWR chart at fixed Ham bands by IARU regions (100 points); and multi-mode for proper checking of multi-band antennas. The Stick 230 analyzer features integrated Bluetooth technology, USB connection to a PC, and waterproof keypad. For wider coverage and the same great functionality and ease of use, choose the Stick-Pro (0.1-600 MHz). Joining the growing family of RigExpert stick analyzers are the Stick 500 (100 kHz-500 MHz) and Stick XPRO (0.1-1,000 MHz) models. All devices measure 7.3" x 1.6" x 1.3" and weigh an easy-to-transport 6.5 ounces.

REU-STICK-230	0.06-230 MHz Stick 230 Antenna Analyzer	\$329.99
REU-STICK-500	100 kHz-500 MHz Stick 500 Antenna Analyzer	\$399.95
REU-STICK-PRO	0.1-600 MHz Stick-Pro Antenna Analyzer.....	\$479.99
REU-STICK-XPRO	0.1-1,000 MHz Stick-XPRO Antenna Analyzer	\$679.95
REU-STICK-HOLDER	Stick Analyzer Belt Holder.....	\$15.00

Join our crew on Facebook for news and exclusive deals!

miniVNA PRO2 BT and Tiny Network Analyzers



With a frequency range of 1 to 3,000 MHz, the Tiny model (2.6" x 2.6" x 1.1") tests for SWR and impedance, and can be used for transmission measurements on band filters or amplifiers. As a vectorial analyzer, it can perform quadrupole measurements of S11 and S21 parameters, with the results displayed and stored as a Smith diagram. Power supply and software upgrades are available via USB interface; an external power supply is not required. Impedance (Z) can be measured from 1 to 1,000 Ω; dynamic range is up to 70 dB. The device can be used as a low power HF generator as well. Other features include SMA connectors for better isolation; ability to export in a variety of formats; full phase measurement; and boot loader for firmware upgrades.

The updated miniVNA PRO2 version is a dual port unit as well, with 100 kHz to 200 MHz/10 kHz to 230 MHz frequency ranges. It includes a 1000mAh battery, providing four hours of full-scan operation, and a wireless Bluetooth interface—enhancements that allow you to use the analyzer directly at the antenna's feedpoint. Other features include impedance range from 1 to 1,000 Ω; built-in USB battery charger; two separate buffered RF outputs for I/Q for SDR experiments and IMD test with independent 0-55 dB attenuator; extended dynamic range: up to 100 dB for transmission, up to 50 dB for reflection; and user-friendly interface for PC Windows, Linux, and MAC. Both models can be used with optional WMO 50 Ohm SMA Calibration Kit, which includes one 50 Ω load, one short, and one open.

- WMO-MINI-VNA-PROBT miniVNA PRO2 BT Wireless Vector Network Analyzer\$449.99
- WMO-MINI-VNA-TINY miniVNA Tiny Vector Network Analyzer\$525.99
- WMO-21010-SMA 50 Ohm SMA Calibration Kit.....\$31.99

ZERO II VNA Project Board

For you DIYers and out-of-the-box experimenters, RigExpert's latest VNA project board is a small, flexible, and low-cost option for hams and hobbyists looking for a measuring device that can be integrated into a project. While it has no keyboard or readout, the ZERO II (100 kHz-1,000 MHz frequency range) comes with an onboard USB port to allow for a connection to a computer to quickly perform common measurements such as resistance, reactance (signed), SWR, and return loss. The ZERO II is compatible with RigExpert AntScope software and can be paired with common Arduino boards for hardware/software projects. Only limited by your imagination, the ZERO II can be used to build an automatic antenna tuner, perform RF circuit or antenna analysis remotely, fine-tune an antenna's driven elements, and much more.



- REU-ZERO-II ZERO II VNA Project Board\$100.00

DX ENGINEERING

OSL Calibration Set for RigExpert Antenna Analyzers

The OSL (Open-Short-Load) Calibration Set allows the measurement reference plane of advanced RigExpert analyzers (AA-55ZOOM and higher) to be moved to the far end of a transmission line for accurate measurement of any antenna in its proper operating location. After selecting your analyzer's "Calibrate" function and attaching the Open, Short and Load calibration standards to the end of a coaxial cable as directed, you can view the "true" characteristics of the antenna under test, as if the analyzer were connected directly to the antenna feedpoint. Open, Short, and Load standards are built into high-quality silver-plated chassis mount SO-239 (UHF female) connectors.



- DXE-OSL-CAL-SET OSL Calibration Set\$65.99

CHELEGANCE JNCRadio

OSL Calibration and Coaxial Adapter Kits

These kits combine Chelegance's Open, Short, and Load SMA male calibration standards with three coaxial adapter types; choose the set that mates with your analyzer. Open, Short, and 50 Ω Load are used for analyzers that support automated OSL calibration. Using the included adapters, the calibration connectors can be placed, one at a time, directly on a network analyzer or antenna analyzer. On some analyzers, calibration connectors may be used at the end of coaxial cable to account for the complex impedance changes that connectors and cable lengths cause in RF systems. This process provides the most accurate measurements of the characteristics of the antenna.



- OSL Calibration Kits
- NCE-CH0030023-M 3 Standards SMA Male/3 SMA Female-UHF Male Adapters; \$34.99
- NCE-CH0030023-N 3 Standards SMA Male/3 SMA Female-N Male Adapters..... \$34.99
- NCE-CH0030023-B 3 Standards SMA Male/3 SMA Female-BNC Adapters\$34.99

Mini Vector Network Analyzers

Following up on the well-respected heels of the NANOVNA-F network analyzer, the JNCRadio VNA 3 GHz Portable Vector Network Analyzer from Chelegance offers an impressive coverage range (50 kHz through 3 GHz), with an improved sweep speed of 400 points/sec—four times faster than the NANOVNA-F. It features an upgraded and optimized user interface for maximum convenience and efficiency when performing a range of measurements, plus loads of ham-friendly perks, such as its 4.3" IPS touch screen and a 5000mA rechargeable internal battery housed in an aluminum case with SMA connectors. The unit can be used for measuring SWR, impedance, reactance, phase, delay, and Q factor of RF circuits, filters, duplexers, amplifier strip lines, cables, antennas, and many other applications. It has a dynamic range of 70dB for S21 and 50dB for S11. Displaying in linear, polar and Smith Chart plots, the CE-, FCC- and RoHS-compliant device comes with an SMA Open-Short-Load Calibration Kit (NCE-CH0020004), RG405 cable, stylus, SMA adapters, and USB Type-C cable.



- NCE-CH0010005 JNCRadio 3 GHz Portable Vector Analyzer\$279.99

NANOVNA-F V2 3 GHz Mini Vector Analyzer

The NANOVNA-F provides exceptional 3 GHz coverage and tons of functionality in a small package. It has an S21 dynamic range that's greater than 70dB at 50kHz-1.5GHz and greater than 60dB at 1.5GHz-3GHz; the ability to function up to a continuous 7 hours due to its low-power design and 5000mAh rechargeable internal battery; sturdy metal enclosure; and easy firmware upgrades. It comes with Open-Short-Load Calibration Kit, RG405 cable, stylus, SMA adapters, and USB Type-C cable. Also available is the RF Demo Kit for VNA, featuring 18 RF circuits to demonstrate how each appears on the display when using a vector network analyzer.



- NCE-NANOVNA-F-V2 NANOVNA-F V2 3 GHz Mini Vector Network Analyzer\$189.99
- NCE-CH0020004 Open-Short-Load Calibration Kit for VNAs\$15.99
- NCE-CH0020003 RF Demo Kit for VNAs.....\$23.99
- NCE-CH0020005 JNCRadio SMA Adapter Kit, Type-N to SMA\$20.99
- NCE-CH0020006 JNCRadio SMA Adapter Kit, PL-259 and SO-239 to SMA.....\$20.99
- NCE-CH0020007 JNCRadio SMA Adapter Kit, BNC to SMA.....\$20.99
- NCE-CH0020008 Coax Adapter Assembly for VNA, RP-SMA Female to IPX, 7.9", Set of 2\$8.99
- NCE-CH0020010 Type-N/UHF Coaxial RF Connector Adapters, Set of 4\$19.99
- NCE-CH0030001 BNC Male to SO-239/UHF Female Right Angle Coaxial Adapter, Pair.....\$18.99

CHELEGANCE JNCRadio

SV4401A Handheld Vector Network Analyzer

Covering 50 kHz-4.4 GHz, the dual-port handheld SV4401A (7.480" W x 5.118" H x 1.181" D) features a 7" capacitive touchscreen display. It can be used to measure/analyze antenna or coax parameters such as SWR, impedance, loss, and antenna phase; tune filters; test amplifiers, attenuators, cables, couplers, and duplexers; and display results in a variety of formats including Log Mag, Linear Mag, Phase, Smith R+jX, Smith R+L/C, VSWR, Polar, Group Delay, Resistance, and Reactance. The unit includes adapters and connectors, 19.5" of RG-316 cable, gold-plated SMA Load/Open/Short calibration kit, 3350AH 18650 Li-Ion rechargeable batteries, and case. Enter "SV4401A" at DXEngineering.com for more details.



- NCE-CH0010006 SV4401A Handheld Vector Network Analyzer\$569.99

SV6301A VNA Handheld Network Analyzer

New!

Perform a variety of measurements with the SV6301A network analyzer, featuring 1 MHz-6.3 GHz coverage; built-in 8GB TF memory card; 7" high-brightness, IPS capacitive touchscreen; and 1,001 ScanPoints. Kit includes USB Type-C cable for recharging, SMA calibration kit, two 3350 mAh Li-Ion batteries boasting three hours of life, and two 60cm SMA-JJ SS405 coaxial cables.



- NCE-CH0010011 SV6301A Handheld Vector Network Analyzer.....\$999.99

Clear the Air.

When Marconi first began experimenting with a spark gap transmitter, he didn't have to worry about RFI. Nowadays though, everything from household appliances to overhead power lines can pollute the radio spectrum. If you're dealing with unwelcome noise (QRN) in your shack, there are solutions. Check out the chokes, ferrite beads, noise finders and audio enhancers found in this catalog.

Orders over \$99 qualify for FREE standard shipping—see pg. 74 for details.



BongoTies

Multi-Purpose Tie Wraps

Here's a great way to get a handle on your growing coaxial cable collection. Originally designed as a sturdy cable tie for Hollywood movie grips, sound technicians, and photographers, five-inch-long BongoTies have grown to become a long-trusted solution in the shack and around the house. They're made from two organic renewable materials: bamboo and natural Hevea rubber. The versatile, professional-quality wraps can perform an array of tasks, including securing coaxial and control cables, computer and TV cables, appliance and power tool cords, and holiday lighting. They can also be employed to tie down tarps; secure banners; clamp items while gluing; and attach items to backpacks, bikes, and luggage. They come in packs of ten in your choice of colors, from natural bamboo to tree frog green.

BGO-A5-01	10 BongoTies, Natural Pin, Black Rubber	\$8.99
BGO-A5-01-B	10 BongoTies, Blue Pin, Blue Rubber	\$8.99
BGO-A5-01-G	10 BongoTies, Green Pin, Green Rubber	\$8.99
BGO-A5-01-R	10 BongoTies, Red Pin, Red Rubber	\$8.99
BGO-B5-2	10 BongoTies, Natural Pin, Natural Rubber	\$8.99
BGO-D5-01-B	10 BongoTies, Azure Blue Pin, Black Rubber.....	\$8.99
BGO-D5-01-G	10 BongoTies, Tree Frog Green Pin, Black Rubber	\$8.99
BGO-D5-01-K	10 BongoTies, Obsidian Black Pin, Black Rubber	\$8.99
BGO-D5-01-R	10 BongoTies, Lava Red Pin, Black Rubber	\$8.99

Stow-It Wrap Ties

Manage your cabling, guy wires, or any other supplies that need tidy storage. Constructed from weather-resistant 900 denier ballistic nylon, these 3" x 23" hook-and-loop ties will keep your equipment and supplies exactly where you put them. Metal grommet for hanging included. Rated up to 150 pounds.

ETL-902-511 Stow-It Wrap Cable Tie..... **\$4.99**



Hook and Loop Cable Ties

These straps are reusable and are made from soft material to prevent damaging the cable jacket. They're good for indoor and outdoor use and are sold in packs of 10. More color options are available at DXEngineering.com.



Part Number	Length	Width	Weight Rating	Color	Price
NTE-04-0640HLO	5.91"	0.47"	40 Lbs.	Black	\$7.29
NTE-04-0640HLMC	5.91"	0.47"	40 Lbs.	Assorted	\$8.99
NTE-04-0840HLO	7.87"	0.47"	40 Lbs.	Black	\$8.59
NTE-04-0840HLMC	7.87"	0.47"	40 Lbs.	Assorted	\$8.59
NTE-04-1040HLO	9.45"	0.51"	40 Lbs.	Black	\$8.99
NTE-04-1040HLMC	9.45"	0.51"	40 Lbs.	Assorted	\$8.99



Zip Ties

Quite possibly the most versatile tools in your shack, you can use these ties for cable management, field repairs, securing gear and more. They are made in UV-resistant black and come in several sizes.

DXE-1860-100	Zip Ties, 4", Pack of 100	\$5.59
DXE-1861-100	Zip Ties, 8", Pack of 100	\$6.79
DXE-1862-100	Zip Ties, 11", Pack of 100	\$9.99
DXE-1863-100	Zip Ties, 14", Pack of 100	\$10.99



10-Piece Alignment Trimming Tool Set

Making delicate adjustments to trimmer capacitors, resistors, and inductors just got a whole lot easier thanks to Eclipse's 10-Piece Alignment Trimming Tool Set. It comes with 10 different tips, including slotted, hexagonal, square, and inverse types to handle any job.

ETL-1PK-A001 Alignment Trimming Tools, Set of 10... **\$4.59**



Magnifier Lamps

For highly detailed work, turn to Eclipse Tool's Round Lighted 4X Magnifier (ETL-900-125). This handy and economical bulb-lighted magnifier has a 2.5" diameter lens for close-up soldering. The ETL-902-109 Workbench Inspection Lamp features a fully-adjustable spring-balanced arm that stays in position where you need it; 5 diopter (2.25X magnification); circular fluorescent 22W T5 tube; and bench clamp that fits up to 2.6" thick surfaces. Dust-proof lens cover included.

ETL-900-125 Round Lighted 4X Magnifier **\$4.99**
 ETL-902-109 Workbench Inspection Lamp..... **\$54.99**



Desktop Inspection Lamp

This versatile magnifying workbench lamp from Eclipse Tools will help you get a closeup look at your projects, whether you're building a kit or performing delicate soldering. The lamp features 2.25X (5D) magnification, a 700 lumen LED, desktop clamp, adjustable arm, and scratch-resistant glass lens. One satisfied user called it "an excellent light for the workbench with plenty of illumination, and the magnifier is perfect for intricate work."

ETL-MA-1209LA Desktop Inspection Lamp **\$107.99**



Vises and Accessories

The next best thing to an extra pair of hands, these vises and accessories allow you to put your project in virtually any position. That makes complex soldering jobs and wire routing much easier, especially in tight chassis. Many styles are available to suit your specific needs.

PVP-301	Original PanaVise, Nylon Jaws, 2.25" Jaw Width, Standard Base	\$61.99
PVP-380	300-Series Vacuum Base, Accepts Many Head/Mount Combos	\$57.99
PVP-203	PanaVise Jr. Head, .875" Width, 5/8" Shaft for 300-Series Base	\$27.99
PVP-381	Original PanaVise, Nylon Jaws, 2.25" Jaw Width, Vacuum Base.....	\$87.99
PVP-201	PanaVise Jr. Mini-Vise, 2.875" Jaw Width, Standard Base.....	\$36.99



Stainless Steel Digital Caliper

The only way to make precise outside, inside, step and depth measurements, this ultra-accurate caliper is made to provide years of service. A large LCD screen makes it easy to use. The caliper also features SAE-to-metric conversion, an on/off switch, locking thumb wheel and an instant zero setting.

SUM-900001 Stainless Steel Digital Caliper **\$34.99**



Braided Wire Wraps

Use these wraps to add extra protection to your wires, tidy up a crowded chassis, improve cable management or to add a slick custom look to your homebrew projects. They're made from a heat resistant, woven polymer fiber that's split lengthwise so you can easily slip in your wire bundle. The wraps come in different lengths and diameters.

Part Number	Diameter	Length	Price
SUM-890340	1/4"	20'	\$13.99
SUM-890341	1/2"	10'	\$17.89
SUM-890342	3/4"	6'	\$14.99
SUM-890343	2"	4'	\$26.99



Need help with your project? Call the tech line at 330-572-3200!



AMB-3138-150

AMB-3138X-175

Heavy-Duty Soldering Irons

Well suited for assembly line electronic production, these irons can handle constant use. They feature an innovative compression-wound heating element that can maintain a constant temperature. The 100-250 watt irons include a diamond tip; the tip is sold separately for the AMB-3178LT-300.

AMB-3138-100	Heavy-Duty Iron, 100 Watts.....	\$158.00
AMB-3138-150	Heavy-Duty Iron, 150 Watts.....	\$158.00
AMB-3138X-175	Heavy-Duty Iron, 175 Watts.....	\$153.00
AMB-3158-200	Heavy-Duty Iron, 200 Watts.....	\$220.00
AMB-3158X-250	Heavy-Duty Iron, 250 Watts.....	\$230.00
AMB-3178LT-300	Heavy-Duty Iron, 300 Watts.....	\$224.00

Pencil-Style Soldering Irons

Professional quality irons, priced for the hobbyist. You can rely on them to provide consistent temperatures for all of your projects. They're comfortable and maneuverable, ideal for tight chassis and precise solder joints.

AMB-3110-30	Pencil-Style Iron, 30 Watts.....	\$80.00
AMB-3112-60	Pencil-Style Iron, 60 Watts.....	\$92.00

More Soldering Irons Online - You'll find a huge range of soldering irons available at DXEngineering.com. You'll be able to select the perfect iron for your bench online.

Dri-Wick Desoldering Braids



Whether you're working on a PCB or point-to-point circuits, Dri-Wick Desoldering Braids will make desoldering jobs much easier (and much safer for your gear). This 100 percent copper wick is coated with flux, which will help the solder pull cleanly and quickly off of the component.



Part Number	Braid Width	Spool Length	Price
AMB-484-1G	.035"	5'	\$4.50
AMB-484-2G	.055"	5'	\$4.75
AMB-484-3G	.075"	5'	\$5.00
AMB-484-4G	.098"	5'	\$5.25
AMB-484-5G	.130"	5'	\$5.50
AMB-485-8C	.093"	8'	\$7.25

Flux Pen



Apply your solder flux with ease and precision, and keep your PCBs clean and attractive. Kester 186 is an RMA-type flux that retains high thermal stability, and any residue left after soldering is typically OK for most electrical applications.

KTR-83-1000-0186	Flux Pen.....	\$12.99
------------------	---------------	----------------

ISO-TIP Silver Bearing Solder Paste



Make your tough soldering job easier. Simply use the syringe to apply ISO-TIP's Solder Bearing



Paste to your solder joint, hit it with your iron and the solder will flow right in—no mess and no clumsy wire feeding. It works with all ferrous and non-ferrous materials, including steel, bronze, chrome, silver and more. That means it's perfect for wires, cable, connectors, plumbing/piping, and more. Read how it works at DXEngineering.com.

ISO-7459	Silver Bearing Solder Paste.....	\$12.99
----------	----------------------------------	----------------



DeoxIT® Rosin Soldering Flux

Formulated to improve solder flow, this non-corrosive flux can be wiped off easily without leaving a residue.



CAG-RSF-R80-2	DeoxIT Rosin Soldering Flux.....	\$9.99
---------------	----------------------------------	---------------

Soldering Tip Cleaner

Enjoy smoother solder flow with this compact and convenient coiled-wire type cleaner. The brass wires won't burn or allow solder to stick. And since it's used dry, the coils won't cool your iron when you clean the tip. All it takes is a quick wipe of your iron through the steel-wool style cleaning ball.



ECG-JA-20	Soldering Tip Cleaner.....	\$8.65
-----------	----------------------------	---------------

Solder

Kester has over a century of experience making the finest quality solder on the market. This solder is ideal for sensitive electronic and telecommunication equipment. This chart is just the tip of the iceberg, visit DXEngineering.com for more solder options.



Part Number	Type	Gauge	Melting Point (F)	Price
1 Lb. Spool				
KTR-14-6040-0125	No Flux Core	8	361°	\$74.99
KTR-24-6337-8817	245, No-Clean	14	361°	\$51.99
KTR-24-6337-6411	331, Water Soluble Flux	14	361°	\$44.99
KTR-24-6040-9710	RMA Rosin Core	22	361°	\$75.99
KTR-24-6040-0061	44 RA Rosin Core	14	361°	\$42.99
KTR-24-6337-0027	44 RA Rosin Core	20	361°	\$59.99
KTR-24-6040-0027	44 RA Rosin Core	20	361°	\$54.99
KTR-6040-0066	44 RA Rosin Core	11	361°	\$41.99



Butane Soldering Kit

If you've got a base station antenna, then you already know how handy a portable soldering iron is. The J-700KT can be used as a soldering iron, hot knife, torch or heat gun. That means it's perfect for replacing connectors, repairing solder joints, or even melting ice from guy lines and antenna elements. It reaches operating temperature in seconds, and you can set the temperature from 410 to 850 degrees F, equivalent to a 25-80 watt electrical iron. (Torch operation reaches 2,500 degrees F.) At its mid-level setting, a single canister of butane will last for about 120 minutes of continuous use.



ECG-J-700KT	Butane Soldering Kit.....	\$62.99
ECG-JT-002	Replacement Chisel Tip for J-700KT.....	\$12.49

Pencil Style Soldering Irons

These are excellent irons for your shack, toolbox or road-kit. They're available in multiple temperature ratings and boast a precision conical tip. A folding iron stand is included.

ECG-J-060VT	Conical Tip 25-60 Watts.....	\$23.99
-------------	------------------------------	----------------



M12 Soldering Iron Kit

Milwaukee's M12 Soldering Iron delivers fast application speeds by reaching operational temperature in under 18 seconds and by maintaining an optimized temperature throughout even the most demanding jobs. Its heat indicator notifies users when the tool is ready to use and safe to store, eliminating guesswork. The three-stop pivoting head provides unmatched access by letting users adapt the tool for the application and solder in more confined spaces. The M12 Soldering Iron, powered by REDLITHIUM technology, delivers up to 40 minutes of run-time on an M12 compact battery pack. The soldering iron kit includes a rechargeable M12 REDLITHIUM Li-Ion battery, charger, and carrying case.



New!



MWT-2488-21	M12 Soldering Iron Kit.....	\$159.00
-------------	-----------------------------	-----------------

Summit Racing™ Wraparound Safety Glasses

Don't forget to wear a good pair of safety glasses when soldering connectors, mounting components on a circuit board, or doing any soldering work to prevent particulates and chemicals from damaging your vision. These Summit Racing wraparound safety glasses feature polycarbonate lenses plus a stylish wraparound design that fits close to help reduce the risk of eye injuries whether you're working in the shack or garage. Summit Racing™ Bifocal Safety Glasses also available.



SUM-P186	Wraparound Safety Glasses, Chrome Lens.....	\$6.99
SUM-P187	Wraparound Safety Glasses, Amber Lens.....	\$6.99
SUM-P188	Wraparound Safety Glasses, Orange Lens.....	\$6.99
SUM-P189	Wraparound Safety Glasses, Gray Lens.....	\$6.99
SUM-P190-10	Bifocal Safety Glasses, 1.0 Diopter, Clear.....	\$10.99
SUM-P190-15	Bifocal Safety Glasses, 1.5 Diopter, Clear.....	\$10.99
SUM-P190-20	Bifocal Safety Glasses, 2.0 Diopter, Clear.....	\$10.99
SUM-P190-25	Bifocal Safety Glasses, 2.5 Diopter, Clear.....	\$9.99

Orders by 10 pm ET ship the same day. See pg. 74 for details.

Eclipse Tools

For more than two decades, Eclipse Tools has continued to deliver a growing line of high-quality, value-priced tools for professionals as well as amateur radio enthusiasts who depend on their reliable soldering irons and stations, magnifier lamps, and heat guns to make easy work of upgrades and repairs. DX Engineering is now proud to bring Eclipse's shack-friendly tools to your station, including heavy-duty cable cutters, screwdriver sets, wrist straps, static mats, wire strippers, desoldering pumps, and digital multimeters. Enter "Eclipse" at DXEngineering.com.



ETL-SS-206EU



ETL-SI-B166



ETL-SS-331E



ETL-SI-168U

Soldering Irons and Soldering/Desoldering Stations

The SS-207E Digital Controlled Soldering Station features easy-to-read digital temperature display; temperature range of 392-896°F; stable power and fast thermal recovery; an insulated and ergonomically designed soldering iron handle for comfortable operation; and CE, ESD safety certification. The compact SI-168U 8W Portable USB Soldering Iron heats up in 15 seconds and cools down in 30 seconds; has a maximum temperature of 896°F; comes with a replaceable long-life tip; and features a power indicator to avoid accidental burns. The SI-B166 fast-heating Wireless Power Soldering Iron runs on a provided rechargeable 2200 mAh Li-Ion battery (1.5-hour run time on full charge). It comes with a stand that doubles as a recharger or iron holder. Tip cleaning ball and detachable power cord included. Eclipse's LCD Desoldering Station makes handling lead-free desoldering projects a breeze. It features single-handed operation and a fast heating, ceramic element with a temperature range that's adjustable from 320-896°F with a simple push of a button.

ETL-SS-207E	Digital Temperature Controlled Soldering Station	\$129.99
ETL-SI-168U	Portable USB Soldering Iron	\$10.69
ETL-SI-B166	Wireless Power Soldering Iron	\$60.99
ETL-SS-331E	LCD Desoldering Station	\$211.25
ETL-SS-331N-NZ	Desoldering Station Replacement Tips, Set of 3	\$14.49

6-Piece Soldering Tool Set for Printed Circuit Boards

These specialized, double-sided tools can make a major difference when performing delicate soldering work on printed circuit boards. They're designed to bend and hold leads, remove dust and contamination, adjust pins and components, remove residual solder and flux, cut away unnecessary circuit elements, clean or expand pad holes, and eliminate residue prior to soldering.



ETL-900-100	6-Piece Soldering Tool Set for Printed Circuit Boards	\$8.31
-------------	---	---------------

Desoldering Pumps

Choose from these models of Eclipse high-performance desoldering pumps.

ETL-DP-366J	High-Suction Transparent Desoldering Pump	\$5.29
ETL-900-004	Mini-Tip Desoldering Pump w/Anti-Static Tip	\$8.39

Helping Hand Work Holder

When confronted with a tricky job and only two free hands, many a Ham has wished they were an octopus. Well, here's a more practical solution—the Helping Hand Work Holder from ECG. This heavily weighted mini work stand features a universal joint for positioning your work, and an arm with two strong alligator clamps to hold the parts in place. For tiny projects, the stand includes a magnifier that makes minuscule parts look big. Make your time in the shack a bit easier—no tentacles required.



ECG-JA-40	Helping Hand Work Holder	\$11.99
-----------	--------------------------------	----------------

Heat Shrink End Caps

Seal the ends of wires and cables at your station the right way with these waterproof Heat Shrink End Caps. They're lined with hot melt adhesive to provide electrical insulation and resistance to chemicals and abrasion. Choose from six sizes from inside diameters of 12mm (0.472") to 75mm (2.950"). Please note that caps heat shrink by a factor of three (e.g., the 12mm shrinks to 4mm).



NTE-47-EC012	Heat Shrink End Caps, 12mm ID, Pack of 5	\$7.99
NTE-47-EC020	Heat Shrink End Caps, 20mm ID, Pack of 3	\$8.29
NTE-47-EC025	Heat Shrink End Caps, 25mm ID, Pack of 3	\$8.59
NTE-47-EC035	Heat Shrink End Caps, 35mm ID, Pack of 2	\$8.29
NTE-47-EC055	Heat Shrink End Caps, 55mm ID, Pack of 2	\$8.99
NTE-47-EC075	Heat Shrink End Caps, 75mm ID, Each	\$7.99

Soldering Stations

For improved productivity and convenience, choose a soldering station from ECG, featuring either analog or digital readout controls. These electronically pulse-powered, temperature-controlled low wattage irons bring a completely new range of professional-level soldering results to hobbyists looking for superior results. ECG Soldering Stations are corded, AC powered and include a convenient iron holder with a built-in sponge pad for easy tip cleaning. Featuring a weighted base for added stability, they're ideal for general electronic soldering and repair, connector and cable terminations, kit building and more. They're available in 50 and 75 watt standard control versions or the digital 75 watt model. The new 75 watt J-SSD-2 and J-SSD-3 (with programmable temperature storage) come with upgraded intelligent temperature control and automatic shutdown.



ECG-J-SSA-1

ECG-J-SSA-1	75 Watt Standard Temperature-Controlled Soldering Station ...	\$68.99
ECG-J-SSA-2	50 Watt Standard Temperature-Controlled Soldering Station ...	\$39.99
ECG-J-SSD-1	75 Watt Digital Temperature-Controlled Soldering Station	\$83.99
ECG-J-SSD-2	75 Watt Digital Intelligent Temperature-Controlled Soldering Station	\$109.99
ECG-J-SSD-3	75 Watt Digital Intelligent Temperature-Controlled Soldering Station, Programmable ...	\$117.99



Rechargeable Soldering Irons

ISO-TIP offers cordless soldering irons that heat up quickly, provide high operating temperatures and have a long service life. Here are some of its most popular irons.

Butane Torches

As an alternative to ISO-TIP's battery powered options, these butane soldering irons are ideal if you're doing remote field work away from a charging source. Since they can also be used for brazing, cutting, de-icing and activating heat shrink, they're a smart choice if you're climbing a tower and can't carry a bunch of tools. The kits include the iron and multiple tips for different uses.

ISO-7977



ISO-7977	Pro 120 Butane Soldering Iron Kit	\$105.99
ISO-9010*	Pro 90 Butane Soldering Iron Kit	\$61.99

*Due to shipping restrictions these torches ship without butane.

Model 7700

As ISO-TIP's flagship iron, the 7700 is a well rounded iron for shop and shack use. It can be completely recharged in 3-4 hours, and will solder up to 125 joints on a single charge. The iron comes with a handy charging stand and a pair of interchangeable tips. Model 7700 is also available in a kit that includes more tips, solder, heat shrink tubing, flux, a butane torch, cleaning pad and a handy carrying case.

ISO-7700



ISO-7700	Model 7700 Rechargeable Soldering Iron	\$72.99
----------	--	----------------

Power Pro Advanced Soldering Iron Kit

This kit makes an excellent addition to your Ham shack when you've got a lot of work to accomplish at once. Solder up to 150 joints per charge during continuous use. Kit includes soldering iron, recharging stand, LiFePO4 battery, high efficiency fine tip and chisel tip, and a one-year limited warranty. Iron fully charges in 3 to 3.5 hours for long sessions of precision work.



ISO-8000	Advanced Soldering Iron Kit	\$111.99
----------	-----------------------------------	-----------------



Adhesive Lined Heat Shrink Tubing

Insulate and protect your connections without the hassle of tape, using DX Engineering Adhesive Lined Heat Shrink Tubing. It's also perfect for repairing nicks in a cable jacket or for dressing-up your in-shack runs. Both packs include 20 individual 1.5" lengths of tubing, each with a 3:1 shrink ratio.



DXE-HS38-20	Heat Shrink Tubing, 0.375" OD	\$12.49
DXE-HS12-20	Heat Shrink Tubing, 0.500" OD	\$13.79

Summit Racing™ Shrink Sleeve Assortment

Way better than standard vinyl heat-shrink tubing (which can crack and tear), this tubing is made with professional-grade polyolefin. That helps it better withstand both time and the elements. This kit includes over sixty 6 inch tubes ranging from 1/8" to 3/4" ID, all housed in a compartmentalized case, so everything stays neat and tidy.



SUM-890092	Shrink Sleeve Assortment	\$22.99
------------	--------------------------------	----------------

Need advice? 1-330-572-3200 or DXEngineering@DXEngineering.com

ECG Heat Guns and Accessories

You wouldn't use a butter knife as a screwdriver, so don't use a hair dryer as a heat gun. With an adjustable range of 250 to 1,100 degrees F and a 2-speed motor, the HG-001VT is perfect for hobbyists. ECG also makes a Miniature Heat Gun, great for installing heat shrink tubing into tight chassis or near cramped PCBs. The Mini Heat Gun has a two-speed motor and a working temperature range of about 480 to 660 degrees F.

For more frequent use, get an Industrial Grade ECG Heat Gun. They boast an adjustable air intake, a sturdy toggle switch, replaceable motor brushes and a six-foot heavily shielded cord. The Industrial Grade guns all have a mica heating element for extra long service lives.

- ECG-HG-001VT Economy Heat Gun \$48.99
 - ECG-HG-300D Mini Economy Heat Gun \$26.99
 - ECG-HG-005 Industrial Grade Heat Gun, 500-750° F \$169.99
- Accessories**
- ECG-HG-0010 3/4" Reflector for Industrial Grade Heat Guns \$11.99
 - ECG-HG-0011 2" Reflector for Industrial Grade Heat Guns \$29.99
 - ECG-HG-0013 7/8" Heat Concentrator for Economy Heat Gun \$8.59
 - ECG-HG-0014 3/8" Heat Concentrator for Economy Heat Gun \$11.99
 - ECG-HG-0015 Shrink Tube Reflector for Economy Heat Gun \$11.49



Heat Guns

The Digital LCD Heat Gun (ETL-902-458) features digital LCD display, smart overheat protection design, automatic cool air flow to reduce cool-down time, and two temperature settings (300°C and 500°C). Includes four nozzles, scraping tool, and blow-molded case. The SS-611A model gives you all the same great features without the digital display.

- ETL-902-458 Digital LCD Heat Gun with Accessories \$89.99
- ETL-SS-611A Heat Gun with Accessories \$62.99



DX ENGINEERING

Heat Shrink Insulated Butt Connectors

Get your station projects done the right way with Heat Shrink Insulated Butt Connectors with internal fluxed solder ring. These no-crimping-required connectors feature a transparent sleeve for precise visual inspections, greater pull strength than PVC or nylon connectors, heat shrinkable tube insulation, maximum 600V rating, color-coding to industry standard wire gauges, and full waterproofing to protect against corrosion. Check out our YouTube channel for an in-depth product demo!

- DXE-HSIB-1210-10 10 Pack, 12-10 AWG \$8.99
- DXE-HSIB-1210-25 25 Pack, 12-10 AWG \$12.99
- DXE-HSIB-1210-50 50 Pack, 12-10 AWG \$24.99
- DXE-HSIB-1614-10 10 Pack, 16-14 AWG \$7.99
- DXE-HSIB-1614-25 25 Pack, 16-14 AWG \$11.99
- DXE-HSIB-1614-50 50 Pack, 16-14 AWG \$22.99
- DXE-HSIB-2218-10 10 Pack, 22-18 AWG \$6.99
- DXE-HSIB-2218-25 25 Pack, 22-18 AWG \$10.99
- DXE-HSIB-2218-50 50 Pack, 22-18 AWG \$21.99
- DXE-HSIB-2624-10 10 Pack, 26-24 AWG \$6.19
- DXE-HSIB-2624-25 25 Pack, 26-24 AWG \$10.19
- DXE-HSIB-PACK1 24 Pack, 6 Each, 12-10, 16-14, 22-18, 26-24 AWG \$9.99
- DXE-HSIB-PACK2 40 Pack, 10 Each, 12-10, 16-14, 22-18, 26-24 AWG \$13.99
- DXE-HSIB-PACK3 80 Pack, 20 Each, 12-10, 16-14, 22-18, 26-24 AWG \$21.99

Scan code to watch video.



TITAN

Electric Heat Gun

Made from durable ABS plastic, this double-insulated Titan electric heat gun (750/1,500 Watts, 110/120 V AC) delivers dependable performance for a variety of projects, including plastic welding, shrink tubing, and paint stripping. It features a dual temperature setting and three-position rocker switch (off, high, and low).

- TTN-22400 Electric Heat Gun \$20.99



Heat Shrink Sleeves

These tough, durable heat shrink sleeves are an excellent choice for sealing and insulating your cable runs. They'll work inside and outside of your shack, including in direct-burial and submersible applications.



Part Number	Diameter(s)	Length	Quantity	Color	Price
Single Sections, Thick Wall, 3:1 Shrink Ratio					
NTE-47-404013-BK	1.57"	48"	1	Black	\$31.99
NTE-47-400124-BK	1.27"	48"	1	Black	\$16.99
Assortment Packs, Thin Wall, 2:1 Shrink Ratio					
NTE-HS-ASST-1	3/32"-1/2"	6"	24	Black	\$8.59
NTE-HS-ASST-2	1/16"-1/2"	2.5"	158	Black	\$16.99
NTE-HS-ASST-3	1/16"-1/2"	2.5"	158	Red	\$17.99
NTE-HS-ASST-4	1/16"-1/2"	4"	24	Black	\$6.99
NTE-HS-ASST-5	1/8"	6"	10	Assorted	\$6.99
NTE-HS-ASST-7	1/4"	6"	10	Assorted	\$6.99
NTE-HS-ASST-8	3/8"	6"	10	Assorted	\$6.99
NTE-HS-ASST-10	1/16"	6"	10	Assorted	\$6.99
NTE-HS-ASST-11	3/32"	6"	10	Assorted	\$6.99
NTE-HS-ASST-12	1/2"	6"	10	Assorted	\$7.99

NANO Equipment Cases

Perfectly sized for smaller gear like smartphones, HTs and digital cameras, NANO Equipment Cases have the same crushproof and water resistant characteristics of NANUK's larger cases. NANO Cases are feature the exclusive PowerClaw™ latching system and are airline carry-on approved. These cases also accept a padlock and include a small wrist strap. Exterior dimensions: 7.4" L x 5.1" W x 2.6" H

- NANO Equipment Cases from \$39.95



NANUK Genuine Accessories

NANUK makes a ton of accessories for your new case. Two of the most popular are its TSA Combination Padlock and Neoprene Shoulder Strap. The padlock has a three-digit combination key and is TSA-approved. A visual indicator on the lock lets you know if the TSA inspectors opened your case. The adjustable shoulder strap features padded foam for comfort. Metal buckles contribute to the strap's durability.

- PSC-900LOCKNANUK Combination Padlock \$42.95
- PSC-900-STRAP Neoprene Strap \$60.95



DX Engineering Giant Tool Bag

What better place to store your DX Engineering tools and whatever else you're taking into the field, or keeping handy in the shack, than with a DX Engineering Giant Tool Bag. The well-built canvas bag with heavy-duty, two-way zipper enclosure has plenty of space for the tools, hardware, and fasteners you need to keep your station well maintained and on the air. The 20" x 11" x 10" water-repellant bag features a reinforced bottom, anti-skid rubber feet, and 27 pockets—21 outside and six inside.

- DXE-TOOLBAG DX Engineering Giant Tool Bag.... \$21.99



LEATHERMAN

Leatherman Multi-Tools

Co-founded by Timothy Leatherman in 1983, Leatherman is a name that has become synonymous with high-quality, multipurpose tools that can be a ham's best friend in and out of the shack. DX Engineering carries more than 30 Leatherman Multi-Tools that are designed to perform a range of tasks. Built to last, Leatherman tools are backed by a 25-year limited manufacturer's warranty. Enter "LMT" at DXEngineering.com for the full lineup.



- Wave + Multi-Tool**
- This international best-seller from Leatherman features 18 stainless steel tools to conveniently handle lots of jobs at home or in the field. The Wave + includes flathead and Phillips screwdrivers, file, knife, hex drive, pliers, saw, spring-action scissors, bottle opener, can opener, wire cutter, wire stripper, ruler, serrated blade, electrical crimper, and more. Black nylon sheath also included.
- LMT-832531 Wave + Multi-Tool..... \$119.95
- Free P4 Multi-Tool**
- This unique, 21-tool all-in-one multi-tasker can handle a heavy list of chores but weighs only 8.6 ounces and measures a mere 4.25" when closed. It's got many of the stainless steel tools packed into the Wave + with the addition of an awl, package opener, and pry tool. Gray nylon sheath also included.
- LMT-832640 Free P4 Multi-Tool..... \$149.95
- Free K4 Multi-Tool**
- This stainless steel 9-tool workhorse features a knife with 3.3" blade, awl, bottle opener, flathead and Phillips screwdrivers, package opener, pry tool, and spring-action scissors.
- LMT-832664 Free K4 Multi-Tool..... \$99.95

We're All Elmers Here! Get Expert Support at: Elmer@DXEngineering.com



NANUK Equipment Cases

From arctic blasts to scorching desert heat, NANUK Equipment Cases have been tested and proven in the harshest environments on the planet. They're designed to meet strict military standards and are virtually indestructible. Each one is made from NANUK's exclusive high-impact resin, which means they're extraordinarily strong yet lightweight. A hollow core gasket makes the cases watertight and PowerClaw™ latches ensure the lids stay closed. They also have built in flanges to accept a padlock. NANUK stands behind all of its cases with a lifetime guarantee.

NANUK Equipment Cases come in a wide range, sizes and colors (red and blue options are now available). Each one listed below is filled with cubed foam that you can easily pull away to create a custom foam recess for your gear. Most cases are also available empty and a padded foam divider is sold separately to give you more storage options. Additional case sizes, custom foam and accessories are available at DXEngineering.com.

Part Number	Color	Price
905 Series Cases, with foam Ext. Dimensions: 12.5" L x 10.1" W x 6" H		
PSC-905-1001	Black	\$83.95
PSC-905-1002	Lime	\$83.95
PSC-905-1003	Orange	\$83.95
PSC-905-1004	Yellow	\$83.95
PSC-905-1005	Silver	\$83.95
PSC-905-1006	Olive	\$83.95
PSC-905-1007	Graphite	\$83.95
PSC-905-1008	Blue	\$83.95
PSC-905-1009	Red	\$83.95
910 Series Cases, with foam Ext. Dimensions: 14.3" L x 11.1" W x 4.7" H		
PSC-910-1000	Tan	\$84.95
PSC-910-1001	Black	\$84.95
PSC-910-1002	Lime	\$84.95
PSC-910-1003	Orange	\$84.95
PSC-910-1004	Yellow	\$84.95
PSC-910-1005	Silver	\$84.95
PSC-910-1006	Olive	\$84.95
PSC-910-1007	Graphite	\$84.95
PSC-910-1008	Blue	\$84.95
PSC-910-1009	Red	\$84.95
935 Series Wheeled Cases, with foam Ext. Dimensions: 22" L x 14" W x 9" H		
PSC-935-1001	Black	\$249.95
PSC-935-1003	Orange	\$249.95
PSC-935-1004	Yellow	\$249.95
PSC-935-1005	Silver	\$249.95
PSC-935-1006	Olive	\$249.95
PSC-935-1007	Graphite	\$249.95
PSC-935-1008	Blue	\$249.95
PSC-935-1008	Red	\$249.95
960 Series Wheeled Cases, with foam Ext. Dimensions: 25.4" L x 20" W x 14.5" H		
PSC-960-1001	Black	\$435.95
PSC-960-1003	Orange	\$435.95
PSC-960-1004	Yellow	\$435.95
PSC-960-1007	Graphite	\$435.95

DX ENGINEERING



Partsbox Storage Cabinets and Part Totes

If you've got DX Engineering Partsbox Storage Cases scattered about your shack, now there's a sure-fire way to keep them together. Just slide the cases into a sturdy DX Engineering Partsbox Storage Cabinet to stay organized and enjoy quick access to the parts you need. Each stackable cabinet is 15-1/2" W x 16" H x 14-1/2" D. Drawers hold each Partsbox Storage Case snugly and slide out 10 inches. The Crimp Style Connector Partsbox and Anderson PowerPoles Connector Partsbox sold separately. Made from strong, durable plastic, Summit Racing Part Totes (8" L x 7" W" x 5.25" H) are a convenient way to carry around a small set of tools and/or components like connectors and fasteners wherever your ham radio pursuits take you.

- DXE-CAB-WBOXES Cabinet with 5 Trays/ 5 Empty Storage Boxes **\$165.99**
- DXE-PARTSBOX-1 Partsbox Storage Box Only, Clear, Single Empty **\$27.99**

- Partsbox Storage Case Kits**
- DXE-COAXBOX-C1 Partsbox w/Assortment of Crimp Style Coaxial Connectors..... **\$131.94**
- DXE-POWERBOX-C1 Partsbox w/Assortment of PowerPole Connectors..... **\$138.39**

- Part Totes**
- SUM-G1240BLK Part Tote, Black..... **\$11.99**
- SUM-G1240BLU Part Tote, Blue **\$11.99**
- SUM-G1240RED Part Tote, Red **\$13.99**

plasticase NANUK PROFESSIONAL PROTECTIVE CASES

First Aid Logo Cases

These red equipment cases come in various sizes and feature a prominent first aid logo in white, plus all the ruggedness and durability you've come to expect from NANUK. Cases do not include foam insert. They're perfect for keeping medical and emergency supplies safe and secure during Field Day or any portable operation.



- PSC-903-FSA9 First Aid Case, Series 903, 9.1" L x 6.8" W x 3.8" H..... **\$40.99**
- PSC-904-FSA9 First Aid Case, Series 904, 10.2" L x 7.9" W x 4.5" H..... **\$49.95**
- PSC-905-FSA9 First Aid Case, Series 905, 12.5" L x 10.1" W x 6.0" H..... **\$65.99**
- PSC-908-FSA9 First Aid Case, Series 908, 12.5" L x 9.8" W x 8.0" H..... **\$78.99**
- PSC-909-FSA9 First Aid Case, Series 909, 11.64" L x 9.0" W x 4.38" H..... **\$61.99**
- PSC-910-FSA9 First Aid Case, Series 910, 14.3" L x 11.1" W x 4.7" H..... **\$77.99**
- PSC-915-FSA9 First Aid Case, Series 915, 15.8" L x 12.1" W x 6.8" H..... **\$111.99**
- PSC-920-FSA9 First Aid Case, Series 920, 16.7" L x 13.4" W x 6.8" H..... **\$249.95**
- PSC-935-FSA9 First Aid Case, Series 935, Wheeled, 22" L x 14" W x 9" H; **\$215.95**

GATOR Cases



GCI-G-PRO-6U-19



GCI-GR-4L

Equipment Rack Cases

Made from rotationally-molded polyethylene (Pro Series) or lightweight molded polyethylene (Standard Series), virtually indestructible Equipment Rack Cases from Gator are ideal for housing radios, power supplies, antenna tuners and more. They feature recessed steel "butterfly" twist latches that keep the removable front and rear lids secure, non-slip rubber feet, ergonomic side handles, and included rails and screws. Cases are available in rack heights of four or six units. Choose from rack depths of 14.25" or 19". For equipment and accessories not built for rack mounting, DX Engineering also carries steel vented rack panels, steel rack utility shelves, and screw sets. Pro Series cases are available with wheels by special order.

- GCI-G-PRO-4U-19 Pro Series Rack Case, 4 Units, 19" Depth **\$199.99**
- GCI-G-PRO-6U-19 Pro Series Rack Case, 6 Units, 19" Depth **\$249.99**
- GCI-GR-4L Standard Series Rack Case, 4 Units, 19" Depth **\$259.99**
- GCI-GR-4S Standard Series Rack Case, 4 Units, 14.25" Depth..... **\$239.99**
- GCI-GR-6L Standard Series Rack Case, 6 Units, 19" Depth **\$279.99**
- GCI-GR-6S Standard Series Rack Case, 6 Units, 14.25" Depth..... **\$249.99**

Utility Shelves and Panels

- GCI-GRW-PNLVNT1 Flanged Vent Rack Panel, 1 Unit..... **\$17.99**
- GCI-GRW-SHELF1 Utility Shelf, 1 Unit 10" Deep... **\$59.99**
- GCI-GRWSHELFVNT1 Utility Shelf, 1 Unit 15" Deep, Vented **\$79.99**

Rack Screw Sets

- GCI-GRW-SCRW025 Rack Screws, #10-32 x 3/4", Pack of 25 **\$7.99**
- GCI-GRW-SCRW050 Rack Screws, #10-32 x 3/4", Pack of 50..... **\$19.99**
- GCI-GRW-SCRW100 Rack Screws, #10-32 x 3/4", Pack of 100 **\$34.99**

Milwaukee



PACKOUT Organizers

Milwaukee PACKOUT organizers are durable and versatile. They are constructed with impact-resistant materials to withstand harsh jobsite environments, and are IP65 rated to protect your tools, accessories, and small parts from rain and other jobsite debris. Available with different internal configurations, all models feature removable storage bins and transparent lids that seal the organizers to prevent contents from migrating and shifting during transport, as well as to also allow quick and easy identification of contents. They are equipped with heavy-duty latches and reinforced hinges to ensure the contents stay contained and protected. Milwaukee's PACKOUT modular organizers allow you to customize and build your own storage system to easily transport and arrange your tools and accessories.

PACKOUT Organizersfrom **\$29.97**

Visit DXEngineering.com for the latest limited-time offers and special savings!



Penetrox™ A Electrical Joint Compound

Use Penetrox A Electrical Joint Compound to ensure a proper electrical connection between your aluminum and copper metal parts. This stuff works great on conductors, telescoping aluminum tubing, or other antenna and grounding components. Penetrox A Electrical Joint Compound ensures high conductivity at all voltage levels by preventing corrosion and oxidation. It is perfect for all aluminum-to-aluminum, aluminum-to-copper tubing or bare conductor connections; you should not use this on rubber or polyethylene insulated wire.

- DXE-P8A Penetrox A Electrical Joint Compound, 8 Oz. Bottle**\$22.99**
- DXE-PENA-1-2 Penetrox A Electrical Joint Compound, 1/2 Oz. Tube.....**\$6.79**



Anti-Seize Lubricant



Anti-Seize Lubricant is absolutely critical for tower and antenna building, and it's also important for assembling chassis. It can prevent galling, corrosion and seizing, which means your parts will come apart easily, even if they've been outside for years.

- PTX-81343 Anti-Seize Lubricant, 1 Oz. Tube**\$3.09**
- PTX-80071 Anti-Seize Lubricant, 4 Oz. Brush-Top Bottle.....**\$6.99**

Hazardous, limited to domestic UPS Ground shipping only.



Dielectric Grease



Isolate precision electrical connections and seal out moisture. There are hundreds of uses for Dielectric grease, ranging from coax connectors and spark plug boots to bulb sockets and panel feed-throughs.

- PTX-22058 Dielectric Grease, 3 Oz. Tube**\$8.99**

Hazardous, limited to domestic UPS Ground shipping only.



Dielectric Grease



Put this on your connectors to ensure moisture stays out and your continuity remains consistent. Dielectric grease will also keep your connectors from corroding and seizing, making them easier to separate, when the time comes.

- LCT-37534 Dielectric Grease, 0.33 Oz. Tube**\$4.99**



RTV Silicone



Ensure your equipment stays watertight, but be careful: ordinary silicone shouldn't be used on aluminum. Instead use Ultra Black, it's safe for use on aluminum and can withstand temperatures up to 500 degrees F.

General-purpose clear silicone is a great way to seal up plastic housings and enclosures. Put a little dab in your bolt and screw recesses to keep rainwater out, too!

- PTX-82180 Ultra Black RTV Silicone, 3.35 Oz. Tube**\$5.89**
- PTX-80050 Clear RTV Silicone, 3 Oz. Tube**\$4.99**

Hazardous, limited to domestic UPS Ground shipping only.



Jet-Lube® SS-30™

An absolute must-have when making metal-to-metal connections on outdoor gear. Jet-Lube SS-30 Pure Copper is both an anti-seize lubricant and a conductive termination compound. That means it will prevent galling and create a more reliable electrical connection.

- JTL-12555 0.25 Lb. Brush-Top Can.....**\$31.99**
- JTL-12502 0.50 Lb. Brush-Top Can.....**\$42.99**
- JTL-12504 1.00 Lb. Brush-Top Can**\$64.99**



Electrical Moisture Sealing Tape



Good up to 600 volts, use this tape to make your outdoor cables and connections watertight. It can also cover your terminals and works well for general household electrical connections, like floodlights and lampposts. The tape is self-fusing and resistant to UV rays and corrosion. It is sold in 2.5" by 10' rolls, or in handy 2.5" x 2.5" square pads.

- TES-06147 Electrical Moisture Sealant Tape, 10' Roll.....**\$36.99**
- TES-06149 Electrical Moisture Sealant Pads, Box of 25.....**\$20.99**



Scotch® Super 88 Premium Vinyl Electrical Tape

Thicker and stronger than most vinyl electrical tapes, Super 88 is an excellent way to keep moisture out of your connectors. It insulates up to 600 volts and is resistant to sunlight, moisture, corrosion and chemicals. Plus, it's designed to perform well in temperatures from 0-220°F (-18-105°C).

- TES-06143 Premium Vinyl Electrical Tape; **\$11.99**



3M Scotch® Super 33+ Vinyl Electrical Tape

Scotch Super 33+ is highly conformable and stretchable, making it suitable for all weather applications. The tape combines PVC backing with excellent electrical insulation (up to 600V) to provide protective jacketing for cable splices. It is recommended as a protective overwrap for 3M Temflex™ Rubber Splicing Tape when used for RF connector weatherproofing.

- TES-7100201470 Vinyl Electrical Tape**\$10.99**



3M Temflex™ 2155 Rubber Splicing Tape

3M Temflex 2155 Rubber Splicing Tape is a conformable, self-fusing rubber electrical insulating tape. Designed for low voltage electrical insulating and moisture sealing applications, the rubber-based tape is capable of operating in temperatures up to 80 degrees C. It is compatible with synthetic cable and wire insulations, and is not corrosive to aluminum or copper conductors. For outdoor use, the tape should be protected from UV deterioration with an overwrap of Scotch Super 33+ Vinyl Electrical Tape.

- TES-2155 Rubber Splicing Tape.....**\$8.99**



DX ENGINEERING Never-Seez®

- Prevents galling and galvanic corrosion
- Protects metal parts against rust, corrosion and seizure

- DXE-NSBT8 Never-Seez, 8 Oz. Brush Top.....**\$19.99**
- DXE-NMCBT8 Never-Seez, Marine Grade, 8 Oz. Brush Top.....**\$26.99**

Hazardous, limited to domestic UPS Ground shipping only.



CAIG DeoxIT® D5 Contact Cleaner

DeoxIT D5 has become synonymous with electrical cleaning solutions, and for good reason. When sprayed on an electrical contact, it dissolves oxidation and corrosion to improve conductivity. The solution fills in microscopic gaps, essentially resealing the original metal. That makes DeoxIT D5 ideal for connectors, relays, bulb/fuse receptacles, pots, cartridge slots, etc. In RF applications, DeoxIT D5 has been shown to reduce arcing, RFI and connector wear. It's safe for plastics and dries without a residue. With adjustable L/M/H valve. CAG-D5S-6-LMH DeoxIT® D5 Contact Cleaner.....**\$23.99**



CAIG DeoxIT® Cleaning Solutions from CAIG Laboratories

Regular care and maintenance of sensitive electronic gear is a crucial part of station performance. Cleaning products from CAIG Laboratories are specially formulated to be safe and effective on precision telecommunications equipment. They can rejuvenate old gear, making your audio clearer, signal stronger and your station more reliable.

DeoxIT® Gold G5 Spray
It's formulated specifically for gold-plated connectors, but works equally well on silver, brass and copper.

- CAG-G5S-6 DeoxIT Gold G5 Spray**\$34.99**

DeoxIT® DN5 Spray
This non-flammable contact cleaner spray dries quickly and won't drip, perfect for use around heat or on a crowded PCB.

- CAG-DN5S-6N DeoxIT DN5 Spray**\$38.99**

DeoxIT® D100 Spray
D100 is pure, 100% DeoxIT Cleaner for areas that need maximum lubrication. To reduce overspray, the can has a metered one-shot dispenser.

- CAG-D100S-2 DeoxIT D100 Spray.....**\$27.99**

DeoxIT® Screen Cleaner
Don't use harmful ammonia-based window cleaner on your electronic displays and screens, use this. It comes with a microfibre cloth.

- CAG-CCS-503 DeoxIT Screen Cleaner.....**\$16.99**

DeoxIT® Cleaning Kits

CAIG bundled together some of its most popular cleaners into handy kits. They're ideal for tossing in a Go-Kit or your glove box. If your club has an EMCOMM trailer, it's not a bad idea to stuff a kit in there, too.

DeoxIT® Emergency Survival Kit
This kit comes with the DN5 Spray, a D100 Pen, a D100 Squeeze Tube, plus three D1W wipes. It's handy if you need to recondition your HT or flashlight in an emergency.

- CAG-K-DEO-ESK DeoxIT Emergency Kit**\$34.99**

DeoxIT® Audio/Video Survival Kit
Do you have an aging home theater system? This kit will help you keep it in tip-top shape. It includes an assortment of cleaner sprays, swabs, brushes and wipes.

- CAG-SK-AV35 DeoxIT Audio/Video Survival Kit.....**\$52.99**



Visit DXEngineering.com for the latest limited-time offers and special savings!

DX ENGINEERING

Silver/PTFE Coax Connectors

This superior solder-on PL-259 connector uses silver plated outer and inner conductors and a PTFE insulator. The connector has very low loss and high electrical breakdown. It fits directly on RG-8, RG-213, 9913 and other cables with a nominal .405 inch OD jacket size.

Use a DXE-UG175 reducer with this connector to fit RG-58A/U and/or LMR195 coax, and a DXE-UG176S-6 reducer to fit RG-8X coax.

- DXE-PL259-6 PL-259 Connector, Pack of 6.....\$36.99
- DXE-UG176S-6 RG-8X Reducer for PL-259, Silver Plated, Pack of 6.....\$13.29
- DXE-UG175S-6 RG-58 Reducer for PL-259, Silver Plated, Pack of 6.....\$11.99

Amphenol® RF

PL-259 Connector

This PL-259 from Amphenol RF is a solder-on connector sized precisely for 50 Ω RG-8, RG-9, RG-213 and RG-225 coaxial cable. It's tailored to 0-300 MHz and will handle 500 volts (peak).

- AML-83-1SP-6 PL-259 Connector, Pack of 6.....\$44.99

Coax Cable Cutters

These high-quality cable cutters have blades designed to cut coaxial cable cleanly. They will not crush the cable like diagonal side cutters—the cut end of the cable is cleanly cut, ready for stripping and connector assembly. The cutters can handle aluminum up to 4/0-gauge and soft copper cable up to 2/0-gauge.

- CNL-911 Coax Cable Cutters.....\$29.99

DX ENGINEERING

E-Series Three-Level Coax Cable Stripper

Molded from high-impact plastic, this stripper is simple to use and delivers a professional, repeatable prep job every time. It features an adjustable blade that is easy to replace. No special cartridge necessary. It's designed for stripping RG-8, RG-11, RG-213, and similar size cables in the 0.405" diameter range.

- DXE-15035-C Stripper for RG-8, RG-11, RG-213.....\$7.99

DX ENGINEERING

Precision Shear Side Cutters

These DX Engineering Precision Shear Side Cutters are the perfect tool for trimming loose strands of copper braid, trimming individual strands of the center conductor.

- Low-profile, general purpose cutter
 - Superior blade bypass shear cutting action
 - Better cuts with half the effort
 - Reduced mechanical shock delivered to the work
 - Flush cuts soft wire up to 20 AWG (0.8mm)
- DXE-170M Precision Shear Side Cutters.....\$12.59



DX ENGINEERING

Coax Cable Strippers for 50 Ω Cable

These DX Engineering strippers prepare 50 Ω coax cable for installation of a solder-on PL-259 connector.

- Work on foam or solid dielectric cable
 - Precision, two-step operation
 - No nicks or scratches to conductor
 - Premium, long-lasting cutter blades
- DXE-UT-8213 Coax Cable Stripper for RG-8, RG-213, 9913 and Similar Size Cable, Red.....\$72.99
 - DXE-UT-808X Coax Cable Stripper for RG-8X and Belden 9258 Cable, Green.....\$87.99
 - DXE-UT-8213LR Coax Cable Stripper for RG-213, RG-8 and Similar Size Cable, Purple.....\$100.99
 - DXE-UT-RB-HD* Pack of Two Heavy-Duty Replacement Blades for UT-8 Tools.....\$29.49

*Also fits Cablematic UT-8000

DX ENGINEERING



DXE-CGH-8X



DXE-CGH-8U

Cable Grippers

These hand grippers are the perfect complement to DX Engineering's Coaxial Cable Prep Tools. They help you securely hold your cable while you're doing the proper prep. They're also effective for holding the cable as you're pulling it off a spool or out of a box for a run. These grippers have been redesigned to incorporate a hinge between the two halves. This makes it easier to store and manipulate the grippers.

- DXE-CGH-8U Cable Gripper for RG-8U Size Cable, Red.....\$19.99
- DXE-CGH-8X Cable Gripper for RG-8X Size Cable, Green.....\$19.99



Long Reach Pliers

This handy tool is perfect for installing and removing connectors in hard-to-reach places and on crowded panels. The vinyl covered jaws are well suited to both Type N and PL-259 connectors, while the no-slip grip gives you plenty of leverage. Use these pliers and you'll avoid cramped hands and fatigued fingers. Color may vary.

- SUM-900071 Long Reach Pliers.....\$10.99



SO-239 Connector Installation Tool Kit

This versatile tool kit will help you install chassis or bulkhead mount SO-239 coax connectors. It includes a special stainless steel wrench. One end has a 3/4 inch semi-box wrench with a pass-through for coaxial cable—perfect for tightening the large nut used to mount bulkhead connectors. The other end is a 3/16 inch box wrench for tightening mounting nuts with SO-239 hardware. Also included is a multi-purpose 6-in-1 screwdriver/nutdriver tool with the following bits:

- 1/4 inch nutdriver
 - 5/16 inch nutdriver
 - 1/4 inch flathead
 - #1 Phillips
 - 3/16 inch flathead
 - #2 Phillips
- DXE-T001 SO-239 Connector Installation Tool Kit.....\$27.99



DXE-UT-KIT4

DX ENGINEERING

Coaxial Cable Tool Kits

Carry everything you need to prep and install soldered connectors on your coaxial cable. The Basic Kit is tailored for RG-213 and RG-8 cable with PL-259 connectors. It includes a stripping tool, gripping tool, specialized PL-259 assembly tool, cable shears and a carrying case.

Upgrading to the Complete Kit gives you the tools to work with RG-8/X size cable and Type N connectors. It comes with specialized stripping, gripping and assembly tools. You'll also get a braid trimmer and replacement blades for the stripping tool.

If you've been using your tool case a lot and the foam is starting to disintegrate, DX Engineering now offers replacement foam.

- DXE-UT-KIT3 Basic Coax Tool Kit.....\$181.99
- DXE-UT-KIT4 Complete Coax Tool Kit.....\$309.99
- DXE-UT-CASE-FOAM Replacement Foam for the Basic/Complete Case.....\$31.99

DX ENGINEERING



DXE-8X-PREP-P

Coaxial Cable Prep Tool Combos

These combos make working with coaxial cable much easier. They include one of our Coaxial Cable Grippers and a perfectly matched Coaxial Cable Stripper. For solder-on PL-259 connectors.

- DXE-8X-PREP-P Prep Tool Combo, for RG-8X and Similar-Size Cable.....\$107.98
- DXE-8U-PREP-P Prep Tool Combo, for RG-8U and Similar-Size Cable.....\$92.98

DX ENGINEERING

Connector Assembly Tools

These assembly tools allow simple threading of connector bodies onto the vinyl jacket of RG-8/U, RG-213/U and other similar size cables. The DXE-UT-80P assembly tool is for PL-259 connectors, and the DXE-UT-80N assembly is for two-piece Type N connectors. Assembly is simple. Strip the cable with the DXE-UT-8213 Cable Stripping Tool, then use the appropriate connector assembly tool and thread the connector body onto the stripped cable end. A visual guide at the end of the tools allows easy viewing of the cable center conductor for proper depth. You get a perfect and easy connector installation every time.

- DXE-UT-80P Connector Assembly Tool for PL-259 Connectors, Black...\$38.99
- DXE-UT-80N Connector Assembly Tool for 2-piece Type N Connectors, Blue.....\$33.99



Prices are subject to change without notice.



Coaxial Cable Prep Tools for Crimp Connectors

Tools to easily and properly prepare your coaxial cable for a DX Engineering or Amphenol Connex crimp connector and to ensure optimal station performance. Available for many cable types.

Just place the end of your coax against the internal stop, close the cutter and twist. Cable is cut to the correct measurement. Place the coax in the other side of the cutter, close it and withdraw the cable—your coax jacket is now slit for easy removal of the cut portions. Select from a complete kit, or buy each cutter separately.

Part Number	Cable Type	Connector Type	Price
DXE-UT-240C-N1	8X (0.242" OD)	Type-N and BNC	\$44.49
DXE-UT-240C-P1	8X (0.242" OD)	PL-259	\$44.49
DXE-UT-405C-N1	8U/400 (0.405" OD)	Type-N and BNC	\$44.99
DXE-UT-405C-P1	8U/400 (0.405" OD)	PL-259	\$44.99
DXE-UT-KIT-CC1	Complete Kit with Tools Above and Case		\$301.99



DX ENGINEERING Ultra-Grip 2 Crimp Connector Hand Tool Kit

This kit includes everything you need to make professional-quality crimps on coaxial and Powerpole® connectors. The ratcheting steel crimper is designed to fit ergonomically in your hand to reduce fatigue. The kit comes with the Ultra-Grip 2 Tool, 5 crimp dies, shears, braid trimmer, Allen wrench and case. You get crimp dies precisely sized for RG-8U, LMR-400, RG-8X and LMR-240 type cables, along with specialized dies for Powerpole 15A, 30A and 45A connectors, as well as insulated and un-insulated wire terminals.

The Ultra-Grip 2 Crimp Tool, interchangeable dies and specialized carrying case are also available separately. You can expand the functionality of your UT-CRIMP and UT-CRMP2 Crimp Tool with extra crimp dies. They're made to handle various common crimp connector types in several sizes.

DXE-UT-KIT-CRMP2	Complete Kit, 5 Die Sets.....	\$211.99
DXE-UT-CRMP2	Crimp Tool for RG-8U/ LMR-400 Size Cable	\$72.98
DXE-UT-CRMP2-8X	Crimp Tool for RG-8X/ LMR-240 Size Cable	\$71.98
DXE-UT-CRMP2-PWR	Crimp Tool for Powerpole® 15, 30, 45A.....	\$67.98
DXE-UT-DIE-INS	Crimp Die for Insulated 22-10 AWG Terminals	\$25.99
DXE-UT-DIE-UNIS	Crimp Die for Uninsulated 22-8 AWG Terminals	\$25.99
DXE-UT-LGFRM-HP	Hardware Pack for Crimp Tool (2 bolts)	\$6.99

Next Generation Crimp/Solder UHF Male Connectors

Taking a "better mousetrap" approach, DX Engineering designed a revolutionary patented Next Generation PL-259 connector. It combines the best qualities of solder and crimp technologies for unparalleled reliability and the lowest loss. The crimp shield provides a 360° electro-mechanical connection, while the hand-soldered center pin ensures superior RF continuity. The connector features a silver-plated shell, body and center pin. A double-knurled body surface makes the PL-259 easier to install, too. It's a must-have crimp-style PL-259 for any coaxial cable, especially coax cables that use foil shields.

These are the same connectors found on all DX Engineering pre-made cable assemblies equipped with a PL-259; Essential for the lowest-loss connection possible.

Part Number	For Cable Type	Quantity	Price
DXE-PL259CS8U-6	RG-8U, LMR-400	6	\$32.99
DXE-PL259CS8U-12	RG-8U, LMR-400	12	\$55.99
DXE-PL259CS8U-24	RG-8U, LMR-400	24	\$105.99
DXE-PL259CS8X-6	RG-8X, LMR-240	6	\$33.99
DXE-PL259CS8X-12	RG-8X, LMR-240	12	\$58.99
DXE-PL259CS8X-24	RG-8X, LMR-240	24	\$109.99

DX ENGINEERING



Connectors and Adapters

Before you buy new gear, make sure you have the right adapters to install it. Amphenol RF makes must-have connector solutions. Spend less time building cable and more time on the air.

Part Number	Connector End 1	Connector End 2	Design	Price
AML-112533-4†	BNC Male	RG-8X, LMR-240	Straight	\$12.99
AML-000-2900	BNC Male	SO-239	Straight	\$33.99
AML-31-28	BNC Female	PL-259	Straight	\$37.99
AML-31-4427-2*	BNC Male	Crimp	For RG-142, -400	\$32.99
AML-000-4400	Type N Male	SO-239	Straight	\$31.59
AML-83-877	PL-259	PL-259	Barrel	\$49.99
AML-172123-2*	Type N Female	Type N Female	Straight	\$29.99
AML-172102-2*	Type N Male	Crimp	For RG-213, -8, -393	\$19.99
AML-83-1J-2*	SO-239	SO-239	Barrel	\$37.99
AML-83-1R-2*	Solder Terminal	SO-239	Chassis Mount	\$16.99
AML-83-798-2*	Solder Terminal	SO-239	Chassis Mount	\$28.99
AML-83878RFX-2*	Solder Terminal	SO-239	Bulkhead	\$17.99
AML-83-1T	PL-259	SO-239 (x 2)	Tee	\$28.99
AML-83-1AP-2*	PL-259	SO-239	Right Angle	\$46.99
AML-082-97RFX-2*	Type N Female	4-Hole Flange	Chassis Mount	\$19.99

*Sold in a package of two † Sold in a package of four

Amphenol® RF



Amphenol® Connex

Solderless Crimp-On Connectors AML-172102H-2
DX Engineering carries Amphenol Connex connectors to ensure your gear is operating at its full potential. Depending on the type, these crimp connectors feature nickel or silver plated bodies, gold or silver plated center pins and PTFE, or phenolic insulators. You can also find the proper crimping/stripping tools at DXEngineering.com.

Part Number	Connector	Fits Cable	Price
AML-112116-4	BNC Male Four Pack	RG-58, LMR-195	\$12.99
AML-172100-2	Type N Male Two Pack	RG-58, LMR-195	\$15.99
AML-172135-2	Type N Male Two Pack	RG-8X, LMR-240	\$15.59
AML-172102H-2	Type N Male Two Pack	DXE-8U 400MAX, LMR-400	\$23.99
AML-182100-4	UHF Male Four Pack	RG-58, LMR-200	\$20.99
AML-182102-4	UHF Male Four Pack	RG-213, RG-8, RG-393	\$26.99
AML-18211510-4	UHF Male Four Pack	RG-8X, LMR-240	\$39.99
AML-18213010-4	UHF Male Four Pack	DXE-8U, DXE-400MAX, LMR-400	\$45.99

Our catalog is only the beginning! See thousands of products at DXEngineering.com

DX ENGINEERING
SECUREMOUNT™



Silver Plated Female SecureMount™ Bulkhead Connector Kit

From broken continuity to an impedance mismatch, a faulty bulkhead connector can introduce several problems into your station. To solve these issues, DX Engineering has designed a 50 Ω bulkhead SO-239 connector that is leaps-and-bounds better than ordinary varieties. For starters, it's silver plated to promote excellent RF continuity. Plus, this connector has a solid PTFE dielectric at its midpoint, which helps maintain consistent impedance and connectivity. It handles frequencies from DC to 500 MHz.

The connector is an excellent complement to DX Engineering's patented Radial Plate, and many other bulkhead-mount applications. Sold as a kit, the connector includes a set of four stainless steel bolts, nylon locking nuts, star washers and flat washers.

DXE-UHF-FDFB-KIT SecureMount Bulkhead SO-239 Connector Kit**\$17.48**

Amphenol® RF

Chassis Mount Coaxial Connector Kits

Make sure your connections are sturdy and reliable. Amphenol RF makes kits that combine the connector, plus the corresponding washers, nuts and bolts you need to complete a proper installation.

AML-83-798-2-KIT SO-239 Chassis Mount Kit, PTFE Dielectric, Pack of 2**\$38.97**
AML-83-1R-2-KIT SO-239 Chassis Mount Kit, PBT Dielectric, Pack of 2**\$26.97**



Amphenol® RF

RF SMA Coaxial Cable Assemblies

Amphenol RF SMA Coaxial Cable Assemblies make it easy to connect devices that have SMA female connectors. These high-quality 50 Ω, 36" SMA male, RG-316/U jumper cables may also be used with various SMA adapters for other RF device interconnections. Order a couple and have a spare on hand!

AML-135101-03 RF SMA RG-316, 50 Ω Jumper Cable**\$34.99**



COMET™

Adapter Cables

Get your gear up and running quickly. These RG-188 adapter cables let you connect various types of equipment and antennas without significant insertion loss. Find more adapters at DXEngineering.com.



Part Number	Connector 1	Connector 2	Length	Price
CMA-HB-05	SMA Male	BNC Female	18"	\$14.99
CMA-HM-05	BNC Male	SO-239	18"	\$14.99
CMA-HM-05JSJ	SMA Female	SO-239	18"	\$15.99
CMA-HS-05	SMA Male	SO-239	18"	\$14.99
CMA-HS-10	SMA Male	SO-239	39"	\$17.99

DX ENGINEERING
Female Bulkhead Connectors

These high-quality bulkhead connectors use silver plated outer and inner conductors and a PTFE insulator. The connectors have very low-loss and high electrical breakdown. They come with two nuts to secure the connector to our Radial Plate or other flat surface. The connectors ensure the radial ground system, the antenna ground and the feedline shield are common. They can also be used for joining two pieces of coax with male PL-259s together.

DXE-363-SST Dual SO-239 Bulkhead Connector with SO-239 Socket**\$11.99**
DXE-363-SST-NI Bulkhead-style, SO-239 to SO-239, Gold Center**\$10.99**



DXE-SO239D-1 DXE-SO239BKT-1

Connectors and Mounting Solutions

If you're building your own gear or do repair work, then you've probably had to install a lot of SO-239 connectors. DX Engineering carries several Amphenol and non-Amphenol brand SO-239 chassis mount options. The connectors come with the correct bolts, flat washers, star washers and Nylok locking nuts. These are a perfect fit for the DX Engineering Radial Plate.

The DX Engineering SO-239 Mounting Bracket lets you install an SO-239 practically anywhere. It's a great match for the DXE-SO239D-1 connector. The connector also works well in any hole-mount/chassis-mount location.

The DX Engineering Installation Tool Kit is an excellent way to speed up jobs and reduce hand fatigue.

DXE-112-KIT SO-239 with Silver Plating and PTFE Insulation**\$16.99**
DXE-VC-0612 Black Vinyl Cap for SO-239, Pack of 20**\$12.99**
DXE-SO239BKT-1 SO-239 Mounting Bracket**\$7.49**
DXE-SO239D-1 SO-239 Chassis Mt. Connector.... **\$7.49**

DIAMOND ANTENNA

Antenna Adapter Cable

Make quick, in-shack hookups easier. This 4 foot cable has a male SMA connector on one end and a SO-239 connector on the other. This cable is perfect for hooking up a scanner or your HT.

DMN-C104SMA Adapter Cable**\$16.99**



DX ENGINEERING

SMA Plug and Jack Coaxial RF Connector Adapters

New!



These precision-constructed coaxial RF connector adapters deliver the long-lasting, reliable performance hams have come to expect from DX Engineering branded station accessories.

DXE-1903-1703-2 Straight, SMA Male to PL-259, Pair**\$15.99**
DXE-1903-1704-2 Straight, SMA Male to SO-239, Pair**\$15.99**
DXE-1905-1703-2 Straight, SMA Female to PL-259, Pair**\$15.99**
DXE-1905-1704-2 Straight, SMA Female to SO-239, Pair**\$15.99**



DX ENGINEERING
Coaxial Connector Adapters

DX Engineering has a selection of adapters for connecting cables with different type connectors. DX Engineering has designed and built no-compromise adapters to ensure your station isn't hampered with signal loss. Find more online at DXEngineering.com.

Part Number	Adapter Type	Qty	Price
DXE-18101815RA-2	F-Type Male to F-Type Female	2	\$7.99
DXE-CA716M-SO239	7/16 DIN Male to SO-239	1	\$63.99
DXE-SS1701801-2	PL-259 to F Female	2	\$9.59
DXE-532-2	UHF Right Angle	2	\$24.99
DXE-533-2	UHF Tee, 1 PL-259, 2 SO-239	2	\$30.99
DXE-534	UHF Tee, Triple SO-239	1	\$14.99
DXE-536-4	UHF Female Barrel	4	\$24.99
DXE-538-2	UHF Double Male	2	\$16.99
DXE-545-2	UHF Female to BNC Female	2	\$24.99
DXE-621-2	Mini UHF Male to UHF Fem	2	\$21.99
DXE-626-2	Mini UHF Female to PL-259	2	\$29.99
DXE-1011-1	N Tee, All Female	1	\$23.99
DXE-1012-1-2	N Right Angle	2	\$44.99
DXE-1013-1-2	N Double Female Barrel	2	\$28.99
DXE-1035-1-2	N Male to UHF Female	2	\$29.99
DXE-1136-2	BNC Male to UHF Female, Straight	2	\$23.99
DXE-170321114-2	N Female to UHF Male	2	\$16.99
DXE-1037-1-2	N Male to BNC Female	2	\$29.99
DXE-1023-2	N Double Female Bulkhead	2	\$34.99
DXE-1134-2	BNC Double Female Barrel	2	\$17.99
DXE-1140-2	BNC Female to RCA Male	2	\$19.99
DXE-11141704-2	N Female to UHF Female	2	\$13.99
DXE-1144-2	BNC Female to F Male	2	\$18.99
DXE-170321114-2	N Female to UHF Male	2	\$16.99
DXE-170321315-2	BNC Female to UHF Male	2	\$13.99
DXE-1155-2	BNC Male to F Female	2	\$9.59
DXE-1477-6	F Double Female Bulkhead	6	\$5.49
DXE-1038-1-2	N Female to BNC Male	2	\$32.99

We stock many more items than we can show. See them all at DXEngineering.com!



Coaxial Connectors

Though they're designed to work flawlessly with Times Microwave's own designs, these connectors also work well on various other types of coaxial cable. They are offered in three different body designs: a familiar knurled type, a hex head for an open-end wrench and a hybrid knurled/nut mix.

Solderless Center Pin Connectors

DX Engineering now carries Times Microwave Solderless Center Pin Connectors in various body styles and connector types for fitment on specific LMR coaxial cables. You'll find a few in the table below. Enter "TMV-EZ" at DXEngineering.com to view the entire lineup or enter "Coaxial Connector" to view the many options available.

Part Number	Connector	Gender	Body	Fits Cable	Price
Crimp-On Center Pin Connector, Crimp Shield					
TMV-EZ-240-NF-X	Type N	Female	Knurled/Nut	LMR-240	\$13.35
TMV-EZ-240-NMH-X	Type N	Male	Knurled/Nut	LMR-240	\$14.39
TMV-EZ-240-SM-X	SMA	Male	Nut	LMR-240	\$10.69
TMV-EZ-400-716MX	7-16 DIN	Male	Nut	LMR-400	\$25.99
TMV-EZ-400-NF-X	Type N	Female	Knurled	LMR-400	\$19.89
TMV-EZ-400-NMH-X	Type N	Male	Knurled/Nut	LMR-400	\$15.59
TMV-EZ-400-TM-X	TNC	Male	Knurled/Nut	LMR-400	\$14.39
TMV-EZ-400-TMRAX	TNC	Male	Right Angle	LMR-400	\$24.79
TMV-EZ-600-716FX	7-16 DIN	Female	Knurled	LMR-600	\$38.99
TMV-EZ-600-NMC2D	Type N	Male	Knurled/Nut	LMR-600	\$25.99
TMV-EZ-600-NMH-X	Type N	Male	Knurled/Nut	LMR-600	\$22.75
Solder-On Center Pin Connector, Crimp Shield					
TMV-TC-195-NMH-X	Type N	Male	Knurled/Nut	LMR-195	\$8.59
TMV-TC-240-BMRAD	BNC	Male	Right Angle	LMR-240	\$20.99
TMV-TC-240-BM-X	BNC	Male	Knurled	LMR-240	\$12.99
TMV-TC-240-MUHF	PL-259	Male	Mini-UHF	LMR-240	\$5.09
TMV-TC-240-NMH-X	Type N	Male	Knurled/Nut	LMR-240	\$15.89
TMV-TC-400-NF-X	Type N	Female	Knurled	LMR-400	\$20.65
TMV-TC-400-NMH-X	Type N	Male	Knurled/Nut	LMR-400	\$15.59
TMV-TC-400-NMC-2	Type N	Male	Knurled/Nut	LMR-400	\$15.09
Solderless Center Pin Connector					
TMV-EZ-400NMHRAX	Type N	Male	Right Angle	LMR-400	\$31.19
TMV-EZ-600NMHRAX	Type N	Male	Right Angle	LMR-600	\$32.49
TMV-EZ-195-BM-X	BNC	Male	Straight	LMR-195	\$12.59
TMV-EZ-195-TM-X	TNC	Male	Straight	LMR-195	\$13.69
TMV-EZ-195-UM-X	PL-259	Male	Straight	LMR-195/200	\$27.99
TMV-EZ-240-UM-X	PL-259	Male	Straight	LMR-240	\$28.09
TMV-EZ-400-UM-X	PL-259	Male	Straight	LMR-400	\$27.49
TMV-EZ-400-UMRAX	PL-259	Male	Right Angle	LMR-400	\$50.59
TMV-EZ-600-UM-X	PL-259	Male	Straight	LMR-600	\$31.79
TMV-TC-240-SMSSX	SMA	Male	Straight	LMR-240	\$11.29
TMV-TC-400-TM-X	TNC	Male	Straight	LMR-400	\$12.65
TMV-TC-600-NHM-X	Type N	Male	Straight	LMR-600	\$21.45

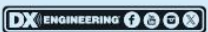

Check out our blog, OnAllBands.com, for articles on upcoming DXpeditions, what's new in contesting, digital operations, and a range of other topics. Want more? We've got loads of tech videos and interviews on the DX Engineering YouTube channel. Of course, when you want personal attention, our experts are only an email or phone call away.

DXEngineering.com is loaded with detailed photos, specs, videos, and more!



Coaxial Cable Crimping Tools

The final step of a connector installation is the proper electro-mechanical crimp contact. These tools are cable-size specific and optional die sets are available separately to expand the tools' versatility.

TMV-CT-240200195	Crimp Tool with Dies for LMR-100/195/200/240 Cable	\$230.99
TMV-CT-400-300	Crimp Tool with Dies for LMR-300/400 Cable	\$203.99
TMV-CT-U	Crimp Tool, Dies Sold Separately	\$503.99
TMV-CT-600	Crimp Tool with Fixed Die for LMR-600 Cable	\$203.99
TMV-Y1719	Crimp Dies for 3/8" LMR-400 Cable	\$305.99
TMV-Y1720	Crimp Dies for TC/EZ-600 Style Connectors	\$305.99



4-Piece LMR-400 Coax Preparation Tool Kit

Times Microwave has made it convenient for you to give your station a coax upgrade. This complete kit includes the tools you need to install Times Microwave crimp-style connectors on LMR-400 cables. You receive cable cutter, strip tool, crimp tool with crimping die, and tool bag.



Coaxial Cable Prep Tools

Times Microwave offers prep tools tailored specifically to its cable. This professional-caliber equipment is a must for any Ham Operator who does a lot of LMR cable assembly. Improper cable prep can have a dramatic affect on station performance, so ensure yours is correct. The CST-240A requires a separate deburring tool, while the 400/600 have built-in deburring capability.



DX Engineering has an enormous array of cable prep tools. Find them all at DXEngineering.com.

TMV-CST-240A	Coaxial Cable Prep Tool for LMR-240 Cable.....	\$138.99
TMV-CST-400	Coaxial Cable Prep Tool for LMR-400 Cable.....	\$140.99
TMV-CST-600	Coaxial Cable Prep Tool for LMR-600 Cable.....	\$152.99
TMV-RB-CST	Replacement Blades for CST Series Prep Tools.....	\$63.99

Cable Hoisting Grips

We've all done it—tied rope directly to the coax to pull it up to an installation. Problem is, that method can crush, deform or break the cable. These grips will safely lift your cable up a tower, to your roof or through a ceiling.



TMV-HG-400T	Cable Hoisting Grip, for LMR-400/0.4" OD Jacket Cable.....	\$23.49
TMV-HG-600T	Cable Hoisting Grip, for LMR-600/0.6" OD Jacket Cable.....	\$34.65

Cable Cutting Tool



Clean, square cuts on your cable are essential for a clean connector installation. The CCT-02 cutter will work with virtually any cable with a 3/8" to 1/2" OD and delivers that critical first step of cable prep. The CCT-03 model is made for LMR-600 and smaller cables.



TMV-CCT-02	Cable Cutting Tool	\$60.99
TMV-CCT-03	Cable Cutting Tool, LMR-600 and Smaller Coax	\$60.99

RG-174 and RG-316 Coaxial Cable Assemblies

These precision-crafted, lightweight, flexible, and low-loss cable assemblies are engineered for special RF device interconnections up to 6 GHz. They feature PTFE dielectric insulating material, outstanding UV and chemical resistance to ensure durability in challenging environments, a wide operational temperature range, and quality BNC or SMA connectors. Available in a variety of lengths and configurations as singles or in pairs.



CEW-316DS006

RG-316 Coaxial Cable

Assemblies feature FEP (Fluorinated Ethylene Propylene) jackets; braided, silver-plated copper shields; and 24 AWG center conductor gauge wire.

CEW-316DB005	BNC Male, 5', Each.....	\$10.99
CEW-316DB010	BNC Male, 10', Each.....	\$15.99
CEW-316DB015	BNC Male, 15', Each.....	\$19.99
CEW-316DB020	BNC Male, 20', Each.....	\$23.99
CEW-316DE001-2	SMA Female, 1', Pair.....	\$14.99
CEW-316DE002-2	SMA Female, 2', Pair.....	\$16.99
CEW-316DE003-2	SMA Female, 3', Pair.....	\$17.99
CEW-316DE006	SMA Female, 6', Each.....	\$11.99
CEW-316DES001-2	SMA Male to SMA Female, 1', Pair.....	\$13.99
CEW-316DES002-2	SMA Male to SMA Female, 2', Pair.....	\$15.99
CEW-316DES003-2	SMA Male to SMA Female, 3', Pair.....	\$18.99
CEW-316DES006	SMA Male to SMA Female, 6', Each.....	\$11.99
CEW-316DS001-2	SMA Male, 1', Pair.....	\$12.99
CEW-316DS002-2	SMA Male, 2', Pair.....	\$14.99
CEW-316DS003-2	SMA Male, 3', Pair.....	\$15.99
CEW-316DS006	SMA Male, 6', Each.....	\$10.99

RG-174 Coaxial Cable

Assemblies feature PVC (Polyvinyl Chlorine) jackets; braided, tinned copper shields; copper-clad steel center conductors; and 26 AWG center conductor gauge wire.

CEW-174DB005-2	BNC Male, 5', Pair.....	\$12.99
CEW-174DB010-2	BNC Male, 10', Pair.....	\$15.99
CEW-174DB015-2	BNC Male, 15', Pair.....	\$17.99
CEW-174DB020	BNC Male, 20', Each.....	\$9.99

RG-6/U 75 Ω Quad-Shield Coaxial Cable Assemblies

We add a pair of high-quality weather sealed compression male F connectors to our RG-6/U cable to create pre-made cable assemblies for your shack. The assemblies are precision manufactured and machine-terminated to ensure that these are the lowest loss and most durable cable assemblies on the market. Need a custom assembly made? Visit DXEngineering.com, use our free online Custom Cable Builder and we'll create it for you.



DXE-RG6UQF003

RG-6/U Coaxial Cable Assembly

DXE-RG6UQF003	3'.....	\$28.99
DXE-RG6UQF006	6'.....	\$30.99
DXE-RG6UQF012	12'.....	\$33.99
DXE-RG6UQF025	25'.....	\$41.99
DXE-RG6UQF050	50'.....	\$49.99
DXE-RG6UQF100	100'.....	\$64.99
DXE-RG6UQF150	150'.....	\$76.99
DXE-RG6UQF200	200'.....	\$86.99

F Connector Tightening Tool

This tool installs and removes F Connectors in high density and hard to reach locations. It helps ensure proper connections to reduce the possibility of loose connector related problems. It is the only tool that works with bent coax. Only finger force is required.



DXE-CIT-1	F Connector Tightening Tool.....	\$19.99
-----------	----------------------------------	----------------

DX ENGINEERING

RG-6/U 75 Ω Quad-Shield Coaxial Cable

DX Engineering RG-6/U 75 Ω Quad-Shield Coaxial Cables are now offered in two versions: DXE-RG6UQF is our top-of-the-line, direct-bury waterproof self-healing quad-shield cable with a Type-III PE (polyethylene) jacket and flooding compound; DXE-RG6UQ is our standard quad-shield cable with Type-II PVC jacket. Our excellent RG-6/U cables are tough and very flexible, made with low-loss gas-injected foam polyethylene dielectric and a 18 AWG copper-clad steel center conductor. Two 100% coverage foil shields plus two aluminum braids provide ultimate four-layer RF shielding and both black jacket types are UV protected. Extremely strong and durable, they're ideal for Amateur Radio and SWL receive antenna arrays, magnetic loops, beverage antennas, over-the-air TV, AM and FM broadcast reception, CATV systems and audio/video distribution systems. Both are terminated with the same Type-F universal compression connectors.

Available by-the-foot or in 1,000' spools, both quad-shield cables have a 75 Ω nominal impedance, with a velocity factor of 82% and nominal loss of only 0.6 dB/100 Ft. at 1 MHz, providing your best ultra-high quality RG-6/U Quad-Shield cable solution.

DXE-RG6UQF	RG-6/U, 75 Ω, Flooded Quad Shield, Direct Bury, Waterproof PE Jacket	per foot \$0.37
DXE-RG6UQF-1000	RG-6/U, 75 Ω, Flooded Quad Shield, Direct Bury, Waterproof PE Jacket.....	1,000' Spool \$255.99
DXE-RG6UQ-CTL	RG-6/U, 75 Ω, Standard Quad Shield, PVC Jacket.....	per foot \$0.39
DXE-RG6UQ-1000	RG-6/U, 75 Ω, Standard Quad Shield, PVC Jacket.....	1,000' Spool \$219.99



DXE-8XDB050

DX ENGINEERING

RG-8X BNC Jumper Cable Assemblies

These male BNC jumper cables feature secure, crimped connectors and tube-shrink seals, which make them impervious to the elements. They are Hi-Pot tested. In addition to 50 Ω assemblies, there are 75 Ω assemblies available as well.

DXE-8XDB002	RG-8X BNC Jumper Cable, 2'.....	\$35.99
DXE-8XDB003	RG-8X BNC Jumper Cable, 3'.....	\$36.49
DXE-8XDB006	RG-8X BNC Jumper Cable, 6'.....	\$37.99
DXE-8XDB012	RG-8X BNC Jumper Cable, 12'.....	\$40.99
DXE-8XDB025	RG-8X BNC Jumper Cable, 25'.....	\$52.99
DXE-8XDB050	RG-8X BNC Jumper Cable, 50'.....	\$65.99

COMET

Window Feed-Thru Jumper

This 16 inch long feed-through lets you slip a flexible cable underneath your window sash. It handles 100 W (PEP), has an SWR under 1.3:1 (below 500 MHz) and uses two SO-239 connectors.

With a nominal loss of .5 dB up to 500 MHz, it's a solution that will please everyone.

CMA-CTC-50M	Feed-Thru Jumper.....	\$59.99
-------------	-----------------------	----------------



DX ENGINEERING

F-Connector Coax Cable Tool Kit

Housed in a sturdy case with precut foam, DX Engineering's UT-KITF tool kit includes stripping tool for RG-6U dual shield/quad shield and F-6 size cable, 25 Universal Compression F-connectors for any RG-6U or F-6 cables, F-connector compression tool, coaxial cable shears, F-connector tightening tool, and stripping tool replacement blades. The universal connectors fit any RG6 cable, eliminating the hassle of using color-coded F-connector types.

DXE-UT-KITF	F-Connector Coax Cable Tool Kit.....	\$195.99
-------------	--------------------------------------	-----------------



DXE-EX6XL-10

DXE-SNS-CT1

DXE-CPT-659

DX ENGINEERING

EX6XL Type-F Universal Compression Connectors

These heavy-duty, metal-body and black plastic connectors (direct replacements for all previous blue and purple F connectors) work on all RG6U coaxial cables, solving the problem of identifying cable type and figuring out which compression connector to use. The EX6XL's unique design fits any RG6 and RG6U coaxial cables, standard or self-healing (flooded). The moisture-tight connectors install onto RG6U 60% braid, dual shield, such as RG-6U and F-6, including legacy DXE-F6 and DXE-6UF, as well as all Quad Shield RG-6U, including DXE-RG6UQF and DXE-RG6UQ. They are easily installed with common F-connector compression tools such as the RG6 Type-F Compression Connector Tool (DXE-SNS-CT1).

DXE-EX6XL-10	Type-F Universal Compression Connector, 10 Pack.....	\$13.99
DXE-EX6XL-25	Type-F Universal Compression Connector, 25 Pack.....	\$27.99
DXE-SNS-CT1	RG6 Type-F Compression Connector Tool.....	\$53.99
DXE-CPT-659	Coax Cable Stripper for RG-6 and RG-59.....	\$36.99

DIAMOND ANTENNA

Through Window/Door Cable Set

Pass this set through the narrow openings of a window, door or even a vent. This 20 inch cable has an SO-239 connector at each end to make installation easy. It can handle up to 150 watts with a VSWR less than 1.2:1 at up to 500 MHz and an insertion loss lower than 1.7 dB.

DMN-MGC50	Through Window/Door Cable Set.....	\$56.99
-----------	------------------------------------	----------------



DX Engineering carries equipment from more than 160 top manufacturers!

High Performance Coaxial Cable and Cable Assemblies



DX Engineering Coaxial Cables are made to our strict specifications to ensure that your bulk cable or cable assembly purchase will perform beyond expectations, offering the greatest and longest lasting value for your radio installation. DX Engineering 400MAX, 8U, 8X and 11U coaxial cables feature ultra-low loss gas-injected foam cable dielectrics while 213U and 58AU cables feature rugged and flexible solid dielectrics to handle the elevated SWR of some high-performance HF antenna installations. All DX Engineering cables have excellent weather resistant jackets and our 50-ohm coaxial cables feature stranded copper center conductors for the best connections and long-term flexibility.

Now installed on all of DX Engineering Coaxial Cable Assemblies with PL-259s, our revolutionary Next Generation connectors combine the best qualities of solder

and crimp technologies for unparalleled reliability and the lowest loss. These 50-ohm coaxial cable assemblies feature hand-soldered center pins, machine crimped shields and are finished with weather-sealed shrink tube so they are highly resistant to moisture and wear.

We offer an extensive line of coaxial cables sold in bulk, by the foot and by the roll. Cable preparation tools and different types of coaxial connectors are available here. See our new Custom Cable Builder system for ordering custom cable assemblies with thousands of cable types, lengths and connector combinations that will satisfy nearly every RF application. Visit DXEngineering.com to see our comprehensive bulk cable and coaxial cable assembly offerings.



DXE-400MAX Low-Loss			DXE-213U MIL-Spec			DXE-8U Low-Loss Foam Dielectric			DXE-8X Low-Loss Foam Dielectric		
DXE-400MAXDX003	3 Feet	\$40.99	DXE-213UDX003	3 Feet	\$39.99	DXE-8UDX002	2 Feet	\$38.99	DXE-8XDX1-5	1.5 Feet	\$36.99
DXE-400MAXDX006	6 Feet	\$44.99	DXE-213UDX006	6 Feet	\$43.99	DXE-8UDX003	3 Feet	\$39.99	DXE-8XDX002	2 Feet	\$38.49
DXE-400MAXDX012	12 Feet	\$52.99	DXE-213UDX012	12 Feet	\$55.99	DXE-8UDX006	6 Feet	\$43.99	DXE-8XDX003	3 Feet	\$38.99
DXE-400MAXDX018	18 Feet	\$60.99	DXE-213UDX018	18 Feet	\$63.99	DXE-8UDX012	12 Feet	\$51.99	DXE-8XDX006	6 Feet	\$40.99
DXE-400MAXDX025	25 Feet	\$70.99	DXE-213UDX025	25 Feet	\$72.99	DXE-8UDX018	18 Feet	\$58.99	DXE-8XDX012	12 Feet	\$43.99
DXE-400MAXDX050	50 Feet	\$109.99	DXE-213UDX050	50 Feet	\$105.99	DXE-8UDX025	25 Feet	\$66.99	DXE-8XDX015	15 Feet	\$45.99
DXE-400MAXDX075	75 Feet	\$144.99	DXE-213UDX075	75 Feet	\$149.99	DXE-8UDX050	50 Feet	\$99.99	DXE-8XDX018	18 Feet	\$49.99
DXE-400MAXDX100	100 Feet	\$179.99	DXE-213UDX100	100 Feet	\$184.99	DXE-8UDX075	75 Feet	\$132.99	DXE-8XDX025	25 Feet	\$52.99
DXE-400MAXDX125	125 Feet	\$225.99	DXE-213UDX125	125 Feet	\$222.99	DXE-8UDX100	100 Feet	\$165.99	DXE-8XDX050	50 Feet	\$65.99
DXE-400MAXDX150	150 Feet	\$257.99	DXE-213UDX150	150 Feet	\$259.99	DXE-8UDX125	125 Feet	\$196.99	DXE-8XDX075	75 Feet	\$78.99
DXE-400MAXDX175	175 Feet	\$296.99	DXE-213UDX175	175 Feet	\$299.99	DXE-8UDX150	150 Feet	\$229.99	DXE-8XDX100	100 Feet	\$91.99
DXE-400MAXDX200	200 Feet	\$334.99	DXE-213UDX200	200 Feet	\$339.99	DXE-8UDX175	175 Feet	\$256.99	DXE-8XDX150	150 Feet	\$125.99
DXE-400MAX	Per Foot	\$1.49	DXE-213U	Per Foot	\$1.60	DXE-8UDX200	200 Feet	\$289.99	DXE-8X	Per Foot	\$0.65
DXE-400MAX-500	500' Spool	\$744.99	DXE-213U-500	500' Spool	\$699.99	DXE-8U	Per Foot	\$1.29	DXE-8X-1000	1,000' Spool	\$599.99
DXE-400MAX-1000	1,000' Spool	\$1,489.99	DXE-213U-1000	1,000' Spool	\$1,299.99	DXE-8U-500	500' Spool	\$549.99			
						DXE-8U-1000	1,000' Spool	\$1,059.99			



RG-214 Double Shielded 50 Ω Coaxial Cable and Assemblies



When your project demands exceptional, long-lasting coax performance in the shack and on the tower, depend on DX Engineering RG-214 Double Shielded 50 Ω Coaxial Cable Assemblies. Available in lengths from 3 to 25 feet, these assemblies feature specially manufactured coax with 12-gauge silver-plated stranded copper center conductor, solid polyethylene dielectric, and TWO layers of silver-plated braided copper shields. This tough yet flexible coax has proven to provide exceptional RF isolation performance and superior power handling. They are the best choice for applications in which many cables are bundled together and higher RF isolation is desired, and when an antenna feedline is looped (e.g., a rotator loop). The solid dielectric allows for repeated flexing without damaging the center conductor. Choose assemblies terminated with either Amphenol 83-1SP silver-plated PL-259 connectors or DX Engineering silver-plated Type N connectors.

RG-214 Assemblies with Type N Male Connectors on Both Ends

DXE-214N003	3'	\$79.99
DXE-214N006	6'	\$99.99
DXE-214N012	12'	\$139.99
DXE-214N018	18'	\$182.99
DXE-214N025	25'	\$225.99

RG-214 Assemblies with 83-1SP PL-259 Connectors on Both Ends

DXE-214R003	3'	\$73.99
DXE-214R006	6'	\$91.99
DXE-214R012	12'	\$135.99
DXE-214R018	18'	\$177.99
DXE-214R025	25'	\$217.99

RG-214 Double Shielded 50 Ω Bulk Coaxial Cable

DXE-214	per foot	\$9.49
DXE-214-1000	1,000' Spool	\$8,899.99



RG-400 High Isolation Double Shielded 50 Ω Coaxial Cable

DX Engineering RG-400 High Isolation Coaxial Cable brings to your RF systems the same quality and capabilities that are demanded of military and aerospace installations. Available as assemblies or by the foot, RG-400 provides extremely high noise and signal isolation and will handle up to 8 kW. It boasts an efficient, stranded silver-covered copper center conductor and double silver-covered copper braided shields. The cable is wrapped in a tough, waterproof fluorinated ethylene propylene jacket. RG-400 cable assemblies are terminated with classic silver-plated Amphenol 83-1SP PL-259 and UG-175 reducers or BNC male connectors. RG-400 may be the same size as RG-58A/U, but it is an aerospace-level performance cable with dramatically improved ratings in all categories. This cable is Mil-Spec equivalent to M17/128-RG400.

RG-400 High Isolation Coaxial Cable Assemblies, 83-1SP Ends

DXE-RG400R003	RG400 High Isolation Coaxial Cable, 3'	\$89.99
DXE-RG400R006	RG400 High Isolation Coaxial Cable, 6'	\$105.99
DXE-RG400R010	RG400 High Isolation Coaxial Cable, 10'	\$127.99

RG-400 High Isolation Coaxial Cable Assemblies, BNC Male Ends

DXE-RG400B003	RG400 High Isolation Coaxial Cable, 3'	\$86.99
DXE-RG400B006	RG400 High Isolation Coaxial Cable, 6'	\$103.99
DXE-RG400B010	RG400 High Isolation Coaxial Cable, 10'	\$125.99

RG-400 Bulk Coaxial Cable
 DXE-RG400-CTL..... per foot **\$5.59**
NOTE: RG-400 has an OD of 0.195" and is NOT the same as DXE-400MAX, which is 0.405" OD.



Check out our YouTube channel for in-depth tech tips and product demos!

DXE-400MAX
Low-Loss Cable 50 Ohm



Gas-Injected Foam Won't Absorb Water

- Low-loss, gas-injected foam polyethylene dielectric bonded tape foil covered by a braided copper shield
- .405" low-density polyethylene jacket
- Waterproof
- UV-resistant, ideal for outdoor use
- Direct bury

Attenuation/ 100 Ft.	Power Rating	Efficiency %
0.3 dB @ 5 MHz	6.9 kW	93%
0.5 dB @ 10 MHz	4.8 kW	90%
0.8 dB @ 30 MHz	2.8 kW	83%
1.1 dB @ 50 MHz	2.1 kW	79%
1.8 dB @ 150 MHz	1.2 kW	65%
3.3 dB @ 450 MHz	0.7 kW	47%

Velocity Factor: 84% (0.84)

Minimum Bend Radius:	6" Repeated Bends
	2.5" Fixed Install

DXE-400MAX per foot **\$1.49**
 DXE-400MAX-50 500' Spool **\$744.99**
 DXE-400MAX-100 1,000' Spool **\$1,489.99**

DXE-8U Low-Loss 50 Ohm
Foam Dielectric Cable



Gas-Injected Foam Won't Absorb Water

- Low-loss, gas-injected foam polyethylene dielectric
- .405" high-flex PVC jacket
- Low-loss foam dielectric
- Braided copper shield

Attenuation/ 100 Ft.	Power Rating	Efficiency %
0.3 dB @ 5 MHz	5.4 kW	93%
0.6 dB @ 10 MHz	3.4 kW	87%
1.0 dB @ 30 MHz	2.0 kW	79%
1.3 dB @ 50 MHz	1.5 kW	73%
2.2 dB @ 150 MHz	1.0 kW	60%

Velocity Factor: 81% (0.81)

Minimum Bend Radius:	6" Repeated Bends
	2.5" Fixed Install

DXE-8U per foot **\$1.29**
 DXE-8U-500 500' Spool **\$549.99**
 DXE-8U-1000 1,000' Spool **\$1,059.99**

DXE-8X Low-Loss 50 Ohm
Foam Dielectric Cable
(also known as RG-8X or Mini-8)



Gas-Injected Foam Won't Absorb Water

- Low-loss, gas-injected foam polyethylene dielectric
- Very flexible; ideal for short, in-shack jumper cables
- .242" Type II jacket is non-contaminating and UV-resistant
- Direct bury

Attenuation/ 100 Ft.	Power Rating	Efficiency %
0.6 dB @ 5 MHz	3.0 kW	86%
0.9 dB @ 10 MHz	2.2 kW	81%
1.4 dB @ 30 MHz	1.2 kW	69%
2.0 dB @ 50 MHz	0.9 kW	62%
3.8 dB @ 150 MHz	0.4 kW	42%

Velocity Factor: 78% (0.78)

Minimum Bend Radius: 2.4"

DXE-8X per foot **\$0.65**
 DXE-8X-1000 1,000' Spool **\$599.99**

DXE-213U MIL-Spec
50 Ohm Cable



- Solid polyethylene dielectric
- Okay for repeated bending
- Recommended for rotator loops
- .405" Type II jacket is non-contaminating and UV-resistant, suitable for outdoor use
- Direct bury
- Braided copper shield

Attenuation/ 100 Ft.	Power Rating	Efficiency %
0.4 dB @ 5 MHz	4.9 kW	90%
0.6 dB @ 10 MHz	3.4 kW	87%
1.0 dB @ 30 MHz	2.0 kW	79%
1.3 dB @ 50 MHz	1.5 kW	73%
2.4 dB @ 150 MHz	0.9 kW	57%

Velocity Factor: 66% (0.66)

Minimum Bend Radius: 5"
Recommended for Rotator Loops

DXE-213U per foot **\$1.60**
 DXE-213U-500 500' Spool **\$699.99**
 DXE-213U-1000 1,000' Spool **\$1,299.99**

DXE-58AU
52 Ohm Cable



- 19 strands - 20 AWG center conductor
- Polyethylene dielectric
- Tinned braided copper shield
- 95-97% shield coverage
- .195" PVC Type I jacket

Attenuation/ 100 Ft.	Power Rating
0.5 dB @ 1 MHz	1,000 W
1.5 dB @ 5 MHz	600 W
2.8 dB @ 30 MHz	350 W
3.0 dB @ 50 MHz	250 W
4.0 dB @ 150 MHz	150 W

Velocity Factor: 66% (0.66)

Minimum Bend Radius: 3"

DXE-58AU per foot **\$0.55**

DXE-RG400-CTL 50 Ohm
High Isolation - High Power



- Solid polytetrafluoroethylene (PTFE) dielectric
- Silver-plated copper braid - 2 layers
- 95-97% shield coverage
- 20 AWG silver-clad copper center conductor
- .195" FEP jacket UV-resistant
- High isolation - High power

Attenuation/ 100 Ft.	Power Rating
0.4 dB @ 1 MHz	5.0 kW
0.9 dB @ 5 MHz	5.0 kW
2.2 dB @ 30 MHz	2.75 kW
2.9 dB @ 50 MHz	2.1 kW
5.1 dB @ 150 MHz	1.2 kW
9.1 dB @ 450 MHz	670 W

Velocity Factor: 69.5% (0.695)

Minimum Bend Radius: 1"

DXE-RG400-CTL per foot **\$5.59**

DXE-11U
75 Ohm Low-Loss Cable



Gas-Injected Foam Won't Absorb Water

- Low-loss, gas-injected PE foam dielectric
- .405" low-density polyethylene jacket
- Black UV-resistant, ideal for outdoor use
- Waterproof PE jacket
- Direct bury

Attenuation/ 100 Ft.	Power Rating
0.2 dB @ 1 MHz	5.0 kW
0.3 dB @ 5 MHz	3.6 kW
0.4 dB @ 10 MHz	2.5 kW
0.7 dB @ 30 MHz	1.5 kW
1.0 dB @ 50 MHz	1.0 kW
1.8 dB @ 150 MHz	250 W
3.3 dB @ 450 MHz	100 W

Velocity Factor: 82% (0.82)

Minimum Bend Radius: 4"

DXE-11U per foot **\$1.49**

DXE-214
50 Ohm Cable



Silver Plated Braids and Center Conductor

- Superior Shielding Dual Silver Plated Copper Braids - 96% and 97% coverage
- .425 Type II-A jacket is non-contaminating and UV-resistant, suitable for outdoor use and direct-bury
- Solid Polyethylene Dielectric
- Ideal for Rotator Loops
- For use with solder type connectors

Attenuation/ 100 Ft.	Power Rating
0.4 dB @ 5 MHz	4.9 kW
0.6 dB @ 10 MHz	3.4 kW
1.0 dB @ 30 MHz	2.0 kW
1.3 dB @ 50 MHz	1.5 kW
1.9 dB @ 100 MHz	0.9 kW

Velocity Factor: 66% (0.66)

Minimum Bend Radius: 5"

DXE-214 per foot **\$9.49**
 DXE-214-1000 1,000' Spool **\$8,899.99**

Need a custom cable assembly? Check out the Online Custom Cable Builder.



DX Engineering Ladder Line

DXE-LL450-CTL	450 Ω Ladder Line	per foot	\$1.20
DXE-LL300-1C	300 Ω Ladder Line, 100'		\$56.99
DXE-LL300-2C	300 Ω Ladder Line, 200'		\$137.99
DXE-LL300-3C	300 Ω Ladder Line, 300'		\$169.99
DXE-LL300-5C	300 Ω Ladder Line, 500'		\$281.99
DXE-LL450-5C	450 Ω Ladder Line, 500'		\$385.99
DXE-LL450-1K	450 Ω Ladder Line, 1,000'		\$792.99



Power Wire, 2 Conductor Zip Cord

Zip Cord is two-conductor cord which is typically used for low voltage DC power wiring circuits. The red and black colors make it simple to identify polarity for DC applications.

DXE-PW-8	Power Wire, 8-Gauge	per foot	\$1.49
DXE-PW-10	Power Wire, 10-Gauge	per foot	\$2.12
DXE-PW-12	Power Wire, 12-Gauge	per foot	\$1.82
DXE-PW-14	Power Wire, 14-Gauge	per foot	\$0.89
DXE-PW-16	Power Wire, 16-Gauge	per foot	\$0.55
DXE-PW-18	Power Wire, 18-Gauge	per foot	\$0.47



DX Engineering Premium Radial Wire

14 AWG stranded copper, UV-resistant relaxed black PVC insulation.

DXE-RADW-500	500' Spool	\$110.99
DXE-RADW-1000	1,000' Spool	\$207.99



Ground Strap

DX Engineering offers quality tinned copper braid in 5 widths for grounding applications. It is sold per foot to accommodate almost any project. Very long per-foot lengths may not be continuous—contact Customer Service to discuss your length needs if continuous length is required. The strap is available in these sizes:

DXE-TCB-038	3/8" wide x 1/32" thick	per foot	\$0.85
DXE-TCB-050	1/2" wide x .030" thick	per foot	\$1.02
DXE-TCB-063	5/8" wide x .030" thick	per foot	\$1.52
DXE-TCB-075	3/4" wide x .040" thick	per foot	\$1.87
DXE-TCB-100	1" wide x .045" thick	per foot	\$2.25



DX Engineering RG-6/U 75 Ω Quad-Shield Bulk Coaxial Cable

DXE-RG6UQ-CTL	RG-6/U 75 Ω Quad-Shield Cable	per foot	\$0.39
DXE-RG6UQ-1000	RG-6/U 75 Ω Quad-Shield Cable	1,000' Spool	\$219.99



Times Microwave Systems LMR-195 Bulk Coaxial Cable

TMV-LMR-195	per foot	\$0.84
-------------	----------	---------------



Times Microwave Systems LMR-240 Bulk Coaxial Cable

TMV-LMR-240	per foot	\$1.14
-------------	----------	---------------



Times Microwave Systems LMR-240 Ultra Flex Bulk Coaxial Cable

TMV-LMR-240ULTRA	per foot	\$1.39
------------------	----------	---------------



Times Microwave Systems LMR-400 Bulk Coaxial Cable

TMV-LMR-400	per foot	\$1.62
TMV-LMR-400-500	500' Spool	\$809.99



Times Microwave Systems LMR-400 Ultra Flex Bulk Coaxial Cable

TMV-LMR-400ULTRA	per foot	\$2.33
------------------	----------	---------------



Times Microwave Systems LMR-600 Bulk Coaxial Cable

TMV-LMR-600	per foot	\$2.92
-------------	----------	---------------



Times Microwave Systems LMR-600 Ultra Flex Bulk Coaxial Cable

TMV-LMR-600ULTRA	per foot	\$4.37
------------------	----------	---------------



Heil Sound Microphone Cable

HLS-HW-10	10 Feet	\$15.00
HLS-HW-20	20 Feet	\$25.00
HLS-HW-50	50 Feet	\$65.00

See page 30 for full specifications.



DX Engineering 75 Ω Flooded Quad Shield Bulk Coaxial Cable

DXE-RG6UFQ	per foot	\$0.37
DXE-RG6UFQ-1000	1,000' Spool	\$255.99



DX Engineering Heavy Duty Rotator Control Cable

DXE-CW18120R	per foot	\$2.05
--------------	----------	---------------

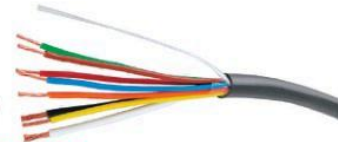

DX Engineering 8 Conductor Heavy Duty Control Cable

DXE-CW8-HD	per foot	\$2.59
DXE-CW8-HD-1000	1,000' Spool	\$1,449.95



DX Engineering 8 Conductor Control Cable

DXE-CW8	per foot	\$1.40
DXE-CW8-1000	1,000' Spool	\$776.99



DX Engineering 8 Conductor Plus Shield CAT5e Control Cable

DXE-CW9	per foot	\$0.78
DXE-CW9-1K	1,000' Spool	\$317.99



DX Engineering 9 Conductor Plus Shielded Control Cable

DXE-CW9S	per foot	\$1.59
----------	----------	---------------



COMTEK 3 Conductor Control Cable

COM-CW3	per foot	\$0.49
COM-CW3-1000	1,000' Spool	\$279.99



COMTEK 4 Conductor Control Cable

COM-CW4	per foot	\$0.85
COM-CW4-1000	1,000' Spool	\$237.99



6 Conductor + Consolidated Drain Wire Control Cable

CEW-5726-CL	per foot	\$0.79
CEW-5726-CL-1K	1,000' Spool	\$749.99



For new hams, check out our Getting Started HT, Mobile, and Base Radio Packages!

Build your dream station with the best gear.

OPEN AN ACCOUNT*, GET THE GEAR, GET ON AIR.



DX Engineering Super Card!
No Interest if Paid in Full within 6, 12, or 18 Months! **

On qualifying purchases made with your DX Engineering Super Card. Interest will be charged to your account from the purchase date if the promotional balance is not paid in full within 6, 12, or 18 months. Minimum monthly payments required.

- 6 months offer applies to purchases of \$199 to \$999.99
- 12 months offer applies to purchases of \$1,000 to \$2,499.99
- 18 months offer applies to purchases of \$2,500 or more

* Subject to credit approval. **Qualifying purchase amount must be on one receipt. No interest will be charged on the promo balance if you pay it off, in full, within the promo period. If you do not, interest will be charged on the promo balance from the purchase date. The required minimum monthly payments may or may not pay off the promo balance before the end of the promo period, depending on purchase amount, promo length and payment allocation. Regular account terms apply to non-promo purchases and, after promo period ends, to the promo balance. For New Accounts: Purchase APR is 29.99% as of January 1, 2024. Minimum Interest Charge is \$2. Existing cardholders: See your credit card agreement terms. Subject to credit approval. Gas station purchases are not eligible for Promotional Financing. Any discount, coupon, manufacturer rebate, or other promotional offer applied at time of purchase, will reduce your total purchase amount and may result in you not satisfying the minimum qualifying purchase amount required.

Visit DXEngineering.com/Supercard

**The DX Engineering Exclusive
CUSTOM CABLE BUILDER**

You decide which cable you want, how long you want it and which connectors you want installed. Our highly trained technical staff will build your cable assembly, and it will endure rigorous hi-pot testing before it leaves our facility.

Mix-and-matching connectors is OK too. For instance, you can put a PL-259 on one cable end and a BNC male on the other. You can also use the Custom Cable Builder to create copper braid assemblies for your specialized grounding applications.

How It Works:

- 1) Select the cable you want to use.
- 2) Enter the desired length of your new assembly.
- 3) Choose the connectors you want on each end.
- 4) Click "Add to Cart" and complete your order.



We'll build your Custom Cable and ship it to you quickly. Watch the video. it's easy, straightforward and intuitive.



Go to YouTube and enter "DXE Cable Builder" or scan the QR Code to watch a video on ordering customized coaxial cables.

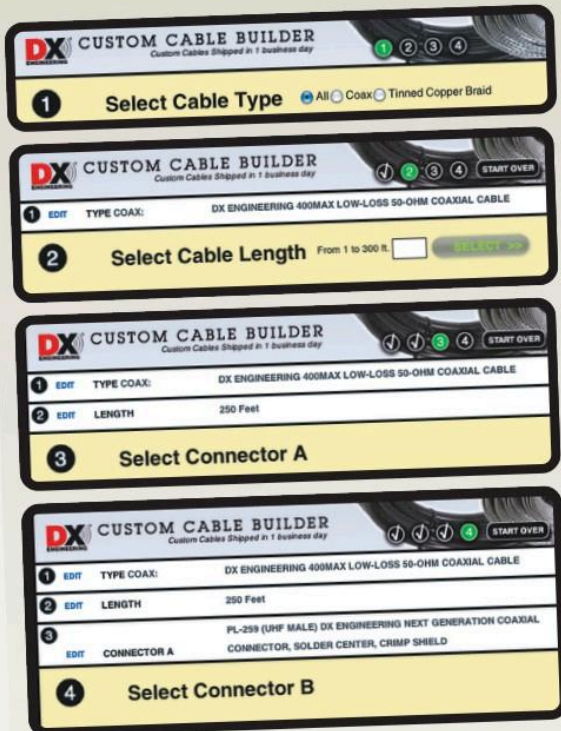



Ham News You Can Use

Check into DX Engineering's blog, OnAllBands.com, for daily articles that enlighten, entertain, challenge and inform. You'll find new product and vendor announcements, tech tips on everything from purchasing the right antenna to operating satellites, QSL card posts highlighting upcoming DXpeditions, ways to use ham radio to make a difference in your community, amateur radio history, and words of wisdom for new licensees from operators who have devoted years to working both sides of the pileup.



1200 Southeast Avenue
Tallmadge, OH 44278 USA



Ordering (via phone) Country Code: +1

9 am to midnight ET, Monday-Friday
9 am to 5 pm ET, Weekends

Phone or e-mail Tech Support: 330-572-3200

9 am to 7 pm ET, Monday-Friday
9 am to 5 pm ET, Saturday

Email: DXEngineering@DXEngineering.com

Ohio Showroom Hours:

9 am to 5 pm ET, Monday-Saturday

Ohio Curbside Pickup:

9 am to 8 pm ET, Monday-Saturday
9 am to 7 pm ET, Sunday

Nevada Curbside Pickup:

9 am to 7 pm PT, Monday-Sunday



Printed in the USA.

800-777-0703 | Email Support 24/7/365 at DXEngineering@DXEngineering.com

ALL Band Radio with Bluetooth

Direct Access to Information Providing All Essentials



JOURNEY
(GOOD)

ODYSSEY
(BETTER)

QUEST
(BEST)

