



BASIC MANUAL

HF/50 MHz TRANSCEIVER

IC-7300MK2



This device complies with part 15 of the FCC Rules. Operation is subject to the condition that this device does not cause harmful interference.

Icom Inc.

Thank you for choosing this Icom product. This product was designed and built with Icom's state of the art technology and craftsmanship. With proper care, this product should provide you with years of trouble-free operation.

IMPORTANT

READ ALL INSTRUCTIONS carefully and completely before using the transceiver.

SAVE THIS INSTRUCTION MANUAL— This instruction manual contains basic operating instructions for the IC-7300MK2. For advanced operating instructions, see the Advanced manual for details.

The Advanced manual can be downloaded from the following internet address:

<https://www.icomjapan.com/support/>

FEATURES

- **RF Direct Sampling System**

The IC-7300MK2 employs an RF direct sampling system. RF signals are directly converted to digital data and processed in the FPGA. This system is a leading technology marking an epoch in amateur radio.

- **Real-Time Spectrum Scope**

The spectrum scope is class-leading in resolution, sweep speed and dynamic range. When you touch the scope screen on the intended signal, the touched area is magnified. The large 4.3 inch color TFT touch LCD offers intuitive operation.

- **CW Decode Function**

The DSP decodes received and transmitted CW characters. The decoded characters are displayed on the decode screen in the CW mode.

- **"IP+" Function**

The IP Plus function improves 3rd order intercept point (IP3) performance. When a weak signal is received adjacent to strong interference, the AD converter is optimized against signal distortion.

- **An HDMI port for connecting an external display**

- **IP remote control capability with the optional**

RS-BA1 Version 2 IP REMOTE CONTROL SOFTWARE

- **A 4.3 inch touch screen color display**

- **A built-in automatic antenna tuner**

- **Multi-function control for easy settings**

SUPPLIED ACCESSORIES

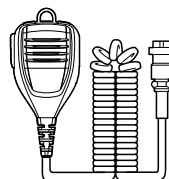

Hand microphone
(HM-219)



ACC plug
(13 pin)



CW key plug
(6.35 mm: 1/4 inch Stereo)



Speaker plug
(3.5 mm: 1/8 inch Stereo)



Spare fuse
(58 V 5 A)

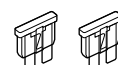

Spare fuse
(32 V 25 A)

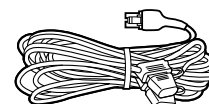

DC power cable
(3 m: 9.8 ft)

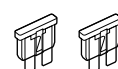

Spare fuse
(32 V 30 A)

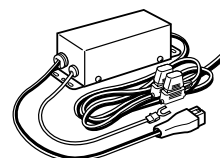

DC power cable
For European versions

① Different types of accessories may be supplied, or may not be supplied depending on the transceiver version.

About weld lines

This product's surfaces may have streaks called "weld lines," that occur during the molding process, and are not cracks or flaws.

EXPLICIT DEFINITIONS

WORD	DEFINITION
⚠ DANGER!	Personal death, serious injury or an explosion may occur.
⚠ WARNING!	Personal injury, fire hazard or electric shock may occur.
CAUTION	Equipment damage may occur.
NOTE	Recommended for optimum use. No risk of personal injury, fire or electric shock.

Icom is not responsible for the destruction, damage to, or performance of any Icom or non-Icom equipment, if the malfunction is because of:

- Force majeure, including, but not limited to, fires, earthquakes, storms, floods, lightning, other natural disasters, disturbances, riots, war, or radioactive contamination.
- The use of Icom transceivers with any equipment that is not manufactured or approved by Icom.

FCC INFORMATION

This equipment has been tested and found to comply with the limits for a Class B digital device, pursuant to part 15 of the FCC Rules.

These limits are designed to provide reasonable protection against harmful interference in a residential installation. This equipment generates, uses, and can radiate radio frequency energy and, if not installed and used in accordance with the instructions, may cause harmful interference to radio communications. However, there is no guarantee that interference will not occur in a particular installation. If this equipment does cause harmful interference to radio or television reception, which can be determined by turning the equipment off and on, the user is encouraged to try to correct the interference by one or more of the following measures:

- Reorient or relocate the receiving antenna.
- Increase the separation between the equipment and receiver.
- Connect the equipment into an outlet on a circuit different from that to which the receiver is connected.
- Consult the dealer or an experienced radio/TV technician for help.

WARNING: MODIFICATION OF THIS DEVICE TO RECEIVE CELLULAR RADIOTELEPHONE SERVICE SIGNALS IS PROHIBITED UNDER FCC RULES AND FEDERAL LAW.

CAUTION: Changes or modifications to this device, not expressly approved by Icom Inc., could void your authority to operate this device under FCC regulations.

Supplier's Declaration of Conformity

This device complies with part 15 of the FCC Rules. Operation is subject to the condition that this device does not cause harmful interference.

• Responsible Party

Company Name: Icom America Inc.
Address: 12421 Willows Road NE,
Kirkland, WA 98034

• U.S. Contact Information

800-USA-ICOM (800-872-4266)
Monday – Friday 7 AM to 5 PM PST

For Canada:

This device contains licence-exempt transmitter(s) that comply with Innovation, Science and Economic Development Canada (ISED)'s licence-exempt RSS(s). Operation is subject to the following two conditions: (1) this device may not cause interference, and (2) this device must accept any interference, including interference that may cause undesired operation of the device.

DISPOSAL



The crossed-out wheeled-bin symbol on your product, literature, or packaging reminds you that in the European Union, all electrical and electronic products, batteries, and accumulators (rechargeable batteries) must be taken to designated collection locations at the end of their working life. Do not dispose of these products as unsorted municipal waste. Dispose of them according to the laws in your area.

ABOUT CE AND DOC



Hereby, Icom Inc. declares that the versions of IC-7300MK2 which have the "CE" symbol on the product, comply with the essential requirements of the Radio Equipment Directive, 2014/53/EU, and the restriction of the use of certain hazardous substances in electrical and electronic equipment Directive, 2011/65/EU. The full text of the EU declaration of conformity is available at the following internet address:
<https://www.icomjapan.com/support/>

These versions also comply with the essential requirements of the Battery Regulation, (EU) 2023/1542.

ABOUT UKCA DOC

To obtain the UKCA Declaration of Conformity, please contact Icom UK Limited by email at info@icomuk.co.uk or alternatively call + 44(0) 1227 741741.

ABOUT SPURIOUS SIGNALS

Spurious signals may be received near the following frequencies. These are made in the internal circuit and does not indicate a transceiver malfunction:

- 2.066 MHz
- 4.133 MHz
- 9.140 MHz
- 27.426 MHz

ABOUT THE TOUCH SCREEN

◇ Touch operation

In the Advanced manual and the Basic manual, the touch operation is described as shown below, with the beep tone ON.



Touch

If the display is touched briefly, one short beep sounds.



Touch for 1 second

If the display is touched for 1 second, one short and one long beep sound.

◇ Touch screen precautions

- The touch screen may not properly work when the LCD protection film or sheet is attached.
- Touching the screen with your finger nails, sharp-tipped object and so on, or touching the screen hard may damage it.
- Tablet PC operations such as flick, pinch in, and pinch out cannot be performed on this touch screen.

◇ Touch screen maintenance

- If the touch screen becomes dusty or dirty, wipe it clean with a soft, dry cloth.
- When you wipe the touch screen, be careful not to push it too hard or scratch it with your finger nails. Otherwise, you may damage the screen.

ABOUT THE MANUALS

You can use the following manuals to understand and operate this transceiver. (As of November 2025)

TIP: You can download each manual and guide from the Icom website.

<https://www.icomjapan.com/support/>
Enter "IC-7300MK2" into the Search box in the site.

- **Basic manual (This manual)**
Instructions for basic operations.
- **Advanced manual (PDF type)**
Instructions for advanced operations in English.
- **CI-V Reference guide (PDF type)**
Describes the control commands used in remote control operation (serial communication with CI-V) in English.

For Reference

- **HAM Radio Terms (PDF type)**
A glossary of HAM radio terms in English.

TRADEMARKS

Icom and the Icom logo are registered trademarks of Icom Incorporated (Japan) in Japan, the United States, the United Kingdom, Germany, France, Spain, Russia, Australia, New Zealand, and/or other countries.

The terms HDMI, HDMI High-Definition Multimedia Interface, HDMI Trade dress and the HDMI Logos are trademarks or registered trademarks of HDMI Licensing Administrator, Inc.



All other products or brands are registered trademarks or trademarks of their respective holders.

This product includes RTOS "RTX" software, and is licensed according to the software license.

This product includes "zlib" open source software, and is licensed according to the open source software license.

This product includes "libpng" open source software, and is licensed according to the open source software license.

This product includes "mbed TLS" open source software, and is licensed according to the open source software license.

This product includes "FreeType library" open source software, and is licensed according to the open source software license.

Refer to the "ABOUT THE LICENSES" page at the end of the manual in English for information on the "RTX," "zlib," "libpng," and "mbed TLS" open source software.

ABOUT THE INSTRUCTIONS

The Advanced and Basic manuals are described in the following manner.

“ ” (Quotation marks):

Used to indicate icons, setting items, and screen titles displayed on the screen.

The screen titles are also written in uppercase letters. (Example: FUNCTION screen)

[] (brackets):

Used to indicate keys.

Routes to the Set modes and Setting screens

Routes to the Set mode, Setting screens, and the setting items are described in the following manner.

MENU » SET > Time Set > Date/Time > Date

Instruction example:

◇ Setting the date

1. Open the “Date” screen.

MENU » SET > Time Set > Date/Time > Date

2. Touch [+] or [-] to set the date.

Detailed instruction:

1. Push **MENU**.

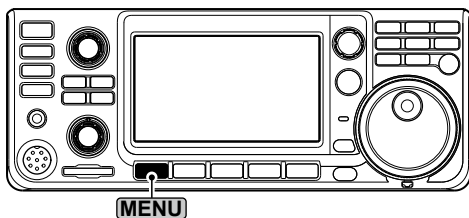

2. Touch [SET].



3. Touch [▲] or [▼] to scroll through the items.
① You can also rotate **MULTI** to scroll through the items.



4. Touch “Time Set.”

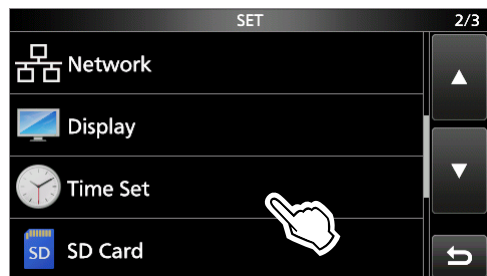

5. Touch “Date/Time.”

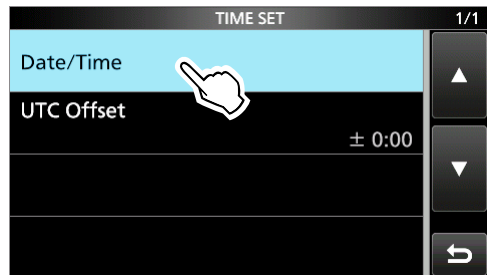

6. Touch “Date.”

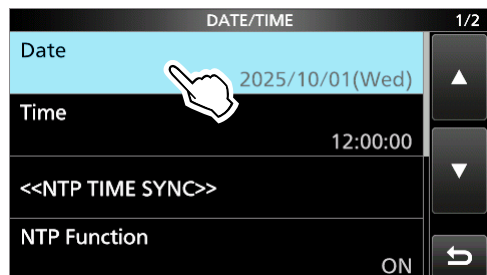

- Opens the “Date” screen.

KEYBOARD ENTERING AND EDITING

Keyboard types:

You can select the Full Keyboard or the Tenkey pad in "Keyboard Type" on the FUNCTION set screen. (p. 54)

MENU » SET > Function > **Keyboard Type**

① You can also temporarily switch the type in the QUICK MENU screen by pushing **QUICK**.

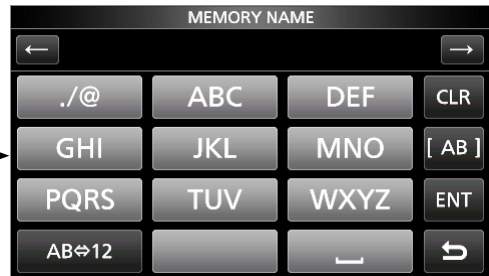
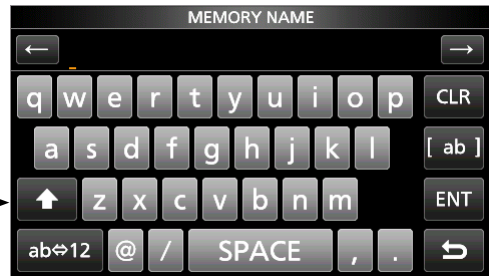
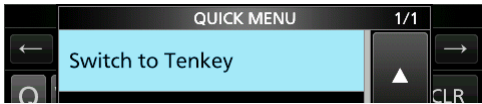
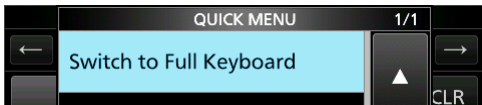

① You can select the full keyboard layout in "Full Keyboard Layout" on the FUNCTION set screen. (p. 54)

MENU » SET > Function > **Full Keyboard Layout**

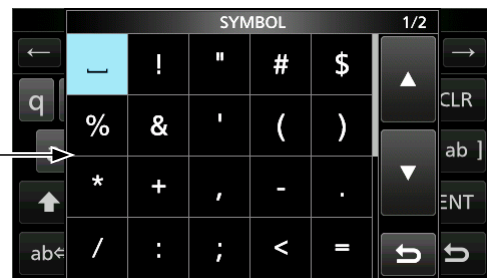
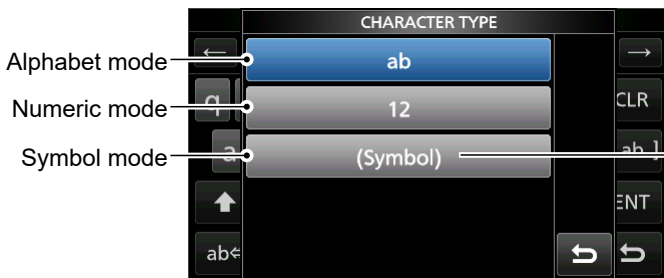
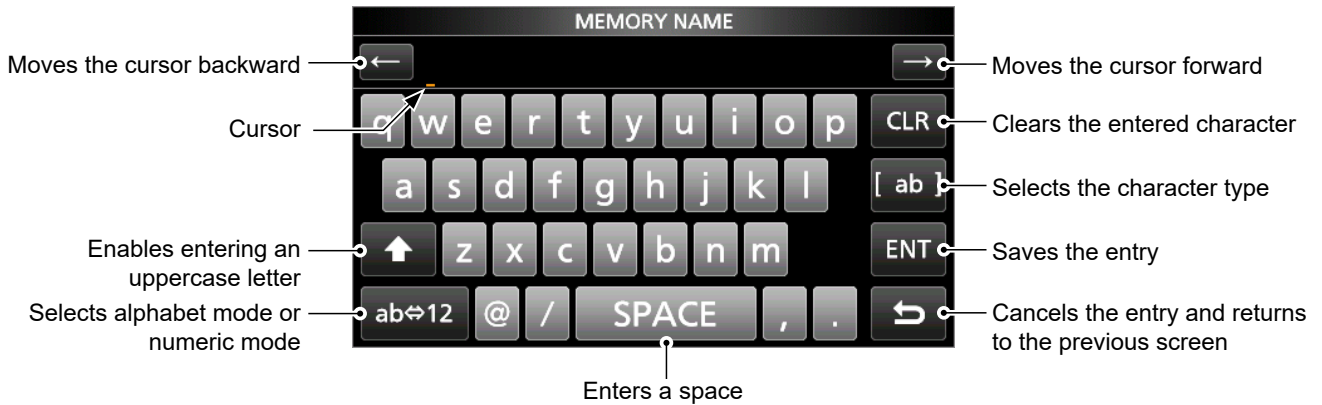

USABLE CHARACTERS

You can enter and edit the items in the following table.

Menu	Category	Item	Selectable characters	Maximum characters
SET	Network	Network Name	A to Z, 0 to 9, - _	15
		Network User 1/2 ID	[AB] [ab] [12] [!"#]	16
		Network User 1/2 Password	① Illegal characters: \ (space)	16*
		Network Radio Name	[AB] [ab] [12] [!"#] ① Illegal character: \	16
	Display	My Call	A to Z, 0 to 9, / @ - . (space)	10
	Time Set	NTP Server Address	A to Z, a to z, 0 to 9, - .	64
	SD Card	Save Setting	[AB] [ab] [12] [!"#] ① Illegal characters: / : ; * < > \	15
KEYER		KEYER MEMORY	A to Z, 0 to 9, / ? ^ . , @ (space) ① "*" (asterisk) has its unique use.	70
RTTY DECODE		RTTY MEMORY	A to Z, 0 to 9, ! \$ & ? " ' - / . , ; ; () ↵ ① "*" (asterisk) has its unique use.	70
VOICE		VOICE TX RECORD	[AB] [ab] [12] [!"#]	16
MEMORY		MEMORY NAME	[AB] [ab] [12] [!"#]	16
PRESET		Preset Name	[AB] [ab] [12] [!"#]	16

* Minimum of 8 characters

[AB]: A to Z, (space)

[ab]: a to z, (space)

[12]: 0 to 9, (space)

[!"#]: ! " # \$ % & ' () * + , - . / : ; < = > ? @ [\] ^ _ ` { | } ~ (space)

TABLE OF CONTENTS

IMPORTANT	2	Setting the frequency	24
FEATURES	2	◇ Using the Main Dial	24
SUPPLIED ACCESSORIES	2	◇ About the Quick Tuning Step	24
EXPLICIT DEFINITIONS	2	◇ Changing the Tuning Step	24
FCC INFORMATION	3	◇ About the 1 Hz step Fine Tuning function	24
DISPOSAL	3	◇ About the 1/4 Tuning function	24
ABOUT CE AND DOC	3	◇ About the Auto Tuning Step function	24
ABOUT UKCA DOC	3	◇ Directly entering a frequency	25
ABOUT SPURIOUS SIGNALS	4	RF gain and SQL level	26
ABOUT THE TOUCH SCREEN	4	Dial Lock function	27
◇ Touch operation	4	Basic transmission	27
◇ Touch screen precautions	4	Adjusting the microphone gain	27
◇ Touch screen maintenance	4	Adjusting the transmit output power	27
ABOUT THE MANUALS	4	Meter display	28
TRADEMARKS	4	◇ Meter display selection	28
ABOUT THE INSTRUCTIONS	5	◇ Multi-function meter	28
KEYBOARD ENTERING AND EDITING	6	Switching the receive antenna connectors	28
USABLE CHARACTERS	7	4 RECEIVING AND TRANSMITTING	29
PRECAUTIONS	10	Preamplifiers	29
INSTALLATION NOTES	11	Attenuator	29
1 PANEL DESCRIPTION	12	RIT function	29
Front panel	12	◇ RIT monitor function	29
Rear panel	14	AGC function control	30
Touch screen display	15	◇ Selecting the AGC time constant preset value ..	30
◇ MENU screen	17	◇ Setting the AGC time constant	30
◇ MENU SET screen	17	Setting the Speech Compressor	31
◇ QUICK MENU screen	17	◇ Setting before using the Speech Compressor	31
◇ FUNCTION screen	17	function	31
◇ Multi-function menus	18	◇ Using the Speech Compressor function	31
Multi-function dial	18	Using the Digital Twin PBT	32
2 INSTALLATION AND CONNECTIONS	19	Selecting the IF filter	33
Selecting a location	19	Selecting the IF filter shape	33
Using the desktop stand	19	Noise Blanker	34
Heat dissipation	19	◇ Adjusting the NB level and time	34
Grounding	19	Noise Reduction	34
Connecting an external DC power supply	20	◇ Adjusting the Noise Reduction level	34
Connecting the antenna tuner	20	Notch Filter	35
Linear amplifier connections	21	◇ Selecting the Notch filter type	35
◇ Connecting an Icom linear amplifier	21	◇ Setting the Manual Notch filter	35
◇ Connecting a non-Icom linear amplifier	21	Setting the transmit filter width	35
3 BASIC OPERATION	22	Split frequency operation	36
When first applying power	22	◇ Using the Quick Split function	36
Turning power ON or OFF	22	◇ Using the receive and transmit frequencies	36
Adjusting the volume level	22	set to VFO A and VFO B	36
Selecting the mode	22	Split Lock function	37
Using the VFO mode	22	IP Plus function	37
◇ Selecting VFO A or VFO B	22	Monitor function	37
◇ Equalizing VFO A and VFO B	22		
Selecting the operating band	23		
Selecting the operating mode	23		

Operating CW.....	38	9 CLOCK.....	64
◇ Setting the CW pitch control.....	38	Setting the date and time	64
◇ Setting the key speed.....	38	◇ Setting the date	64
◇ Using the Break-in function	38	◇ Setting the current time	64
◇ Monitoring the CW side tone.....	39	◇ Setting the UTC offset.....	64
◇ CW Auto Tuning function.....	39	10 MAINTENANCE.....	65
◇ Audio Peak Filter (APF) operation.....	39	Cleaning	65
◇ About the Electronic Keyer function	40	Replacing fuses.....	65
5 SCOPE OPERATION.....	41	Resetting	66
Spectrum scope screen.....	41	◇ Partial reset	66
◇ Using the Spectrum Scope.....	41	◇ All reset	66
◇ Center mode.....	42	Troubleshooting.....	67
◇ Fixed mode.....	42	11 SPECIFICATIONS	70
◇ Scroll mode	42	◇ General.....	70
◇ Marker	42	◇ Transmitter	70
◇ Touch screen operation.....	43	◇ Receiver	71
◇ Mini scope screen	43	◇ Antenna tuner.....	71
Audio scope screen.....	43	12 OPTIONS	72
◇ Using the Audio Scope.....	43	Options	72
6 SD CARD	44	Mounting the MB-118	73
About the SD cards	44	Attaching the MB-123.....	73
Saving data	44	13 CONNECTOR INFORMATION	74
Inserting.....	44	[ACC].....	74
Formatting	45	◇ OPC-599 ACC conversion cable pin	
Unmounting.....	45	assignments	75
7 ANTENNA TUNER OPERATION	46	[MIC].....	75
About the internal antenna tuner.....	46	◇ External keypad.....	75
◇ Using the Internal antenna tuner.....	46	[DC 13.8 V].....	76
◇ Manual tuning.....	46	[ANT]	76
◇ PTT Tuner start	46	[RX-ANT IN]/[RX-ANT OUT].....	76
About the external antenna tuner.....	47	[HDMI]	76
◇ Using the AH-730 or AH-740.....	47	[LAN]	76
◇ Using the IC-PW2.....	47	[EXT-SP].....	76
◇ Using an external antenna tuner	47	[REMOTE]	76
Emergency mode (Tuner).....	48	[USB]	77
8 SET MODE.....	49	[KEY]	77
Set mode description.....	49	[PHONES]	77
Tone Control/TBW	50	[TUNER].....	77
CW-KEY Set.....	50	[SEND]	77
Function.....	51	[ALC]	77
Connectors	56	INDEX.....	78
Network	59	ABOUT THE LICENSES	80
Display.....	60		
Time Set	62		
SD Card.....	62		
Others.....	63		

PRECAUTIONS

⚠ **DANGER HIGH RF VOLTAGE! NEVER** touch an antenna, an antenna connector, or a ground terminal while transmitting. This could cause an electrical shock or burn.

⚠ **DANGER! NEVER** operate the transceiver near unshielded electrical blasting caps or in an explosive atmosphere. This could cause an explosion and death.

⚠ **WARNING RF EXPOSURE!** This transceiver emits Radio Frequency (RF) energy. Extreme caution should be observed when operating this transceiver. If you have any questions regarding RF exposure and safety standards please refer to the Federal Communications Commission Office of Engineering and Technology's report on Evaluating Compliance with FCC Guidelines for Human Radio Frequency Electromagnetic Fields (OET Bulletin 65).

⚠ **WARNING! NEVER** operate the transceiver with earphones, a headset, or other audio accessories at high volume levels. If you experience a ringing in your ears, reduce the volume or discontinue use.

⚠ **WARNING! NEVER** apply AC power to the [DC 13.8 V] socket on the transceiver rear panel. This could cause a fire or damage the transceiver.

⚠ **WARNING! NEVER** apply more than 16 V DC to the [DC 13.8 V] socket on the transceiver rear panel. This could cause a fire or damage the transceiver.

⚠ **WARNING! NEVER** reverse the DC power cable polarity. This could cause a fire or damage the transceiver.

⚠ **WARNING! NEVER** remove the fuse holder on the DC power cable. Excessive current caused by a short could cause a fire or damage the transceiver.

⚠ **WARNING! NEVER** let metal, wire or other objects contact the inside of the transceiver, or make incorrect contact with connectors. This could cause an electric shock or damage the transceiver.

⚠ **WARNING! NEVER** operate or touch the transceiver with wet hands. This could cause an electric shock or damage to the transceiver.

⚠ **WARNING! NEVER** operate the equipment if you notice an abnormal odor, sound or smoke. Immediately turn OFF the power and/or remove the DC power cables. Contact your Icom dealer or distributor for advice.

⚠ **WARNING! NEVER** put the transceiver on an unstable place where the transceiver may suddenly move or fall. This could cause an injury or damage the transceiver.

⚠ **WARNING! NEVER** operate the transceiver during a lightning storm. It may result in an electric shock, cause a fire or damage the transceiver. Always disconnect the power cables and antenna before a storm.

CAUTION: DO NOT expose the transceiver to rain, snow or any liquids. They could damage the transceiver.

CAUTION: DO NOT operate the transceiver unless the antenna and cables are securely attached to the transceiver, and that the antenna and cables are dry before attachment. Exposing the inside of the transceiver to dust or water will result in serious damage to the transceiver.

CAUTION: DO NOT change the internal settings of the transceiver. This could reduce transceiver performance and/or damage to the transceiver. The transceiver warranty does not cover any problems caused by unauthorized internal adjustments.

CAUTION: DO NOT install or place the transceiver in a place without adequate ventilation, or block any cooling vents on the top, rear, sides or bottom of the transceiver or the cooling fan. Heat dissipation may be reduced and damage the transceiver.

CAUTION: DO NOT use harsh solvents such as Benzine or alcohol when cleaning. This could damage the transceiver surfaces. If the surface becomes dusty or dirty, wipe it clean with a soft, dry cloth.

CAUTION: DO NOT use or leave the transceiver in areas with temperatures below -10°C ($+14^{\circ}\text{F}$) or above $+60^{\circ}\text{C}$ ($+140^{\circ}\text{F}$).

CAUTION: DO NOT place the transceiver in excessively dusty environments. This could damage the transceiver.

CAUTION: DO NOT set the transceiver's RF output power to more than a connected linear amplifier's maximum input level. Otherwise, the linear amplifier will be damaged.

CAUTION: DO NOT use non-Icom microphones. Other microphones have different pin assignments, and may damage the transceiver.

CAUTION: DO NOT operate the transceiver if it becomes hot after continuously transmitting for long periods of time. This may damage the transceiver.

DO NOT push PTT unless you actually intend to transmit.

NEVER leave the transceiver in an insecure place to avoid use by unauthorized persons.

Turn OFF the transceiver's power and disconnect the DC power cable when you will not use the transceiver for long period of time.

The LCD display may have cosmetic imperfections that appear as small dark or light spots. This is not a malfunction or defect, but a normal characteristic of LCD displays.

Operate the transceiver that complies with your local laws and regulations.

Depending on countries and/or regions, transceiver's output power and/or operations on specific frequencies may be restricted to avoid interferences with existing radio stations or services.

INSTALLATION NOTES

For amateur base station installations it is recommended that the forward clearance in front of the antenna array is calculated relative to the EIRP (Effective Isotropic Radiated Power). The clearance height below the antenna array can be determined in most cases from the RF power at the antenna input terminals.

As different exposure limits have been recommended for different frequencies, a relative table shows a guideline for installation considerations.

Below 30 MHz, the recommended limits are specified in terms of V/m or A/m fields as they are likely to fall within the near-field region. Similarly, the antennas may be physically short in terms of electrical length and that the installation will require some antenna matching device which can create local, high intensity magnetic fields. Analysis of such MF installations is best considered in association with published guidance notes such as the FCC OET Bulletin 65 Edition 97-01 and its annexes relative to amateur transmitter installations. The EC recommended limits are almost identical to the FCC specified 'uncontrolled' limits and tables exist that show pre-calculated safe distances for different antenna types for different frequency bands. Further information can be found at <https://www.arrl.org/>.

• Typical amateur radio installation

Exposure distance assumes that the predominant radiation pattern is forward and that radiation vertically downwards is at unity gain (sidelobe suppression is equal to main lobe gain). This is true of almost every gain antenna today. Exposed persons are assumed to be beneath the antenna array and have a typical height of 1.8 m.

The figures assume the worst case emission of a constant carrier.

For the bands 10 MHz and higher the following power density limits have been recommended:

10–50 MHz 2 W/sq m

Vertical clearance by EIRP output

1 Watts	2.1 m
10 Watts	2.8 m
25 Watts	3.4 m
100 Watts	5 m
1000 Watts	12 m

Forward clearance by EIRP output

100 Watts	2 m
1000 Watts	6.5 m
10,000 Watts	20 m
100,000 Watts	65 m

In all cases any possible risk depends on the transmitter being activated for long periods. (actual recommendation limits are specified as an average during 6 minutes) Normally the transmitter is not active for long periods of time. Some radio licenses will require that a timer circuit automatically cuts the transmitter after 1–2 minutes etc.

Similarly some types of emission, i.e., SSB, CW, AM etc. have a lower 'average' output power and the assessed risk is even lower.

Front panel

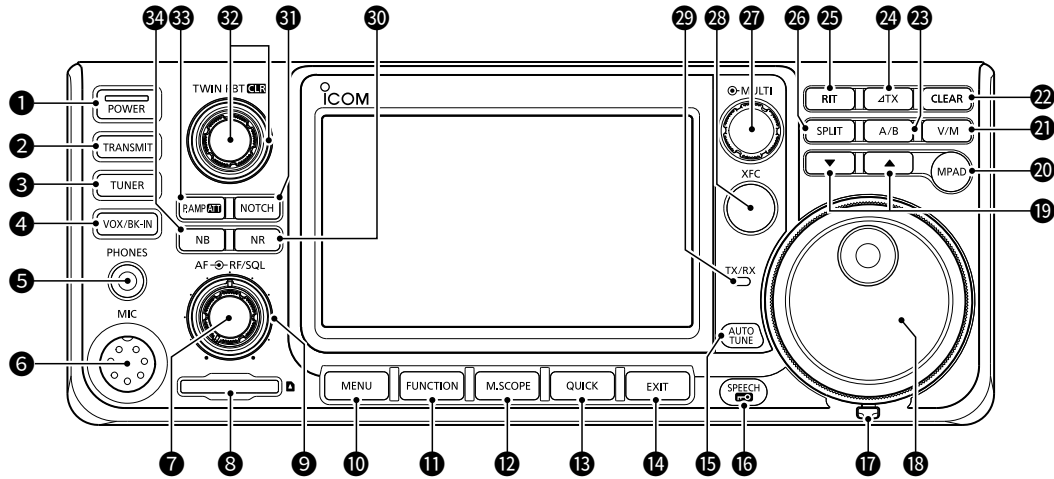
**1 POWER KEY (POWER) (p. 22)**

- Push to turn ON the transceiver.
- Hold down for 1 second to turn OFF the transceiver.

2 TRANSMIT KEY (TRANSMIT) (p. 27)

Push to turn the Transmit function ON or OFF.

3 ANTENNA TUNER KEY (TUNER) (pp. 46, 47)

Push to turn the antenna tuner ON or OFF, or activate the tuner.

4 VOX/BREAK-IN KEY (VOX/BK-IN)

Push to turn the VOX function and the Break-in function in the CW mode (p. 38) ON or OFF.

5 HEADPHONE JACK [PHONES] (p. 77)

Connect to a standard stereo headphone.

6 MICROPHONE CONNECTOR [MIC] (p. 75)

Connect to the supplied or an optional microphone.

7 VOLUME CONTROL (AF-RF/SQL) (p. 22)

Rotate to adjust the audio output level.

8 SD CARD SLOT [SD CARD] (p. 44)

Insert an SD card (user supplied).

9 RF GAIN CONTROL/SQUELCH CONTROL

(AF-RF/SQL) (p. 26)

Rotate to adjust the RF gain and squelch threshold levels.

10 MENU KEY (MENU) (p. 17)

Push to open the MENU screen.

11 FUNCTION KEY (FUNCTION) (p. 17)

Push to open the FUNCTION screen.

12 MINI SCOPE KEY (M.SCOPE) (p. 43)

- Push to display the Mini scope screen.
- Hold down for 1 second to display the Spectrum scope screen.

13 QUICK KEY (QUICK) (p. 17)

Push to open the QUICK MENU screen.

14 EXIT KEY (EXIT)

Push to exit a setting screen or return to the previous screen.

15 AUTO TUNE KEY (AUTO TUNE) (p. 39)

In the CW mode, push to automatically tune the operating frequency to a close-by signal.

16 SPEECH/LOCK KEY (SPEECH)

- Push to announce the receive signal level, operating frequency and mode, depending on the settings.
- Hold down for 1 second to electronically lock **(MAIN DIAL)**. (p. 27)

















17 FRICTION ADJUSTER

Slide to adjust the friction of **(MAIN DIAL)**.

18 MAIN DIAL (MAIN DIAL) (p. 24)

Rotate to change the operating frequency.

Front panel

- 19 MEMORY CHANNEL UP/DOWN KEY**  Push to change the Memory channel.
- 20 MEMO PAD KEY** 
 - Push to sequentially call up the contents in the Memo Pads.
 - Hold down for 1 second to save the displayed contents into the Memo Pad.
- 21 VFO/MEMORY KEY** 
 - Push to switch between the VFO and Memory mode. (p. 22)
 - Hold down for 1 second to copy the memory channel contents to the VFO.
- 22 CLEAR KEY**  Push to clear the RIT or Δ TX shift frequency.
- 23 A/B KEY**  (p. 22)
 - Push to switch between VFO A and VFO B.
 - Hold down for 1 second to copy the selected VFO's frequency, mode, and filter settings to the other VFO.
- 24 Δ TX KEY**  Push to turn the Δ TX function ON or OFF.
- 25 RIT KEY**  (p. 29) Push to turn the Receiver Incremental Tuning (RIT) function ON or OFF.
- 26 SPLIT KEY**  (p. 36) Push to turn the Split function ON or OFF.
- 27 MULTI-FUNCTION CONTROL** 
 - Push to open the Multi-function menu for various adjustments. (p. 18)
 - Rotate to adjust the value that is assigned to . (p. 18)
- 28 TRANSMIT FREQUENCY CHECK KEY** 
 - Hold down to temporarily open the squelch and cancel the noise reduction and RIT function. (p. 29)
 - While the Split or Δ TX function is ON, or using a repeater, hold down to monitor the transmit frequency. (p. 36)
- 29 TX/RX INDICATOR**
 - Lights red while transmitting.
 - Lights green while receiving.
- 30 NOISE REDUCTION KEY**  (p. 34) Push to turn the Noise Reduction function ON or OFF.
- 31 NOTCH KEY**  (p. 35) Push to select the Notch function type.
- 32 TWIN PASSBAND TUNING CONTROL**  (p. 32)
 - Rotate to adjust the IF filter's passband width.
 - Hold down for 1 second to clear the PBT settings.
- 33 PREAMP/ATTENUATOR KEY** 
 - Push to select (and turn ON) one of two receive RF preamplifiers. (p. 29)
 - Hold down for 1 second to turn the Attenuator ON or OFF. (p. 29)
- 34 NOISE BLANKER KEY**  (p. 34) Push to turn the Noise Blanker function ON or OFF.

Rear panel

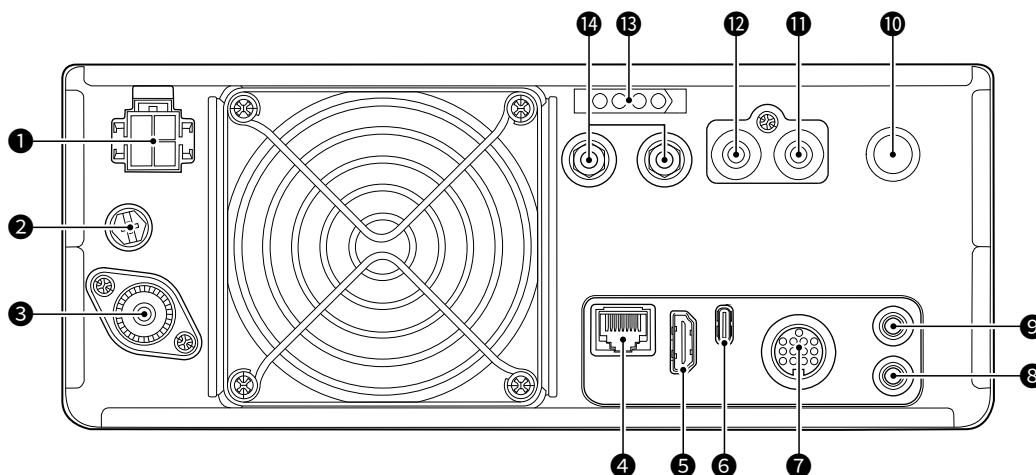

❶ DC POWER SOCKET [DC 13.8 V] (pp. 20, 76)

Connect to a 13.8 V DC source through the supplied DC power cable.

❷ GROUND TERMINAL [GND] (p. 19)

Connect to the ground wire to prevent electrical shocks, TVI, BCI, and other problems.

❸ ANTENNA CONNECTOR [ANT] (p. 76)

Connect to a 50 Ω PL-259 coax connector.

❹ ETHERNET CONNECTOR [LAN] (p. 76)

Connect to a PC network through a LAN.

① Confirm the Network settings before connecting to a network.

❺ HDMI PORT [HDMI] (p. 76)

Connect to an external display monitor or speaker.

① To output the audio from the external display or speaker, set “Audio Output” to “ON.” (p. 61)

When the item is set “ON” and an external display or speaker is connected, the internal speaker is automatically muted.

❻ USB PORT (Type-C) [USB] (p. 77)

Connect to a PC.

❼ ACC SOCKET [ACC] (p. 74)

Connect to devices to control an external unit or to control the transceiver.

❽ CI-V REMOTE CONTROL JACK [REMOTE] (p. 76)

Connect to a PC, a linear amplifier, or other transceiver for remote control.

❾ EXTERNAL SPEAKER JACK [EXT-SP] (p. 76)

Connect to a 4 ~ 8 Ω external speaker with a 3.5 mm (1/8 inch) stereo plug.

❿ KEY JACK [KEY] (p. 77)

Connect to a straight key, a paddle, or an external electronic keyer with a 6.35 mm (1/4 inch) stereo plug.

⓫ SEND JACK [SEND] (p. 77)

Connect to control transmit with non-Icom external units.

⓬ ALC JACK [ALC] (p. 77)

Connect to the ALC output jack of a non-Icom linear amplifier.

⓭ TUNER CONTROL SOCKET [TUNER] (pp. 20, 77)

Connect to the control cable from an optional AH-730 or AH-740 AUTOMATIC ANTENNA TUNER.

⓮ RECEIVE ANTENNA CONNECTORS [RX-ANT IN]/[RX-ANT OUT] (pp. 28, 76)

Connect to an external unit, such as a preamplifier or RF filter, using SMA connectors.

① This is located between the transmit/receive switching circuit and the receiver’s RF stage.

Touch screen display

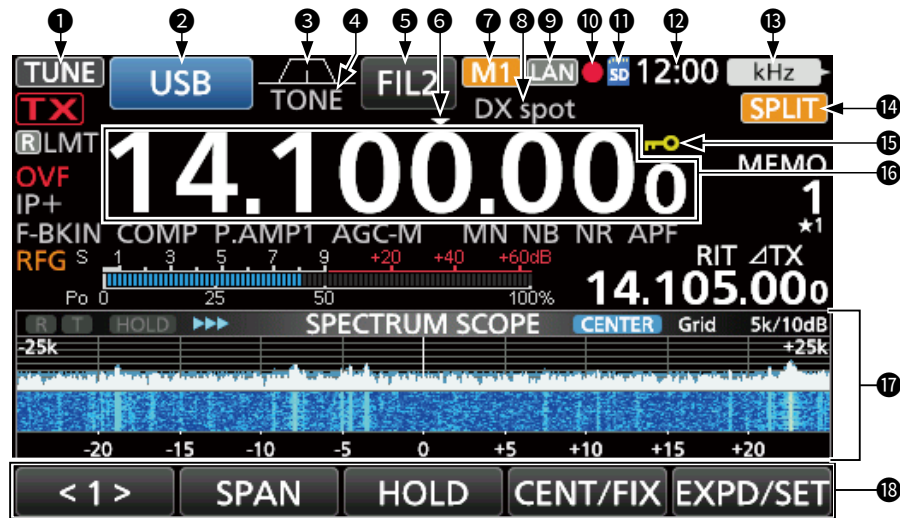

- 1 TUNE ICON** (p. 46)
Displayed while tuning the antenna.
- 2 MODE INDICATOR** (p. 23)
Displays the selected operating mode.
- 3 PASSBAND WIDTH INDICATOR** (p. 32)
Graphically displays the passband width for twin PBT operation and the center frequency for IF shift operation.
① A dot “.” is displayed on the indicator when you change the IF passband width.
- 4 TONE INDICATOR** (p. 32)
Displays the selected tone type in the tone operation mode.
- 5 IF FILTER INDICATOR** (p. 33)
Displays the selected IF filter.
- 6 QUICK TUNING ICON** (p. 24)
Displayed when the Quick Tuning Step function is ON.
- 7 M1~M8/T1~T8 ICON** (p. 24)
• “M1”~“M8” is displayed while “External Keypad” on the CONNECTORS screen is set to “ON,” and using the Memory Keyer function.
• “T1” ~ “T8” is displayed while using the Voice TX memory.
- 8 MEMORY NAME/AUTO TUNE ICON**
• Displayed when the Memory name is entered.
• is displayed when the Auto Tuning function is ON. (p. 39)
- 9 NETWORK CONTROL ICON** (p. 41)
Displayed while accessing the transceiver using the optional RS-BA1, for remote control operation.
- 10 VOICE RECORDER ICONS** (p. 41)
Displayed while recording or pausing using the Voice Recorder.
- 11 SD CARD ICON** (p. 44)
Displayed when an SD card is inserted, or blinks while accessing the SD card.
- 12 CLOCK READOUT** (p. 64)
Displays the current local time.
Touch the readout to display both the current local and UTC times.
- 13 FUNCTION INDICATOR FOR MULTI-FUNCTION CONTROL** (p. 18)
Displays the function that is assigned to .
- 14 SPLIT ICON** (p. 36)
Displayed when the Split function is ON.
- 15 LOCK/1/4 ICONS** (p. 27)
• is displayed while the Lock function is ON. (p. 27)
• is displayed while the 1/4 Tuning function is ON. (p. 24)
- 16 FREQUENCY READOUT** (p. 24)
Displays the operating frequency.
- 17 FUNCTION DISPLAY**
Displayed when an item that has a function display is selected. (Example: Spectrum Scope)
- 18 FUNCTION KEYS** (p. 41)
Displays the function keys.
① Touch to operate the function display (17).

1 PANEL DESCRIPTION

Touch screen display

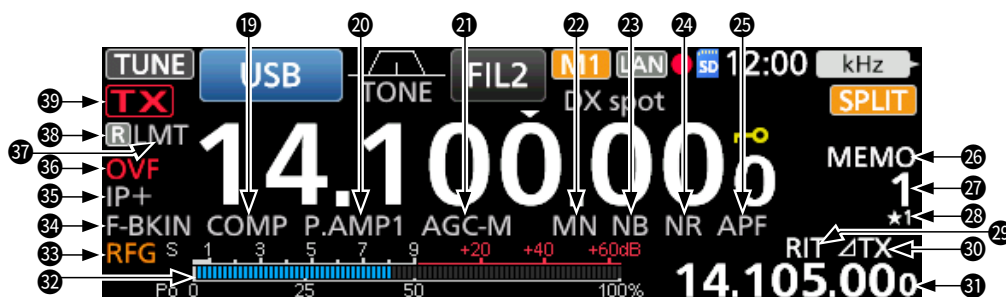

- 19 SPEECH COMPRESSOR ICON (p. 31)**
Displayed when the Speech Compressor function is ON.
- 20 PREAMPLIFIER/ATTENUATOR ICONS (p. 29)**
Displayed when one of the Preamplifiers (P.AMP) or the Attenuator (ATT) is ON.
- 21 AGC ICON (p. 30)**
Displayed while the Auto Gain Control (AGC) is ON.
- 22 NOTCH INDICATOR (p. 35)**
Displayed when the Auto Notch (AN) or Manual Notch (MN) function is ON.
- 23 NOISE BLANKER ICON (p. 34)**
Displayed when the Noise Blanker function is ON.
- 24 NOISE REDUCTION INDICATOR (p. 34)**
Displayed when the Noise Reduction function is ON.
- 25 AUDIO PEAK FILTER ICON (p. 39)**
Displayed when the Audio Peak Filter is ON.
- 26 VFO/MEMORY ICONS (p. 22)**
- “VFO A” or “VFO B” is displayed when the VFO mode is selected.
 - “MEMO” is displayed when the Memory mode is selected.
- 27 MEMORY CHANNEL READOUT 1**
Displays the selected memory channel number.
- 28 SELECT MEMORY CHANNEL ICON ★1**
Indicates that the displayed memory channel is assigned as a Select Memory channel (★1~★3).
- 29 RIT ICON RIT (p. 29)**
Displayed while the RIT function is ON.
- 30 ΔTX ICON ΔTX**
Displayed while the ΔTX function is ON.
- 31 SHIFT FREQUENCY READOUT**
Displays the shift frequency of the RIT (p. 29) or ΔTX functions, while the functions are ON.
- 32 MULTI-FUNCTION METER (p. 28)**
Displays various strengths and levels, depending on the function that you selected.
- 33 RF GAIN ICON RFG (p. 26)**
Displayed when AF (outer) is set counterclockwise from the 11 o'clock position to decrease the RF gain.
- 34 BK-IN/F-BKIN/VOX INDICATORS (p. 38)**
Displayed while the Semi Break-in (BKIN), Full Break-in (F-BKIN), or VOX function is ON.
- 35 IP PLUS ICON (p. 37)**
Displayed when the IP Plus function is ON.
- 36 OVF ICON (p. 26)**
Displayed when an excessively strong signal is received.
- 37 LMT/INH ICONS LMT/INH**
- LMT is displayed if the power amplifier temperature becomes extremely high and the Protection function is activated after transmitting continuously for long periods of time.
 - INH is displayed when the Transmitter Lockout function is activated.
- 38 RX-ANT INDICATOR R (p. 28)**
Displayed when [RX-ANT] is ON.
- 39 TX STATUS INDICATOR (p. 27)**
Displays the transmit status of the displayed frequency.
- TX is displayed on the band used for transmit.
 - TX is displayed while transmitting.
 - TX (with a dotted line) is displayed when the selected frequency is outside of the band edge frequency range.
 - TX (Grayed out) is displayed when transmission is inhibited.

Touch screen display

◇ MENU screen

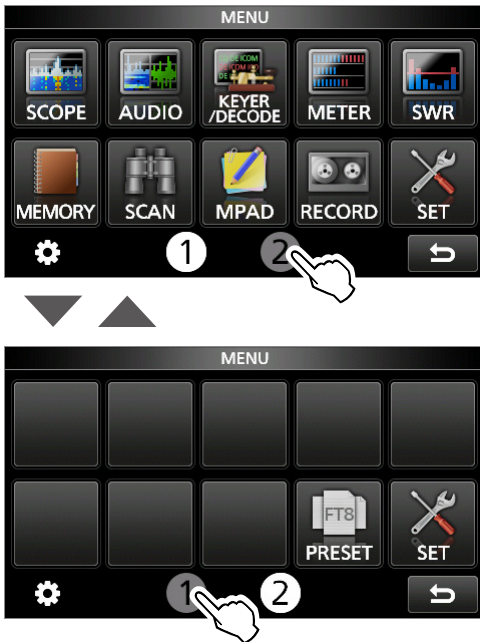

- Push **MENU** to open the MENU screen in the selected mode.
 - ① To close the MENU screen, push **EXIT**.
 - ① Touching [1] or [2] at the bottom of the screen selects MENU screen 1 or 2.

◇ MENU SET screen

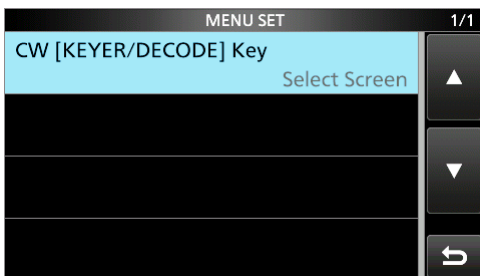

- On the MENU screen, touch to open the MENU SET screen.

◇ QUICK MENU screen

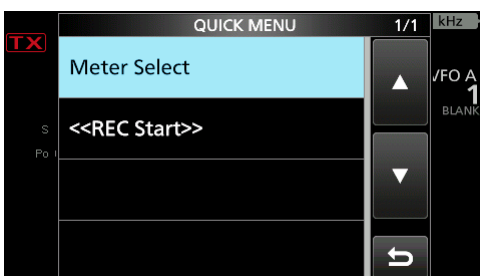

- Push **QUICK** to open the QUICK MENU screen.

◇ FUNCTION screen

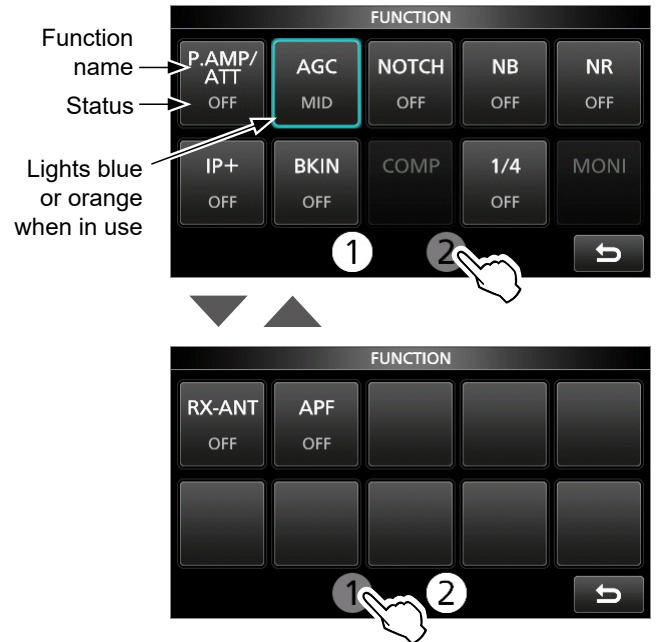

- Push **FUNCTION** to open the FUNCTION screen in the selected mode.
 - ① To close the FUNCTION screen, push **EXIT**.
 - ① Touching [1] or [2] at the bottom of the screen selects FUNCTION screen 1 or 2.

FUNCTION screen list

*1 Touch for 1 second to select the function.
 *2 Touch for 1 second to open its function menu.

P.AMP/ATT	AGC*2	NOTCH*2	NB*2
OFF	FAST	OFF	OFF
P.AMP1	MID	AN	ON
P.AMP2	SLOW	MN	
ATT*1			
NR*2	IP+	VOX*2	BKIN*2
OFF	OFF	OFF	OFF
ON	ON	ON	BKIN
			F-BKIN
COMP*2	TONE*2	TBW	1/4
OFF	OFF	WIDE	OFF
ON	TONE	MID	ON
	TSQL	NAR	
MONI*2	RX-ANT	APF*2	
OFF	OFF	OFF	
ON	ON	ON	

1 PANEL DESCRIPTION

Touch screen display

◇ Multi-function menus



- Push **[MULTI]** (Multi-function control) to open the Multi-function menu.
 - ① You can open other menus by holding down **[NB]**, **[NR]**, **[NOTCH]**, or **[VOX/BK-IN]** for 1 second, or touching a key on the FUNCTION screen.
- While the Multi-function menu is open, touch the desired item and rotate **[MULTI]** to set the desired value.

Multi-function menu items

- *1 Touch the item for 1 second to adjust by rotating **[MULTI]**, even when the Multi-function menu is closed.
- *2 Touch the edge to turn the function ON or OFF, or to adjust the selected item.

SSB	SSB-D	CW	RTTY
RF POWER* ¹	RF POWER* ¹	RF POWER* ¹	RF POWER* ¹
MIC GAIN* ¹	MIC GAIN* ¹	KEY SPEED* ¹	TPF* ²
COMP* ^{1,2}		CW PITCH* ¹	
MONITOR* ^{1,2}	MONITOR* ^{1,2}		MONITOR* ^{1,2}
AM/AM-D	FM/FM-D	NB	NR
RF POWER* ¹	RF POWER* ¹	LEVEL* ¹	LEVEL* ¹
MIC GAIN* ¹	MIC GAIN* ¹	DEPTH* ¹	
		WIDTH* ¹	
MONITOR* ^{1,2}	MONITOR* ^{1,2}		
NOTCH	APF	VOX	BK-IN
POSITION* ¹	POSITION* ¹	GAIN* ¹	DELAY* ¹
WIDTH* ²	WIDTH* ²	ANTI VOX* ¹	
	TYPE* ²	DELAY* ¹	
	AF LEVEL* ¹	VOICE DELAY* ²	

Multi-function dial

When the Multi-function menu is closed, the **[MULTI]** control can be enabled to adjust functions by pushing **[RIT]** or **[ΔTX]**, or touching the item for 1 second on the Multi-function menus.

The function is displayed in the upper right corner of the screen.

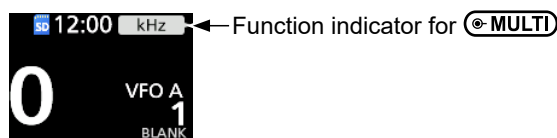

Assignable key functions

- *1 Touch the function indicator, or hold down **[MULTI]** for 1 second to assign the function to the **[MULTI]** control, when the RIT or Δ TX function is OFF.
- *2 On the Multi-function menus, touch the item for 1 second to assign the function to the **[MULTI]** control.

Indicator	Action	
RIT	Rotate	Adjusts the RIT frequency.
	Hold down	Clears the RIT frequency.
Δ TX	Rotate	Adjusts the Δ TX frequency.
	Hold down	Clears the Δ TX frequency.
RIT Δ TX	Rotate	Adjusts the RIT Δ TX frequency.
	Hold down	Clears the RIT Δ TX frequency.
kHz* ¹	Changes the operating frequency in kHz steps. (VFO mode only) Rapidly rotating [MULTI] automatically increases the tuning speed.	
M-CH* ¹	In the Memory mode, selects Memory channels.	
RF PWR* ²	Adjusts the transmit output power.	
MIC G* ²	Adjusts the microphone gain.	
COMP* ²	Adjusts the Speech Compressor level.	
MONI* ²	Adjusts the audio level for the Monitor function.	
SPEED* ²	Adjusts the Keying speed.	
PITCH* ²	Adjusts the CW pitch.	
NB LEV* ²	Adjusts the Noise Blanker level.	
NB DEP* ²	Adjusts the DEPTH (Noise attenuation level).	
NB WID* ²	Adjusts the WIDTH (Blanking duration time).	
NR LEV* ²	Adjusts the Noise Reduction level.	
NOTCH* ²	Adjusts the Notch filter frequency.	
APF* ²	Adjusts the peak frequency of the APF.	
APF LV* ²	Adjusts the audio level of the APF.	
VOX G* ²	Adjusts the VOX gain.	
A-VOX* ²	Adjusts the ANTI VOX level.	
VOX D* ²	Adjusts the VOX delay time.	
BKIN D* ²	Adjusts the Break-in delay time.	

Selecting a location

Select a location for the transceiver that allows adequate air circulation, free from extreme heat, cold, or vibration, and other electromagnetic sources.

Never place the transceiver in areas such as:

- Out of the specified temperature range for the transceiver ($-10^{\circ}\text{C} \sim +60^{\circ}\text{C}$, $+14^{\circ}\text{F} \sim +140^{\circ}\text{F}$).
- An unstable place that slopes or vibrates.
- In direct sunlight.
- High humidity and temperature environments.
- Dusty environments.
- Noisy environments.

Using the desktop stand

The transceiver has a stand for desktop use.

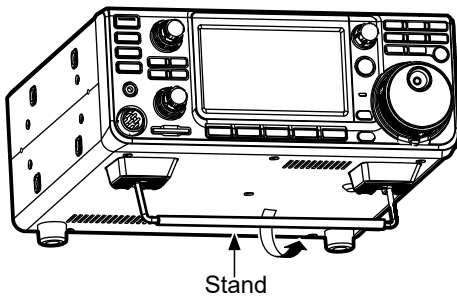

CAUTION: DO NOT hold the stand, dials, and controls when you carry the transceiver. This may damage them.

Heat dissipation

- **NEVER** install the transceiver in a place without adequate ventilation. Heat dissipation may be reduced, and the transceiver may be damaged.
- **DO NOT** place the transceiver against walls or put anything on top of the transceiver. This may block airflow and overheat the transceiver.
- **DO NOT** touch the transceiver after transmitting continuously for long periods of time. The transceiver may become hot.

Grounding

To prevent electrical shock, television interference (TVI), broadcast interference (BCI) and other problems, ground the transceiver using the ground terminal [GND] on the rear panel.

For best results, connect a heavy gauge wire or strap to a long ground rod. Make the distance between the [GND] terminal and the ground as short as possible.

⚠ WARNING! NEVER connect the [GND] terminal to a gas or electric pipe, since the connection could cause an explosion or electric shock.

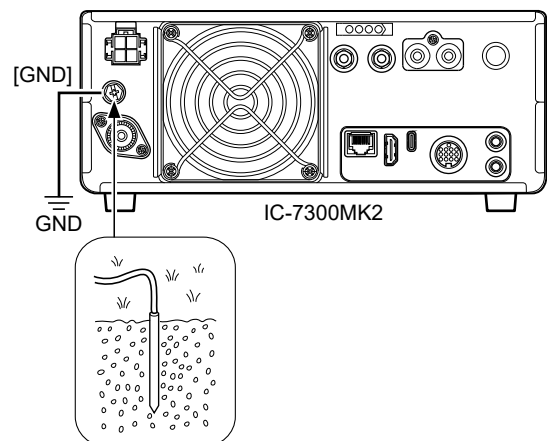

Connecting an external DC power supply

Confirm that the transceiver is OFF before connecting the DC power cable.

① When connecting a non-Icom DC power cable, the transceiver needs:

- 13.8 V DC (Capacity: At least 21 Amps)
- A power supply with an over current protective line, and low voltage fluctuation or ripple.

CAUTION: DO NOT touch the cooling fan on the rear panel of the transceiver after transmitting continuously for long periods of time. The transceiver may become hot.

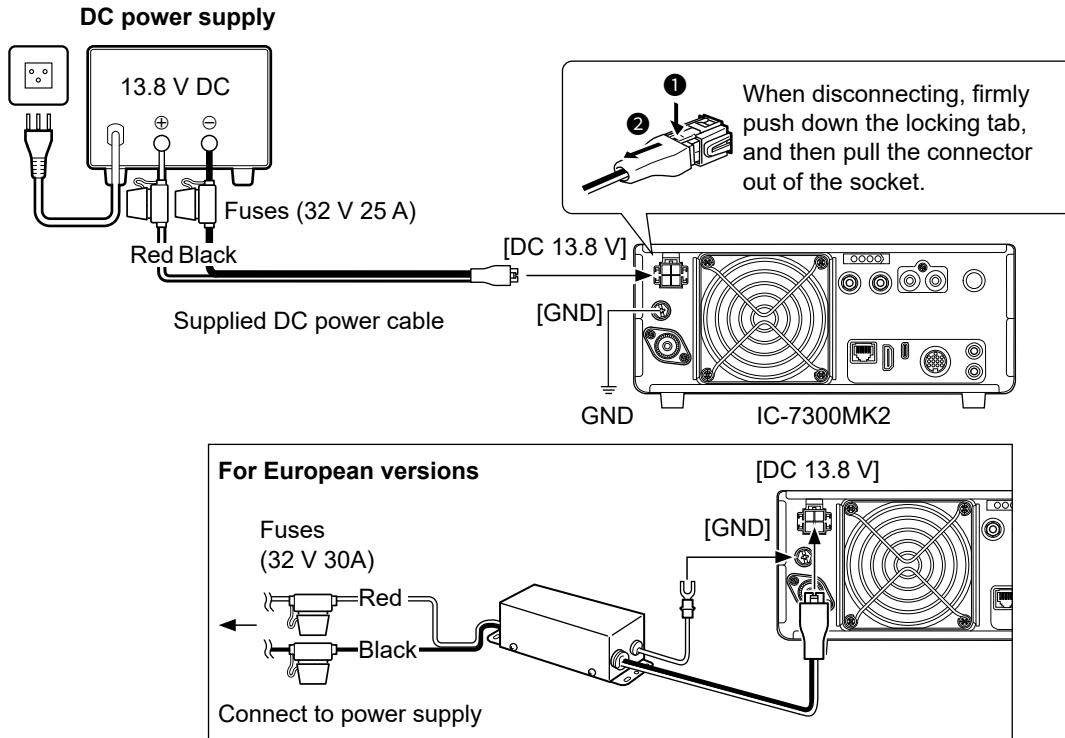

Connecting the antenna tuner

The AH-730 ANTENNA TUNER provides reliable matching from 1.8 to 54 MHz when using at least a 7 m (23 ft) antenna.

NOTE: Before connecting, be sure to turn OFF the transceiver.

- ① See the AH-730 instruction manual for installation and connection details.
- ① While the AH-730 is connected, the internal antenna tuner is deactivated.
- ① See the Advanced manual for connecting the optional AH-740 AUTOMATIC ANTENNA TUNER.

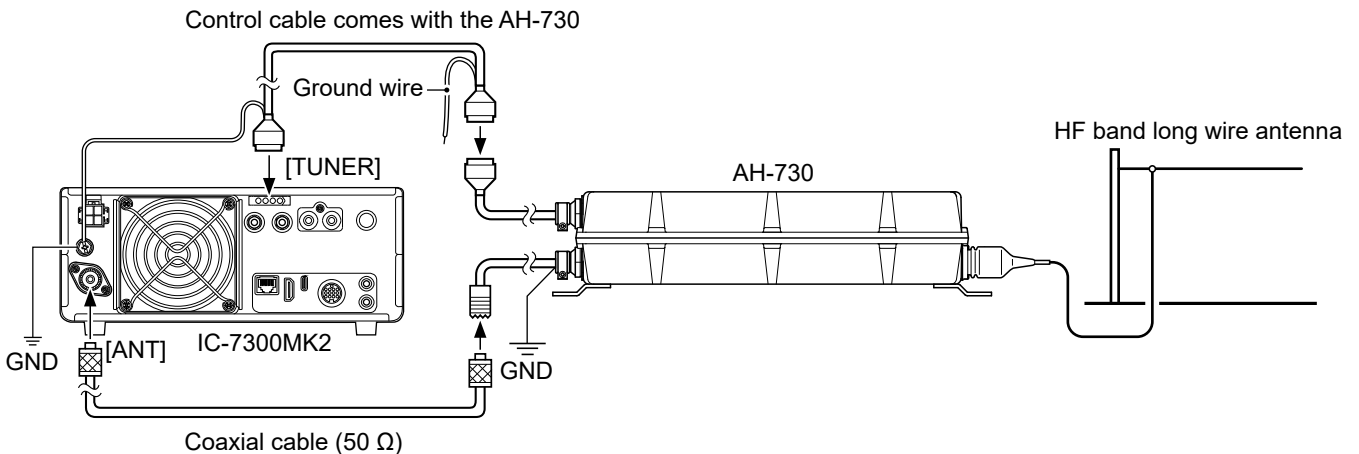

Linear amplifier connections

◇ Connecting an Icom linear amplifier

See the illustration below to connect an Icom linear amplifier. Refer to the amplifier's instruction manual for operation.

Example: Connecting the optional IC-PW2

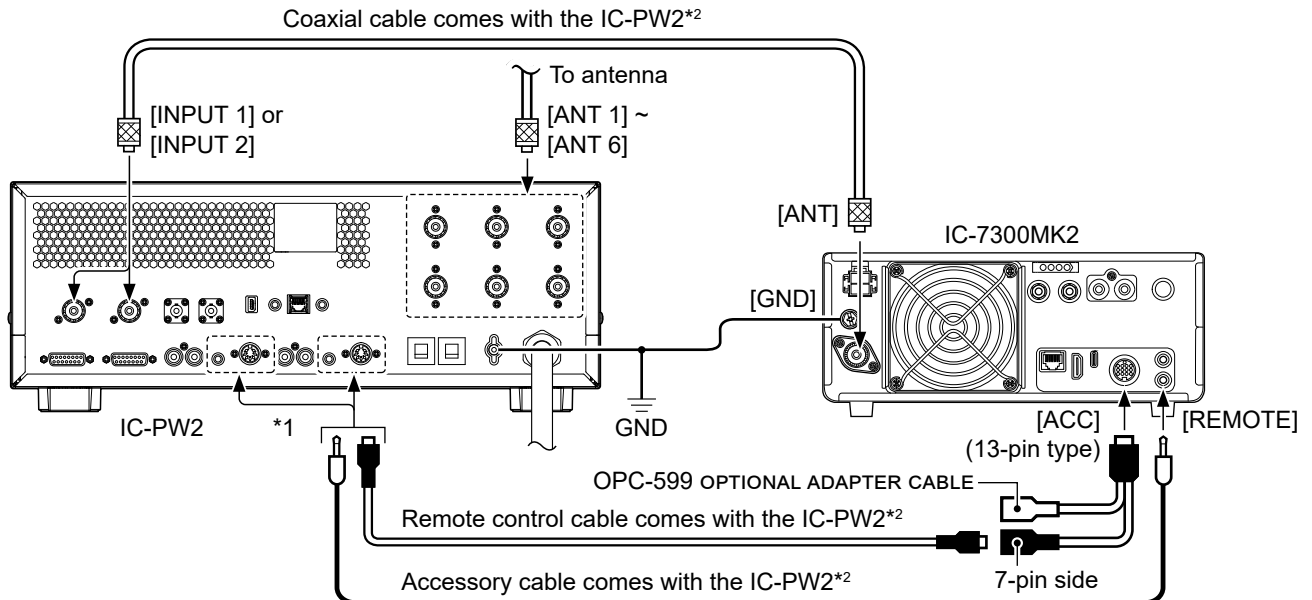

*1 When you connect a coaxial cable to [INPUT 1], connect to [REMOTE 1] and [ACC 1].

When you connect a coaxial cable to [INPUT 2], connect to [REMOTE 2] and [ACC 2].

*2 To connect the second Icom exciter, use the optional OPK-5 CABLE KIT.

◇ Connecting a non-Icom linear amplifier

See the illustration below to connect a non-Icom linear amplifier.

① We recommend that you use a linear amplifier with a specified input power of 100 watts or more. If you use an amplifier with a specified drive level of less than 100 watts, adjust the IC-7300MK2's output power to the specified level before transmitting. Otherwise, the linear amplifier may be damaged.

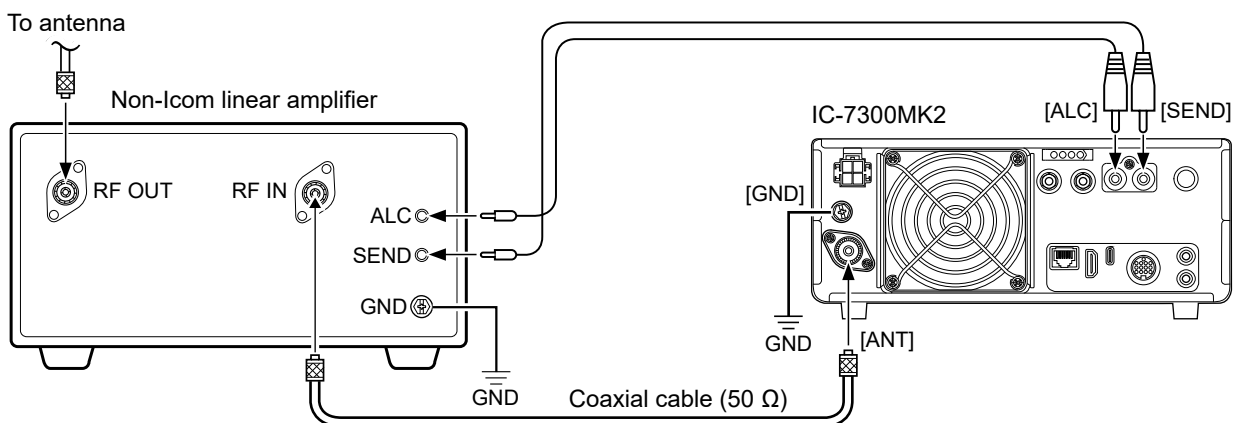

⚠ WARNING!

- The maximum signal level of the [SEND] jack is 16 V/0.5 A DC. Use an external unit if your non-Icom linear amplifier requires a control voltage and/or current greater than specified.
- The ALC input level must be in the range 0 to -6 V. The transceiver does not accept a positive voltage. Non-matched ALC and RF power settings could overheat or damage the linear amplifier.
- When using a linear amplifier such as the IC-PW2, set the RF POWER in the Multi-function menu to keep the ALC meter in the red zone.
 - ① See page 27 for details on the RF POWER.
 - ① See page 28 for details on the ALC zone.

When first applying power

Before turning ON your transceiver for the first time, make sure all connections are correctly made.

After all connections are made, set the dial to the positions described below.

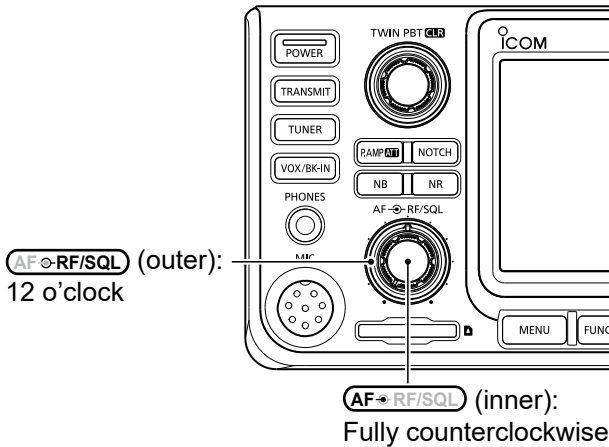

TIP: When you turn OFF the transceiver, it memorizes the current settings. Therefore, when you turn ON the transceiver again, it restarts with the same settings.

Turning power ON or OFF

- To turn ON the transceiver, push **POWER**.
- To turn OFF the transceiver, hold down **POWER** for 1 second until "POWER OFF..." is displayed.

Adjusting the volume level

Rotate **AF-RF/SQ** (inner) to adjust the volume level.

Selecting the mode

VFO mode

Set the desired frequency by rotating **MAIN DIAL**.

Memory mode

Enter contents into the desired channel in the MEMORY list.

Selecting the VFO or Memory mode

- Push **V/M** to select the VFO or Memory mode.

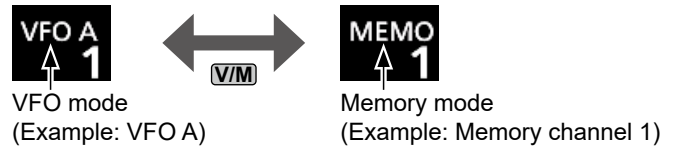

Using the VFO mode

The IC-7300MK2 has 2 Variable Frequency Oscillators (VFO), "A" and "B." Having 2 VFOs is convenient to quickly select 2 frequencies, or for split frequency operation (p. 36). You can use either of the VFOs to operate on a frequency and mode.

◇ Selecting VFO A or VFO B

Push **A/B** to select the VFO A or VFO B.

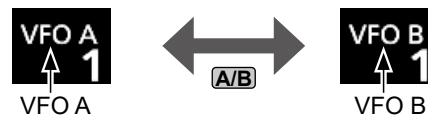

◇ Equalizing VFO A and VFO B

You can set the displayed VFO's frequency to the VFO that is not displayed.

Hold down **A/B** until 2 short beeps sound.

Selecting the operating band

Do the following steps to change the operating band.

1. Touch the MHz digits. (Example: 14)

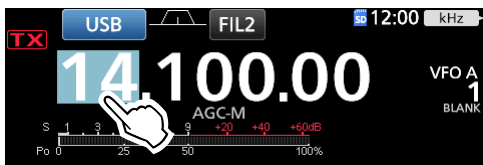

- Opens the BAND STACKING REGISTER screen.

2. Touch a band key. (Example: 21)

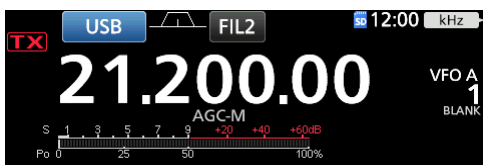
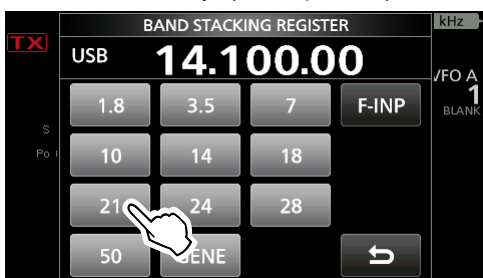

- Displays a 21 MHz frequency.

TIP: About the Band Stacking Register

The Band Stacking Register provides 3 memories for each band. When you change the operating band or the Register, the previously operated frequency and mode are stored.



To display the Band Stacking Register contents:

- Touch the band key for 1 second in step 2.
 - Touch the MHz digits for 1 second on the standby screen.
- ① Touch **[↩]** to return to the previous screen.

Selecting the operating mode

You can select between the SSB (LSB/USB), SSB data (LSB-DATA/USB-DATA), CW, CW reverse, RTTY, RTTY reverse, AM, AM data (AM-DATA), FM, and FM data (FM-DATA) modes.

1. Touch the mode icon (Example: USB).



- Opens the MODE screen.

2. On the MODE screen, touch the desired mode key. (Example: CW).

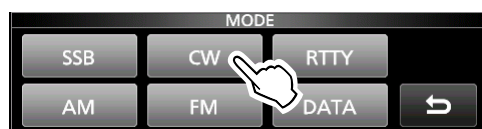

- ① In the SSB, AM, or FM modes, the [DATA] key is displayed.

Operating mode selection list

- ① Touch the mode key to select the operating mode.

Mode key	Operating mode	
[SSB]	LSB	USB
[CW]	CW	CW-R
[RTTY]	RTTY	RTTY-R
[AM]	AM	
[FM]	FM	
[DATA]	LSB	LSB-D
	USB	USB-D
	AM	AM-D
	FM	FM-D

Selecting the Data mode

You can operate data communications (SSTV, RTTY (AFSK), PSK31, JT65B, and FT8).

- ① When a data mode is selected, you can mute the input from the microphone.

[MENU] » **SET > Connectors > MOD Input > DATA MOD**

- ① In the PRESET menu, you can save the combination of the settings for the data mode to quickly change the settings, depending on your operating needs. See the Advanced manual for details.

Setting the frequency

◇ Using the Main Dial

1. Select the desired operating band. (p. 23)
2. Rotate **(MAIN DIAL)**.
 - The frequency changes according to the selected Tuning Step.
 - ① **TX** is displayed when you select an amateur radio frequency, and **TX** (with a dotted line) is displayed when you select a frequency outside a Ham band, or outside your set Band Edges.

◇ About the Quick Tuning Step function

You can set the **(MAIN DIAL)**'s tuning step for each operating mode.

- Touch the kHz digits to turn the Quick Tuning Step function ON or OFF.
- ① The Quick Tuning Step function's icon "▼" is displayed above the 1 kHz digit.

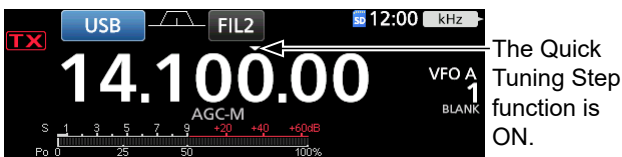
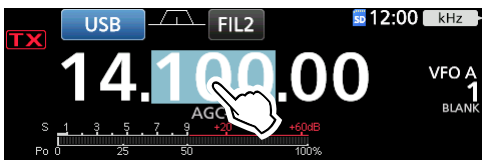

◇ Changing the Tuning Step

When the Quick Tuning Step function is ON, you can change the tuning steps for each operating mode.

1. Select the desired operating mode. (p. 23)
(Example: USB)
2. Touch the kHz digit for 1 second.



- Opens the TS (SSB) screen.
- 3. Touch the desired tuning step. (Example: 0.1 k)

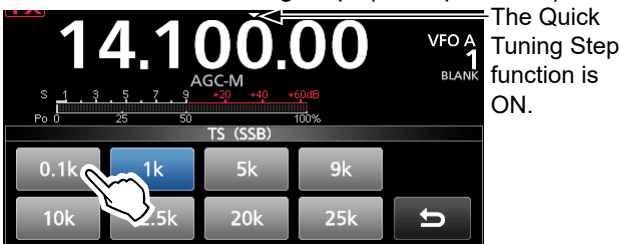

- The tuning step is set, and returns to the previous screen.

◇ About the 1 Hz step Fine Tuning function

You can use the minimum tuning step of 1 Hz for fine tuning.

Touch the Hz digits for 1 second to turn the Fine Tuning function ON or OFF.

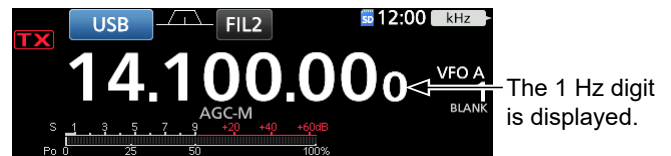
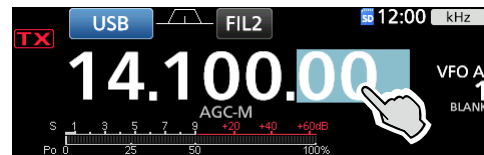

◇ About the 1/4 Tuning function

SSB-D, CW, and RTTY modes

With the Tuning Function OFF, turn ON the 1/4 Tuning function to reduce the tuning speed to 1/4 of the normal speed, for finer tuning.

1. Push **(FUNCTION)**.
 - Opens the FUNCTION screen.
2. Touch [1/4].

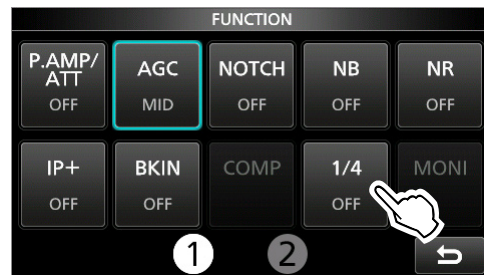

3. Push **(EXIT)**.



◇ About the Auto Tuning Step function

The tuning step automatically changes, depending on the rotation speed of **(MAIN DIAL)**.

① You can change the Auto Tuning Step function settings in the following menu. (p. 53)

(MENU) » **SET > Function > MAIN DIAL Auto TS**

Setting the frequency

◇ Directly entering a frequency

You can set the frequency without rotating (MAIN DIAL) by directly entering it using the keypad.

Entering the operating frequency

1. Touch the MHz digits. (Example: 14)
 - Opens the BAND STACKING REGISTER screen.
2. Touch [F-INP].

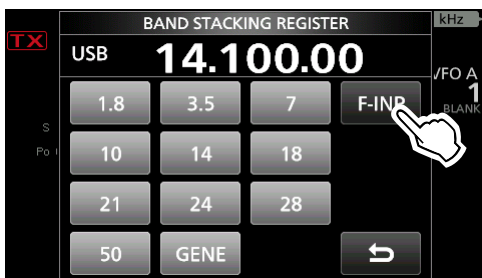

• Opens the F-INP screen.

3. Start entry with the most significant digit.



① To clear the entry, touch [CE].

① To clear the entry and return to the previous screen, push [EXIT].

4. Touch [ENT] to set the entered frequency. Closes the F-INP screen.

① If you touch [ENT] when the digits under 100 kHz are not entered, "0" will be automatically entered into the blank digits.

Entry examples

- 14.025 MHz: [1], [4], [•(-)], [0], [2], [5], [ENT]
- 18.0725 MHz: [1], [8], [•(-)], [0], [7], [2], [5], [ENT]
- 730 kHz: [0], [•(-)], [7], [3], [ENT]
- 5.1 MHz: [5], [•(-)], [1], [ENT]
- 7 MHz: [7], [ENT]
- Changing from 21.28 MHz to 21.245 MHz: [•(-)], [2], [4], [5], [ENT]

① Touching [•(-)] first enters the same MHz digits as the operating frequency.

Entering the Split Frequency Offset

1. Touch the MHz digits. (Example: 14)
 - Opens the BAND STACKING REGISTER screen.
2. Touch [F-INP].

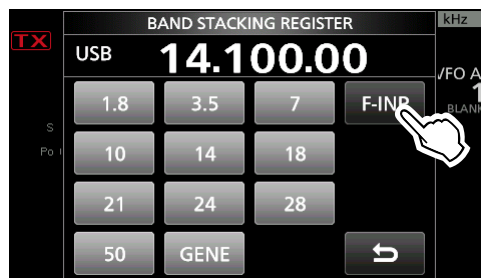

• Opens the F-INP screen.

3. Enter the Split Frequency Offset.



[SPLIT] or [-SPLIT] is displayed.

① Information

- If you want the minus shift direction, touch [•(-)].
- Enter the offset between -9.999 MHz and +9.999 MHz (1 kHz steps).
- To clear the entry, touch [CE].
- To clear the entry and return to the previous screen, push [EXIT].
- After entering, the Split function is automatically turned ON.

4. To save the entry, touch [SPLIT] or [-SPLIT].
 - Closes the F-INP screen.

Entry examples

- 5 kHz: [5], [SPLIT]
- -10 kHz: [•(-)], [1], [0], [-SPLIT]

NOTE: If the entered operating frequency is out of an amateur band's frequency range, the transmit frequency is automatically set to the band edge frequency.

3 BASIC OPERATION

Setting the frequency

◇ Directly entering a frequency

Selecting a Memory channel by number

1. Select the Memory mode. (p. 22)
2. Touch the MHz digits. (Example: 14)



- Opens the BAND STACKING REGISTER screen.
3. Touch [F-INP].

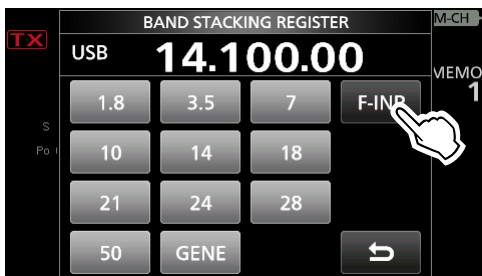

- Opens the F-INP screen.
4. Enter a Memory channel number. (Example: 2)



- ① If you want to set a Program Channel number (P1 or P2), enter "100" for P1 or "101" for P2.
5. Touch [MEMO] to set the memory channel of the entered number.
 - Closes the F-INP screen.
 - The selected memory channel contents are displayed.

RF gain and SQL level

Rotate **(AF/RF/SQL)** (outer) to adjust the RF gain and SQL level.

By default, rotating to the left (when set to the 12 o'clock position) adjusts the RF gain, and rotating to the right adjusts the squelch level, as described below.

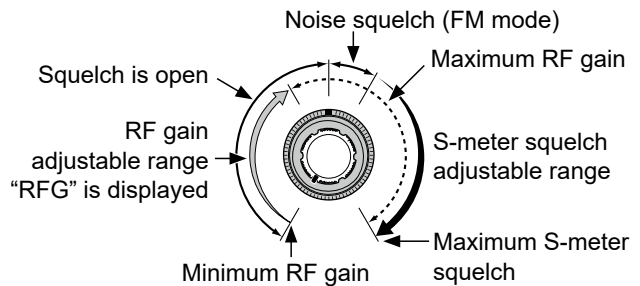

RF gain

You can adjust the receiver sensitivity.

If a strong interfering signal is received, rotate AF **(AF/RF/SQL)** (outer) counterclockwise to reduce the RF gain.

- ① "RFG" is displayed when the RF gain is reduced.
- ① If a strong signal is received and "OVF" (Overflow) is displayed, reduce the RF gain until "OVF" disappears.

Squelch (SQL) level

There are 2 types of SQL levels, depending on the operating mode.

• Noise squelch

Rotate **(AF/RF/SQL)** (outer) until the noise disappears and the TX/RX indicator goes OFF.
 ① Activates only in the FM mode.

• S-meter squelch

The S-meter squelch disables the audio output from the speaker or headphones when the received signal is weaker than the specified S-meter squelch level. Rotate **(AF/RF/SQL)** (outer) clockwise from the 12 o'clock position to increase the S-meter threshold level.

- ① You can change the **(AF/RF/SQL)** (outer) control type in the following setting. (p. 51)

[MENU] » **SET > Function > RF/SQL Control**

Dial Lock function

The Dial Lock function prevents frequency changes caused by accidentally moving **MAIN DIAL**.

① This function electronically locks the dial.

Hold down **[SPEECH LOCK]** for 1 second to turn the Dial Lock function ON or OFF.

- **[LOCK]** is displayed while the function is ON.

② You can select the Dial lock or Panel lock. (p. 53)

[MENU] » **SET > Function > Lock Function**

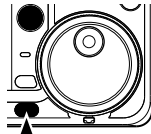

Hold down **[SPEECH LOCK]** for 1 second.

Basic transmission

1. Hold down **[PTT]** (or push **[TRANSMIT]**) to transmit.
 - The TX/RX indicator lights red, and **[TX]** is displayed.
2. Release **[PTT]** (or push **[TRANSMIT]** again).
 - Returns to receive.

Adjusting the microphone gain

1. Set the operating band and mode to SSB, AM, or FM. (p. 23)
2. Push **[MULTI]** to open the Multi-function menu.
3. Hold down **[PTT]** on the microphone.
 - The TX/RX indicator lights red, and **[TX]** is displayed.
4. Touch **[MIC GAIN]**, and rotate **[MULTI]** to adjust the microphone gain.



① Information

- Hold the microphone 5 to 10 cm (2 to 4 inches) from your mouth, then hold down **[PTT]** on the microphone and speak at your normal voice level.
 - In the SSB mode, display the ALC meter and rotate to adjust the microphone gain until the meter reading swings between 30 to 50% of the ALC scale.
 - In the AM or FM mode, check the audio clarity with another station or use the Monitor function (p. 37).
5. Release **[PTT]**.
 - Returns to receive.

Adjusting the transmit output power

Before transmitting, monitor your selected operating frequency to make sure you do not cause interference to other stations on the same frequency. It is a good amateur practice to listen first, and then, even if nothing is heard, ask if the frequency is in use once or twice before you start operating.

1. Select the operating mode. (p. 23)
(Example: USB)
2. Touch the meter, and then touch **[Po]** to display the Po meter. (p. 28)



Po meter

3. Push **[MULTI]** to open the Multi-function menu.
4. Hold down **[PTT]** on the microphone.
 - The TX/RX indicator lights red, and **[TX]** is displayed.
 - The Po meter level changes according to your voice level in the SSB mode. It becomes the S-meter while receiving.
5. Touch **[RF POWER]**, and rotate **[MULTI]** to adjust the transmit output power between 0 and 100% (in 1% steps).

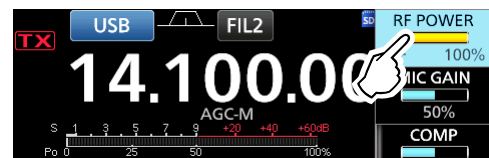

- The Po meter displays the RF output power in percentages. It becomes the S-meter while receiving.
 - ① In the AM mode, the maximum career power is a quarter of the other mode's power.
6. Release **[PTT]**.
 - Returns to receive.

Meter display

◇ Meter display selection

You can display one of the 6 different transmit parameters (Po, SWR, ALC, COMP, Vd, and Id) for your convenience.

1. Touch the displayed parameter.

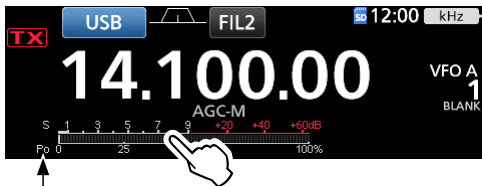

The selected meter's icon is displayed.

- Opens the METER screen.
2. Touch the key to display one of the meters. (Example: SWR).

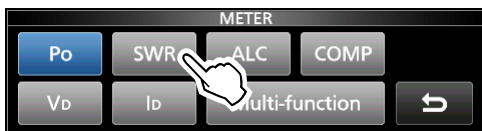

- ① Touching [Multi-function] displays the Multi-function meter.
- ② You can also select the displayed parameter on the QUICK MENU screen.

◇ Multi-function meter

You can simultaneously display all the parameters.

- ① The TEMP meter is also displayed on the Multi-function meter.

Touch the currently displayed parameter for 1 second to display the Multi-function meter.

- ① To close the MULTI-FUNCTION METER screen, push **EXIT**.

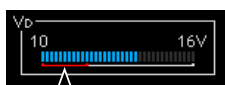
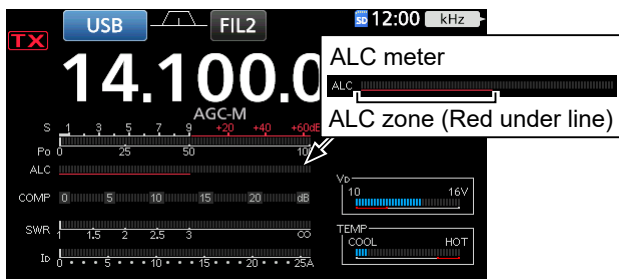

When the Vd meter reads on the red under line or below, the output power may decrease or transceiver power may be shut down.



TX inhibit zone
Displays the temperature of the final amplifier MOS-FETs.

- S:** Displays the receiving signal strength level.
- Po:** Displays the relative RF output power.
- SWR:** Displays the SWR of the antenna at the selected frequency.
- ALC:** Displays the ALC level. When the meter movement shows the input signal level exceeds the allowed level, the ALC limits the RF power. In such case, decrease the microphone gain level.
- COMP:** Displays the compression level when the speech compressor is used.
- Vd:** Displays the drain voltage of the final amplifier MOS-FETs.
- Id:** Displays the drain current of the final amplifier MOS-FETs.
- TEMP:** Displays the temperature of the final amplifier MOS-FETs.

Switching the receive antenna connectors

You can select whether to use the receive antenna connectors ([RX-ANT IN] and [RX-ANT OUT]).

1. Push **FUNCTION**.
 - Opens the FUNCTION screen.
2. Touching [②] at the bottom of the screen to select the FUNCTION screen 2.
3. Touch [RX-ANT].
 - ① Touch [RX-ANT] to turn the receive antenna connectors ([RX-ANT IN] and [RX-ANT OUT]) ON or OFF.

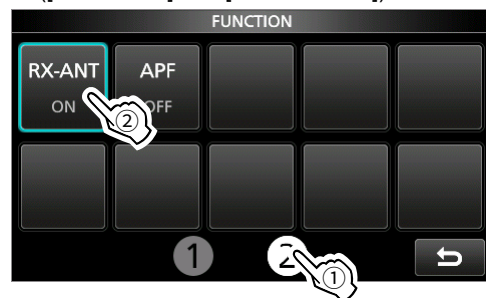

Displayed when [RX-ANT] is ON.

- OFF: Connect the antenna connector to the receiver.
 - ON: Connect the antenna connector to the [RX-ANT OUT], and [RX-ANT IN] to the receiver.
4. To close the FUNCTION screen, push **EXIT**.

Preamplifiers

The preamp amplifies received signals in the receiver front end to improve the signal-to-noise ratio and sensitivity. A preamp is used when receiving weak signals.

① Each band memorizes the Preamplifier setting.

● Push **P.AMP/ATT** (P.AMP).

① Each push changes between “P.AMP1,” “P.AMP2,” and OFF (no icon).



Displayed when the preamp is used.
(Example: P.AMP1)

P.AMP1	Wide dynamic range preamplifier. It is most effective for the HF low bands. • Gain is approximately 12 dB.
P.AMP2	High-gain preamplifier. It is most effective for the higher bands. • Gain is approximately 20 dB.

NOTE: When you use the preamp while receiving strong signals, the receiving signal may be distorted. In such a case, turn OFF the preamp.

Attenuator

The Attenuator prevents a desired signal from becoming distorted when a very strong signal is near your operating frequency, or when a very strong electric field, such as from a broadcasting station, is near your location.

① Each band memorizes the Attenuator setting.

● Hold down **P.AMP/ATT** (ATT) for 1 second to turn ON the Attenuator.

① Pushing **P.AMP/ATT** turns OFF the Attenuator (no icon).

① If a strong signal is received and “OVF” (Overflow) is displayed, turn ON the Attenuator, or decrease the RF gain until “OVF” disappears.



Displayed when the Attenuator is ON.

RIT function

The Receiver Incremental Tuning (RIT) function compensates for differences in frequencies of other stations.

The function shifts your receive frequency up to ± 9.99 kHz without shifting the transmit frequency.

1. Push **RIT**.

• The RIT function turns ON.

① While using the Fine Tuning function (p. 24), the RIT frequency is displayed in 4 digits, instead of 3.

① Pushing **RIT** turns the RIT function ON or OFF.



RIT frequency (3 digits)

2. Rotate **MULTI** to set the RIT frequency to match the received station's transmit frequency.

① You can reset the RIT frequency to “0.00” by holding down **CLEAR** for 1 second.

① You can add the frequency shift to the operating frequency by holding down **RIT** for 1 second.

3. After communicating, push **RIT** to turn OFF the RIT function.

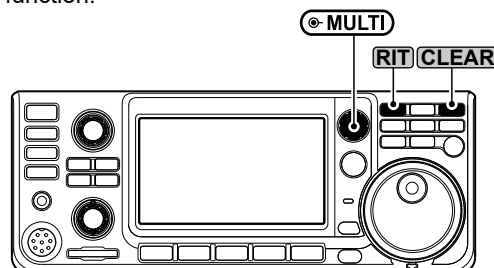

① You can change the **CLEAR** operation.

MENU » SET > Function > Quick RIT/ Δ TX Clear

◇ RIT monitor function

When the RIT function is ON, you can directly monitor the transmit frequency by holding down **XFC**.

① While monitoring:

- The TX/RX indicator lights green.
- The RIT function and the Noise Reduction, Notch filter, and Twin PBT settings are temporarily turned OFF.

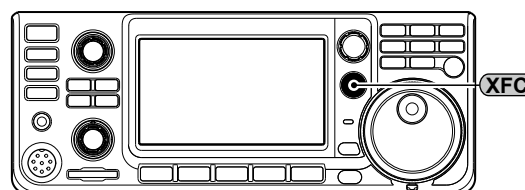

AGC function control

SSB, CW, RTTY, and AM modes

The Automatic Gain Control (AGC) function controls receiver gain to produce a constant audio output level, even when the received signal strength greatly varies.

① Each mode memorizes the AGC setting.

◇ Selecting the AGC time constant preset value

The transceiver has FAST, MID, and SLOW preset AGC settings for all modes, except in the FM mode.

1. Select the operating band and mode.
(Example: SSB, 14 MHz band)
2. Push **FUNCTION**.
• Opens the FUNCTION screen.
3. Touch [AGC] to select the desired time constant.



- ① Touching [AGC] selects FAST, MID, or SLOW.
- ① For the FM mode, FAST is fixed.

4. To close the FUNCTION screen, push **EXIT**.

◇ Setting the AGC time constant

You can set the preset AGC time constant to a desired value.

1. Select the operating band and mode.
(Example: SSB, 14 MHz band)
2. Push **FUNCTION**.
• Opens the FUNCTION screen.
3. Touch [AGC] for 1 second.



- Opens the AGC (SSB) screen.

4. Touch FAST, MID, or SLOW. (Example: MID)

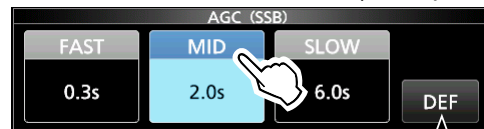

You can reset to the default setting by touching this key for 1 second.

5. Rotate **MAIN DIAL** to set the time constant.
6. To close the AGC (SSB) screen, push **EXIT**.

Selectable AGC Time constant (unit: seconds)

Mode	Default	Adjustable time constant
LSB USB	0.3 (FAST)	OFF, 0.1, 0.2, 0.3, 0.5, 0.8, 1.2, 1.6, 2.0, 2.5, 3.0, 4.0, 5.0, or 6.0
	2.0 (MID)	
	6.0 (SLOW)	
CW/ RTTY	0.1 (FAST)	OFF, 0.1, 0.2, 0.3, 0.5, 0.8, 1.2, 1.6, 2.0, 2.5, 3.0, 4.0, 5.0, or 6.0
	0.5 (MID)	
	1.2 (SLOW)	
AM	3.0 (FAST)	OFF, 0.3, 0.5, 0.8, 1.2, 1.6, 2.0, 5.0, 2.5, 3.0, 4.0, 5.0, 6.0, 7.0, or 8.0
	5.0 (MID)	
	7.0 (SLOW)	
FM	0.1 (FAST)	Fixed

NOTE: While you are receiving weak signals, and a strong signal is momentarily received, the AGC function quickly reduces the receiver gain. When that signal disappears, the transceiver may not receive the weak signal because of the AGC action. In that case, select FAST, or touch [AGC] for 1 second to open the AGC screen, and then select OFF.

Setting the Speech Compressor

SSB mode

The Speech Compressor increases the average RF output power, improving readability at the receiving station. This function compresses the transmitter audio input to increase the average audio output level.

① The function is effective for long-distance communication, or when propagation conditions are poor.

◇ Setting before using the Speech Compressor function

1. Select the SSB mode. (Example: USB)
2. Push **FUNCTION**.
 - Opens the FUNCTION screen.
3. Be sure the Speech Compressor is OFF.
 - ① If the Speech Compressor is ON, touch [COMP] to turn it OFF.

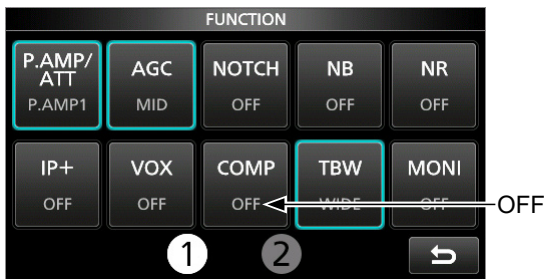

4. Push **EXIT** to close the FUNCTION screen.
5. Touch the meter, and then touch [ALC] to display the ALC meter.



ALC meter

6. Push **MULTI** to open the Multi-function menu.
7. Touch [MIC GAIN], and then rotate **MULTI** to adjust it by speaking into the microphone to where the ALC meter reads within the 30 to 50% range of the ALC zone.

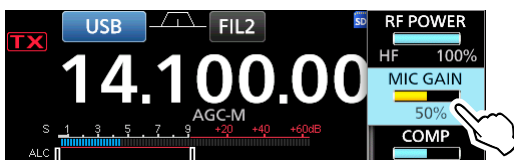

ALC zone

◇ Using the Speech Compressor function

1. Touch the meter, and then touch [COMP] to display the COMP meter.
2. Push **FUNCTION**.
 - Opens the FUNCTION screen.
3. Touch [COMP] for 1 second.



- Turns ON the Speech Compressor function and opens the Multi-function menu.
4. While speaking into the microphone at your normal voice level, rotate **MULTI** to adjust the Speech Compressor level to where the COMP meter reads within the COMP zone (10 to 20 dB range).
- ① If the COMP meter peaks exceed the COMP zone, your transmitted voice may be distorted.

Speech Compressor is ON.

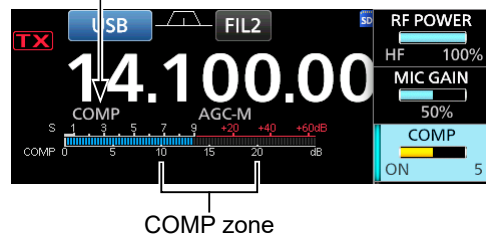

COMP zone

5. To close the Multi-function menu, push **MULTI**.

Using the Digital Twin PBT

SSB, CW, RTTY, and AM modes

To reject interference, the Digital Twin Passband Tuning (PBT) narrows the IF passband width by electronically shifting the IF frequency to slightly above or below the IF center frequency.

The IC-7300MK2 uses the digital function using the DSP (Digital Signal Processor) filtering method.

① Each band memorizes the PBT setting.

- Rotate **TWIN PBT CLR** inner (PBT1) and outer (PBT2) to adjust the shift value.

- The passband width and shift value are displayed.

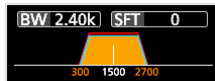

- ① Hold down **TWIN PBT CLR** for 1 second to clear the PBT setting.

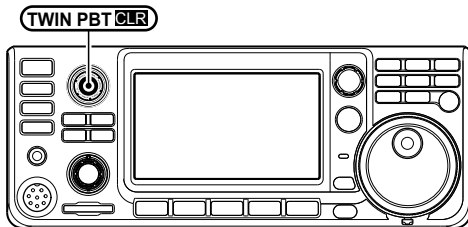

① Information

- To narrow the IF passband width, shift “PBT1” and “PBT2” in the opposite direction from each other, to narrow the overlapped area.
- To use as the IF Shift function, set “PBT1” and “PBT2” to the same value.
- The PBT is adjustable in 50 Hz steps in the SSB, CW, and RTTY modes, and 200 Hz in the AM mode. The center shift value changes in 25 Hz steps in the SSB, CW, and RTTY modes, and 100 Hz in the AM mode.

NOTE: While rotating **TWIN PBT CLR**, you may hear some noise. This comes from the DSP and does not indicate an equipment malfunction.

TIP:

- A dot “.” is displayed on the Passband Width indicator when you change the IF passband width, using the Digital Twin PBT.



- Touch the IF Filter indicator for 1 second to display the current passband width and shift value. Opens the FILTER screen.

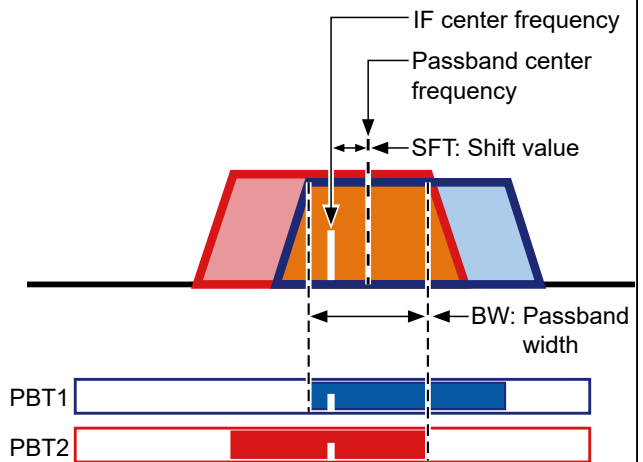
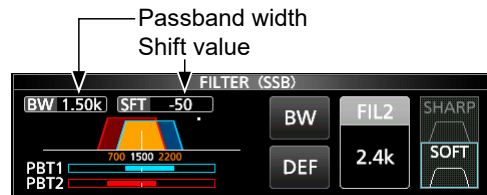

PBT is OFF

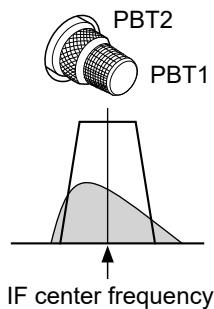

Cutting the lower passband

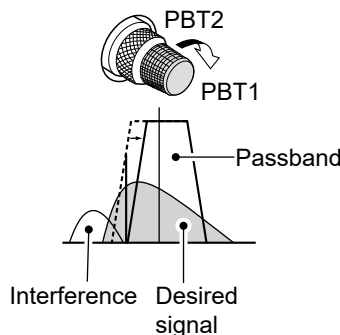

Cutting both higher and lower passbands

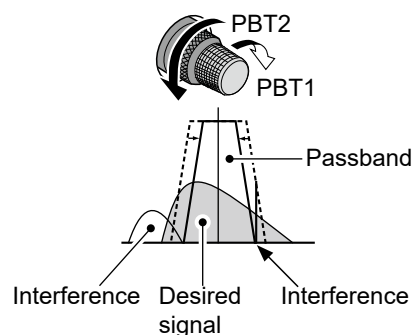

Selecting the IF filter

SSB, CW, RTTY, and AM modes

The IC-7300MK2 has 3 IF filter passband widths for each mode, and you can select them on the FILTER screen.

You can set the IF filter to wide (FIL 1), mid (FIL 2), or narrow (FIL 3).

1. Select the operating mode. (Example: USB)
2. Touch the IF Filter indicator for 1 second.

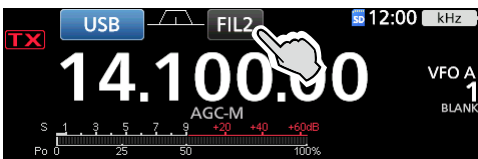

3. Touch the IF Filter indicator several times to select FIL 1 (wide), FIL 2 (mid), or FIL 3 (narrow).
4. Touch [BW].
 - Selects the passband width mode.

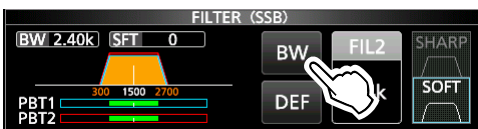

You can reset to the default settings by touching this key for 1 second.

5. Rotate **MAIN DIAL** to select the passband width.
 - ① You cannot change the passband width in the FM or FM-D mode.
 - ① When you change the passband width, the Digital Twin PBT setting value is reset to the center position.
 - ① "BPF" is displayed when a bandwidth is set to 500 Hz or less in the SSB, CW, or RTTY mode.
6. To close the FILTER screen, push **EXIT**.

TIP: When you set the IF filter to FIL2 or FIL3 in the FM mode, the transceiver will transmit in the FM narrow mode.

Mode	IF filter	Selectable range (steps)
SSB	FIL 1 (3.0 kHz)	50 Hz to 500 Hz (50 Hz)/ 600 Hz to 3.6 kHz (100 Hz)
	FIL 2 (2.4 kHz)	
	FIL 3 (1.8 kHz)	
SSB-D	FIL 1 (3.0 kHz)	50 Hz to 500 Hz (50 Hz)/ 600 Hz to 3.6 kHz (100 Hz)
	FIL 2 (1.2 kHz)	
	FIL 3 (500 Hz)	
CW	FIL 1 (1.2 kHz)	50 Hz to 500 Hz (50 Hz)/ 600 Hz to 3.6 kHz (100 Hz)
	FIL 2 (500 Hz)	
	FIL 3 (250 Hz)	
RTTY	FIL 1 (2.4 kHz)	50 Hz to 500 Hz (50 Hz)/ 600 Hz to 2.7 kHz (100 Hz)
	FIL 2 (500 Hz)	
	FIL 3 (250 Hz)	
AM AM-D	FIL 1 (9.0 kHz)	200 Hz to 10.0 kHz (200 Hz)
	FIL 2 (6.0 kHz)	
	FIL 3 (3.0 kHz)	
FM FM-D	FIL 1 (15 kHz)	Fixed
	FIL 2 (10 kHz)	
	FIL 3 (7.0 kHz)	

Selecting the IF filter shape

SSB and CW modes

You can set the IF filter shape for each mode.

1. Select the operating mode. (Example: USB)
2. Touch the filter icon for 1 second.
 - Opens the FILTER (SSB) screen.
3. Touch [SHARP] or [SOFT].

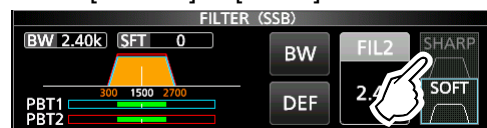

4. To close the FILTER screen, push **EXIT**.

• SHARP

This selection is to emphasize the passband width of the filter. The filter has an almost ideal shape factor. Signals that are out of the passband are extremely filtered out, and it gives you better audio quality.

• SOFT

The filter shoulders are roundly formed as in analog filters. This decreases noise components in the high and low frequencies of the filter passband, and increases the S/N of the target signal. These characteristics play an effective role in picking up very weak signals. The shape factor is retained, and the sharpness of the bandpass is excellent.

Noise Blanker

SSB, CW, RTTY, and AM modes

The Noise Blanker eliminates pulse-type noise, such as the noise from car ignitions.

- Push **[NB]**.
 - ① Pushing **[NB]** turns this function ON or OFF.
 - ① You can also turn the Noise Blanker ON or OFF on the FUNCTION screen.

NOTE: When using the Noise Blanker, received signals may be distorted if they are excessively strong, or the noise is other than a pulse type. In that case, turn OFF the Noise Blanker, or shallow the DEPTH on the NB menu. See the description below for details.

◇ Adjusting the NB level and time

To deal with various types of noise, you can adjust the attenuation level and blanking depth and width in the NB menu.

1. Hold down **[NB]** for 1 second.
 - Turns ON the Noise Blanker and opens the NB menu.
2. Touch the item to adjust. (Example: DEPTH)

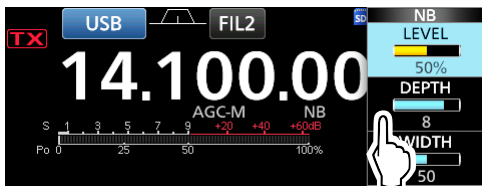

3. Rotate **[MULTI]** to adjust the item. (Example: 8)
4. To close the NB menu, push **[MULTI]**.

LEVEL (Default: 50%)

Adjusts the level where the Noise Blanker activates between 0 and 100%.

DEPTH (Default: 8)

Adjusts the noise attenuation level to between 1 and 10.

WIDTH (Default: 50)

Adjusts the blanking duration time to between 1 and 100.

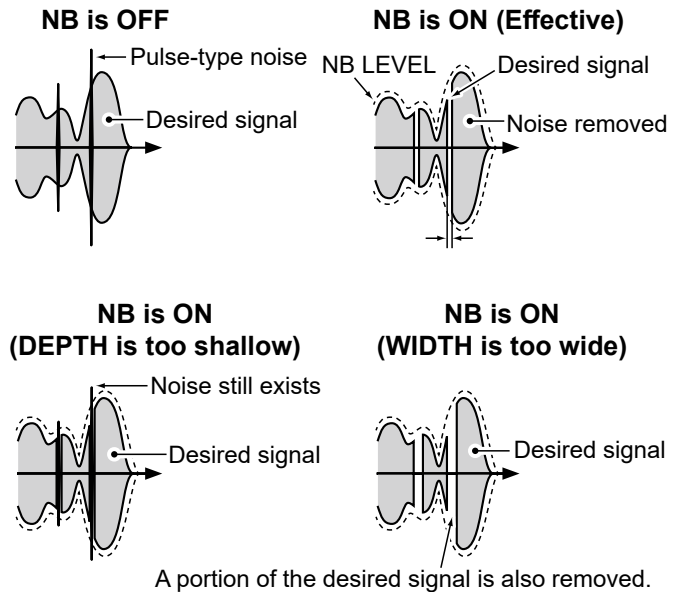

Noise Reduction

The Noise Reduction function reduces random noise components and enhances the signal audio.

- Push **[NR]**.
 - ① Pushing **[NR]** turns this function ON or OFF.
 - ① You can also turn the Noise Reduction ON or OFF on the FUNCTION screen.

◇ Adjusting the Noise Reduction level

Adjust the Noise Reduction level to where the noise is reduced, but the received signal is not distorted.

1. Hold down **[NR]** for 1 second.
 - Turns ON the Noise Reduction function and opens the NR menu.
2. Rotate **[MULTI]** to adjust the Noise Reduction level to between 0 and 15.



- ① Adjust to a higher level to increase the reduction level, and a lower level to decrease it.
3. To close the NR menu, push **[MULTI]**.

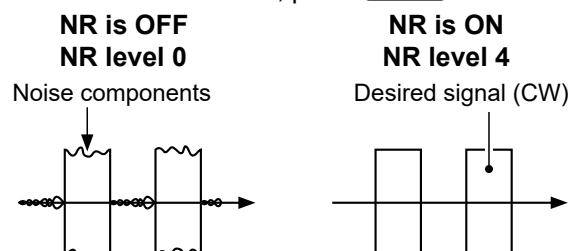

Notch Filter

The IC-7300MK2 has Auto Notch and Manual Notch functions.

Auto Notch automatically attenuates beat tones, tuning signals, and so on. It can be used in the SSB, AM, and FM modes.

Manual Notch attenuates beat tones, tuning signals, and so on by manually adjusting the filtering frequency. It can be used in the SSB, CW, RTTY, and AM modes.

◇ Selecting the Notch filter type

- Push **NOTCH**.

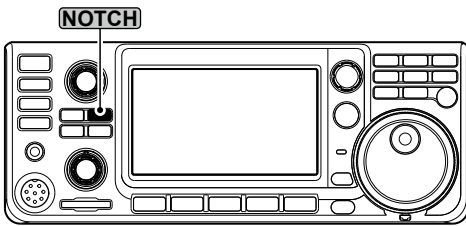

- ① Pushing **NOTCH** changes between “AN (Auto Notch),” “MN (Manual Notch),” and OFF.
- ① You can also select the Notch filter type on the FUNCTION screen.

Displayed when Auto Notch is selected.

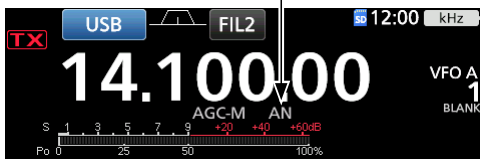

◇ Setting the Manual Notch filter

When Manual Notch is selected, adjust the filtered frequency.

1. Hold down **NOTCH** for 1 second.
 - Opens the NOTCH menu.
 - The Manual Notch is automatically selected, and “MN” is displayed.
2. Touch **[WIDTH]** several times to set the Manual Notch filter width to “WIDE,” “MID,” or “NAR.”

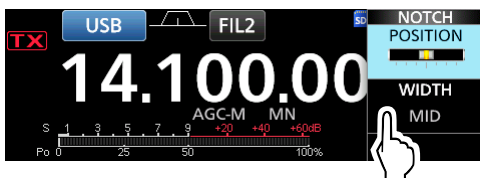

3. Rotate **⊖MULTI** slowly to manually attenuate the frequency.
4. To close the NOTCH menu, push **⊖MULTI**.

NOTE: While adjusting, noise may be heard. This comes from the DSP and does not indicate an equipment malfunction.

Setting the transmit filter width

SSB mode

The transmit filter width for the SSB and SSB-D modes can be set. WIDE (wide), MID (mid), or NAR (narrow) can be selected only in the SSB mode.

To change the filter width in the SSB mode:

1. Set the operating mode to USB or LSB.
2. Push **FUNCTION**.
 - Opens the FUNCTION screen.
3. Touch **[TBW]**.



- ① Touching **[TBW]** changes the filter width between WIDE, MID, and NAR.

The transmit filter widths are set to the following values by default.

- SSB (WIDE): 100 Hz to 2900 Hz
- SSB (MID): 300 Hz to 2700 Hz
- SSB (NAR): 500 Hz to 2500 Hz
- SSB-D: 300 Hz to 2700 Hz

- ① You can change the filter width values in the following settings.

[MENU] » SET > Tone Control/TBW > TX > SSB > **TBW (WIDE)**

[MENU] » SET > Tone Control/TBW > TX > SSB > **TBW (MID)**

[MENU] » SET > Tone Control/TBW > TX > SSB > **TBW (NAR)**



[MENU] » SET > Tone Control/TBW > TX > SSB-D > **TBW**

Split frequency operation

Split frequency operation enables you to transmit and receive on different frequencies in the same or different bands.

There are 2 ways to use the Split frequency operation.

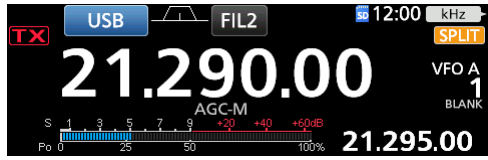
- Use the Quick Split function.
- Use the receive and transmit frequencies set to VFO A and VFO B.

Another station		My station	
Transmit frequency	USB mode 21.29000 MHz	VFO A Receive frequency	
Receive frequency	USB mode 21.29500 MHz	VFO B Transmit frequency	

◇ Using the Quick Split function

The Quick Split function enables you to automatically equalize the frequency and mode of the VFOs to the displayed VFO, and activate the Split function.

1. Set VFO A's receive frequency and operating mode. (Example: 21.29000 MHz in the USB mode)
2. Hold down **[SPLIT]** for 1 second.
 - The Quick Split function is turned ON, and the VFO A settings are set to VFO B.

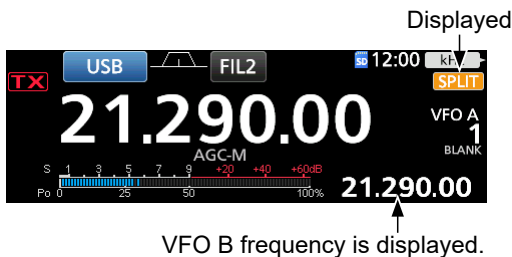

3. While holding down **[XFC]**, set the operating frequency offset between transmit and receive. (Example: 5.00 kHz)

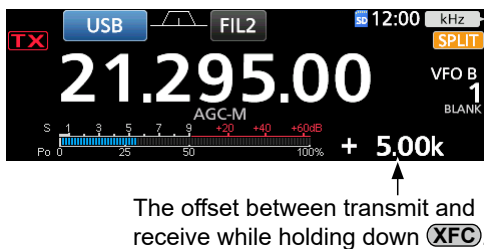

◇ Using the receive and transmit frequencies set to VFO A and VFO B

1. Set VFO A's receive frequency and operating mode. (Example: 21.29000 MHz in the USB mode)



2. Push **[A/B]** to select VFO B, and then set the receive frequency and the operating mode. (Example: 21.29500 MHz in the USB mode)



3. Push **[SPLIT]**.
 - Pushing **[SPLIT]** turns the Split function ON or OFF.

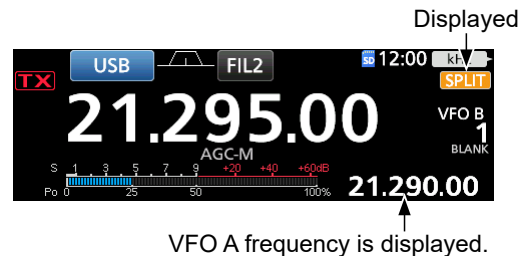

4. Push **[A/B]** to return to VFO A.
 - ① The Split frequency operation is ready.

Split Lock function

To prevent accidentally changing the receive frequency by releasing (XFC) while rotating (MAIN DIAL), use the Split Lock function. Using both this function and the Dial Lock function enables you to change only the transmit frequency.

1. Turn ON the Split Lock function.
[MENU] » **SET > Function > SPLIT > SPLIT LOCK**
2. Turn ON the Split function.
3. Hold down (SPEECH) for 1 second to turn ON the Dial Lock function.
4. While holding down (XFC), set the transmit frequency.



Displayed when the Dial Lock function is ON.

IP Plus function

The IP Plus function improves the Intermodulation Distortion (IMD) quality by exerting the direct sampling system performance.

This function optimizes the Analog/Digital Converter (ADC) against the distortion when you receive a strong input signal. It also improves the Third-order Intercept Point (IP3) while minimizing the reduction of the receive sensitivity.

1. Push **[FUNCTION]**.
 • Opens the FUNCTION screen.
2. Touch **[IP+]**.
 ① Touch **[IP+]** to turn the IP Plus function ON or OFF.
 ① Select ON to prioritize the IP quality, and select OFF to prioritize the receive sensitivity.



3. To close the FUNCTION screen, push **[EXIT]**.

Monitor function

SSB, CW, RTTY, AM, and FM modes

The Monitor function enables you to monitor your transmit audio. Use this function to check the voice characteristics while adjusting transmit audio parameters.

① You can hear the CW sidetone regardless of the Monitor function setting.

1. Select the operating mode that you want to monitor. (Example: SSB)
2. Push **[FUNCTION]**.
 • Opens the FUNCTION screen.
3. Touch **[MONI]** to turn ON the Monitor function.



① Touching **[MONI]** turns the Monitor function ON or OFF.

4. If you want to adjust the monitor audio output, touch **[MONI]** for 1 second.



5. Rotate (MULTI) to adjust MONITOR to the clearest audio output between 0% and 100%, while speaking at your normal voice level.



6. To close the Multi-function menu, push (MULTI).

NOTE: When using the VOX function, turn OFF the Monitor function. Otherwise, the transmitted audio will echo.

Operating CW

◇ Setting the CW pitch control

You can set the received CW audio pitch and the CW side tone to suit your preference, without changing the operating frequency.

1. Select the CW mode.
2. Push **[MULTI]** to open the Multi-function menu.
3. Touch [CW PITCH].

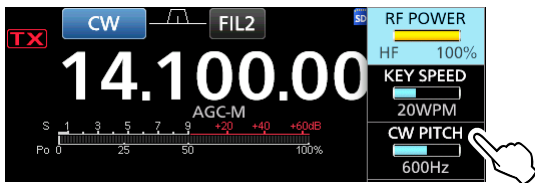

4. Rotate **[MULTI]** to set the CW pitch to between 300 and 900 Hz (in 5 Hz steps).
5. To close the Multi-function menu, push **[MULTI]**.

TIP: To graphically display the CW pitch, open the FILTER screen by touching the IF Filter indicator for 1 second.

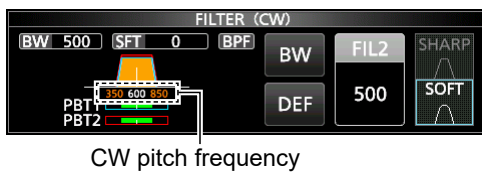

When the selected IF filter is:

- Below 500 Hz, the CW pitch frequency is graphically changed in 5 Hz steps.
- Above 600 Hz, the CW pitch frequency is graphically changed in 25 Hz steps.

◇ Setting the key speed

You can set the keying speed of the internal electronic keyer.

1. Select the CW mode.
2. Push **[MULTI]** to open the Multi-function menu.
3. Touch [KEY SPEED].

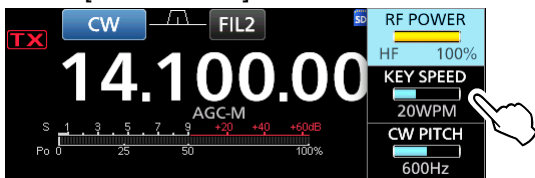

4. Rotate **[MULTI]** to set the key speed to between 6 and 48 Words Per Minute (WPM).
5. To close the Multi-function menu, push **[MULTI]**.

◇ Using the Break-in function

Use the Break-in function in the CW mode to automatically switch between transmit and receive when keying. The IC-7300MK2 can operate in the Semi Break-in and Full Break-in modes.

TIP: “Key Type” is set to “Paddle” by default. You can select the keyer type in the following item.

[MENU] » **SET > CW-KEY Set > Key Type**

Semi Break-in operation

In the Semi Break-in mode, the transceiver transmits when keying, and then automatically returns to receive after a preset time after you stop keying.

1. Select the CW mode.
2. Push **[VOX/BK-IN]** several times to select “BKIN.”

[VOX/BK-IN]

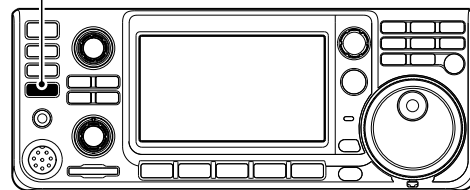

- The “BKIN” icon is displayed.
- ① Pushing **[VOX/BK-IN]** selects “BKIN (Semi Break-in),” “F-BKIN (Full Break-in),” or OFF (no indication).
 3. To adjust the Break-in delay time, hold down **[VOX/BK-IN]** for 1 second.
 - Opens the BKIN menu.
 4. Rotate **[MULTI]** to set the Break-in delay time to where the transceiver returns to receiving after the desired delay time after you stop keying.

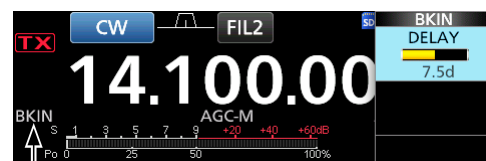

The selected mode (Semi Break-in) is displayed.

- ① When using a paddle, push **[MULTI]** to open the Multi-function menu, and then adjust the KEY SPEED while operating the paddle.
5. To close the BKIN menu, push **[MULTI]**.

Operating CW

◆ Full Break-in operation

In the Full Break-in mode, the transceiver automatically transmits while keying down, and then immediately returns to receiving after keying up.

1. Select the CW mode.
2. Push **[VOX/BK-IN]** several times to select "F-BKIN."



The selected mode (Full Break-in) is displayed.

- The "F-BKIN" icon is displayed.
 - ① Pushing **[VOX/BK-IN]** selects "BKIN (Semi Break-in)," "F-BKIN (Full Break-in)," or OFF (no indication).
3. Use a straight key or paddle.
 - ① In the Full Break-in mode, the transceiver automatically returns to receive immediately after you key up. The transceiver receives while keying up.

◆ Monitoring the CW side tone

When the transceiver is in standby and the Break-in function is OFF, you can listen to the CW side tone without actually transmitting.

① Information

- This enables you to match your transmit frequency exactly to another station's by matching the audio tone.
- You can also use the CW side tone (make sure the Break-in function is OFF) to practice CW sending.
- You can adjust the CW side tone level in the following item.

[MENU] » **SET > CW-KEY Set > Side Tone Level**

◆ CW Auto Tuning function

You can tune in a CW signal you are receiving using the Auto Tuning function. You can automatically tune the signal in the IF passband width in the CW mode.

1. Select the CW mode.
2. Push **[AUTO TUNE]** to start the Auto Tuning.
 - ① While using the RIT function, the RIT frequency is automatically tuned by this function.



Displayed while tuning.

NOTE: When receiving a weak signal or a signal with interference, the Auto Tuning function may tune the receiver to an undesired signal, or may not start to tune. In such a case, a warning beep sounds.

◆ Audio Peak Filter (APF) operation

The APF enables you to set excellent selectivity in the CW mode. You can set the selectivity to between the 3 APF passband widths.

1. Select the CW mode.
2. Push **[FUNCTION]**.
 - Opens the FUNCTION screen.
3. Touching **[2]** at the bottom of the screen to select the FUNCTION screen 2.
4. Touch **[APF]** to turn ON the Audio Peak Filter.

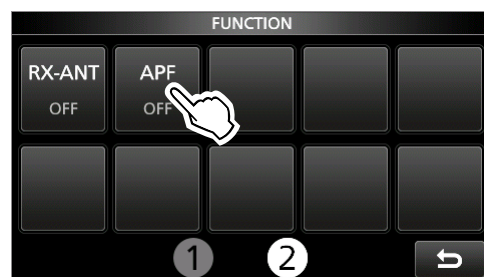

5. Hold down **[APF]** for 1 second.
 - Opens the APF menu.



6. Touch to select the item, and then set the audio filter position, passband width, and the audio level.



7. To close the APF menu, push **[MULTI]**.

Operating CW

◇ Audio Peak Filter (APF) operation

POSITION

Shifts the peak frequency of the APF. This function enables you to avoid interference from adjacent frequencies.

WIDTH (Default: WIDE)

Selects the APF passband width.

- When “TYPE” is set to “SOFT,” select WIDE, MID, or NAR.
- When “TYPE” is set to “SHARP,” select 320 Hz, 160 Hz, or 80 Hz.

TYPE (Default: SOFT)

Selects the audio filter type (soft sound or sharp sound).

AF LEVEL (Default: 0 dB)

Sets the audio level between 0 dB and +6 dB in 1 dB steps.

◇ About the Electronic Keyer function

You can set the Memory Keyer function settings, paddle polarity settings, and so on of the Electronic Keyer.

1. Select the CW mode.
2. Push **MENU**.
 - Opens the MENU screen.
3. Touch [KEYER/DECODE].



- Opens the KEYER/CW DECODE dialog.
- ① You can change the action of [KEYER/DECODE] on the MENU SET screen. See the Advanced manual for details.

4. Touch [KEYER].

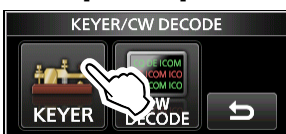

- Opens the KEYER screen.

5. Touch [EDIT/SET].



- Opens the EDIT/SET screen.

6. Select the desired item to set.

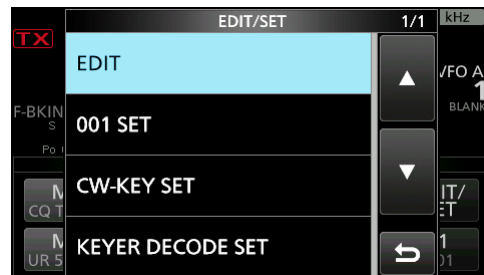

- **EDIT:**
Opens the KEYER MEMORY edit menu, and you can edit the Keyer memories M1 to M8.
- **001 SET:**
Opens the KEYER 001 Contest Number menu, and you can set the following items.
 - Number Style
 - Count Up Trigger
 - Present Number
- **CW-KEY SET:**
Opens the CW-KEY SET menu, and you can set the following items.
 - Side Tone Level
 - Side Tone Level Limit
 - Keyer Repeat Time
 - Dot/Dash Ratio
 - Rise Time
 - Paddle Polarity
 - Key Type
 - MIC Up/Down Keyer
 ① You can also set the same items in the Set mode.

MENU » SET > CW-KEY Set

- **KEYER DECODE SET:**
Opens the KEYER DECODE SET menu, and you can set the following items.
 - Decode Display
 - Japanese Morse Decode*
 * Displayed only when the “System Language” item is set to “Japanese.”

MENU » SET > Display > System Language

7. To close the KEYER screen, push **EXIT** several times.

Spectrum scope screen

The spectrum scope enables you to display the activity in the selected band and the relative strengths of various signals in that band.

The transceiver has three spectrum scope modes, the Center mode, the Fixed mode, and the Scroll mode. You can also turn the Waterfall display ON or OFF. In addition, you can select the Mini scope to display the scope on the screen in a smaller size.

• Center mode screen

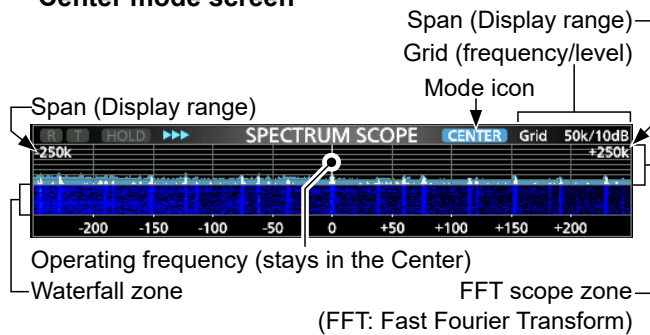

• Fixed mode screen

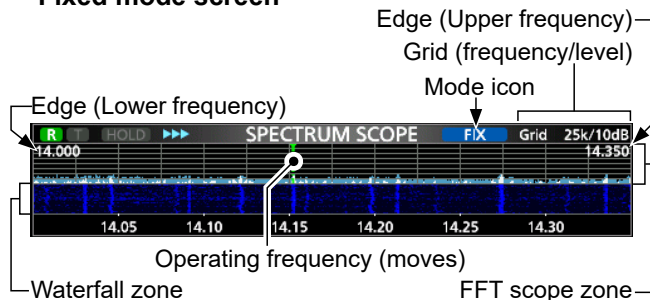

• Scroll mode screen

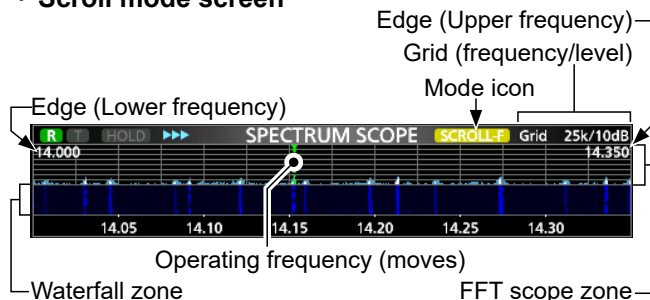

* When in the SCROLL-C mode, **SCROLL-C** is displayed.

◇ Using the Spectrum Scope

Display the SPECTRUM SCOPE screen.

MENU » **SCOPE**

MENU 1: Center/Scroll-C mode

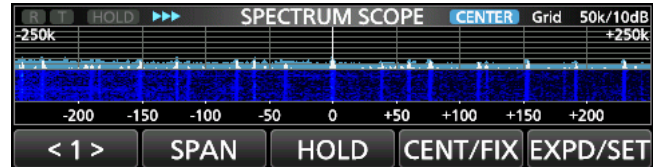

MENU 1: Fix/Scroll-F mode



MENU 2: Center/Fix/Scroll-C/Scroll-F mode





Key	Action	
< 1 > / < 2 >	Selects the Function menus.	
SPAN	Touch	In the Center or Scroll-C mode, selects the scope span. • Spans: ± 2.5, 5.0, 10, 25, 50, 100, 250, and 500 kHz
	Touch for 1 second	Resets to the ±2.5 kHz span.
EDGE	In the Fixed mode and the Scroll-F mode, selects the Edge frequencies. ① You can set the upper and lower Edge frequencies in "Fixed Edges" on the SCOPE SET screen by touching [EXPD/SET] for 1 second.	
HOLD	Touch	Turns the Hold function ON or OFF. • [HOLD] and the Marker are displayed. Freezes the current spectrum.
	Touch for 1 second	Clears the Peak Hold level.
CENT/FIX	Touch	Selects the Center or Fixed mode.
	Touch for 1 second	Selects the Scroll mode.
EXPD/SET	Touch	Selects the Expanded or Normal screen.
	Touch for 1 second	Displays the SCOPE SET screen. ① See the Advanced manual for details.
REF	Opens the "REF Level" window. ① Rotate [MAIN DIAL] to adjust the Reference level. ① Touch again to close the window.	
SPEED	Selects the sweep speed. • "▶▶▶" (FAST), "▶▶" (MID), or "▶" (SLOW).	
MARKER	Selects various Markers.	

Spectrum scope screen

◇ Center mode

Displays signals around the operating frequency within the selected span. The operating frequency is always displayed in the center of the screen.

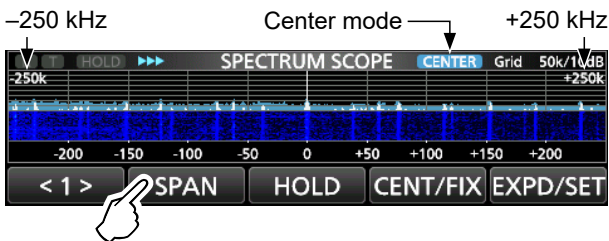

1. Open the SPECTRUM SCOPE screen.
 » 
2. Touch [CENT/FIX].
 ⓘ Touch [CENT/FIX] to toggle between the Center and Fixed modes.
3. Touch [SPAN] several times to select the scope span.
 - ±2.5, 5.0, 10, 25, 50, 100, 250, and 500 kHz
 - ⓘ Touch [SPAN] for 1 second to select the ±2.5 kHz span.



◇ Fixed mode

Displays signals within a specified frequency range. The selected frequency band activity can easily be observed in this mode.

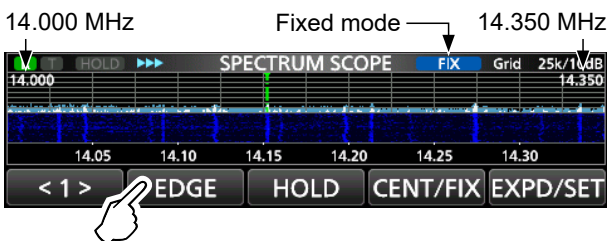

Four Fixed Edge bands can be set for each amateur frequency band covered by the transceiver in the SCOPE SET screen.

1. Display the SPECTRUM SCOPE screen.
 » 
2. Touch [CENT/FIX].
 ⓘ Touch [CENT/FIX] to toggle between the Center and Fixed modes.
3. Touch [EDGE] several times to select the Edge frequency.
 - ⓘ When the operating frequency moves outside the upper or lower edge frequency, ">>" or "<<" is displayed in the upper side corners of the SPECTRUM SCOPE screen.
 - >>: The frequency is outside the higher edge.
 - <<: The frequency is outside the lower edge.
 When the frequency goes further away, "Scope Out of Range" is displayed.
 - ⓘ When scrolling out of, or back into the selected Fixed Edges, a beep sounds.



◇ Scroll mode

Displays signals within a selected span. When the operating frequency moves outside of the screen, the displayed frequency range is automatically scrolled.

1. Open the SPECTRUM SCOPE screen.
 » 
2. Touch [CENT/FIX] for 1 second to select the Scroll mode.
 - When changing the Center mode to the Scroll mode, "SCROLL-C" is displayed. You can change the scope span by touching [SPAN].
 - When changing the Fixed mode to the Scroll mode, "SCROLL-F" is displayed. You can change the Edge frequencies by touching [EDGE].
3. Touch [CENT/FIX] to return to the previous mode.
 - When returning to the Center mode, the scope span does not return to the previous setting.
 - When returning to the Fixed mode, the Edge frequencies return to the last selected "Fixed Edges." If the operating frequency is above the upper Edge frequency, or below the lower Edge frequency, ">>" or "<<" is displayed in the upper side corners of the SPECTRUM SCOPE screen.

◇ Marker

The Marker displays the operating frequency in the SPECTRUM SCOPE screen.

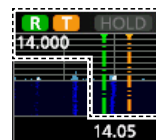

- R:** The RX marker
 - Marks the receive frequency.
- T:** The TX marker
 - Marks the transmit frequency.

• About RX Marker

In the Fixed or Scroll mode, the RX Marker displays the operating frequency within a specified frequency range. So, the transceiver always displays the RX marker on the scope screen.

In the Center mode, the operating frequency stays in the center of the screen. Thus, the transceiver does not display the RX Marker.

- ⓘ When the Hold function is ON, the RX Marker is displayed to indicate the operating frequency's location.

Spectrum scope screen

◇ Touch screen operation

When you touch the FFT scope zone or the waterfall zone in the SPECTRUM SCOPE screen, the area will be zoomed in. Then, you touch the signal in the zoomed area, and you can directly tune your frequency to the signal in the SPECTRUM SCOPE screen.
 ⓘ Holding down **XFC** changes the transmit frequency.

1. Display the SPECTRUM SCOPE screen.
MENU » **SCOPE**
2. Touch the Scope screen.
 - The area around the touched point is zoomed in.

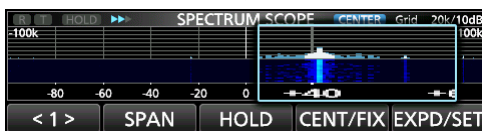
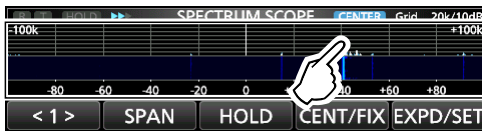

3. Touch the signal in the zoomed area.

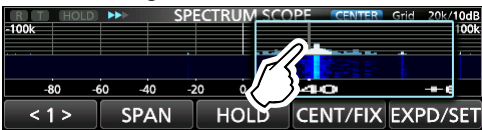

ⓘ Information

- In the Center mode, the operating frequency changes to the touched point, and the point moves to the screen center.
- In the Fixed mode, the operating frequency and marker change to the touched point.
- Touch out of the zoomed area to close the zoomed window.

◇ Mini scope screen

The Mini scope screen can be simultaneously displayed with another function display, such as the CW DECODE screen, RTTY DECODE screen, AUDIO SCOPE screen, or FUNCTION screen.

- Push **M.SCOPE** to turn the Mini scope screen ON or OFF.
 ⓘ Hold down **M.SCOPE** for 1 second to display the SPECTRUM SCOPE screen.

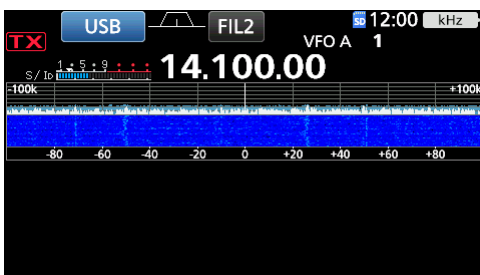

Audio scope screen

This audio scope enables you to display the received signal's frequency component on the FFT scope, and its waveform components on the Oscilloscope. The FFT scope also has a waterfall.

• AUDIO SCOPE screen

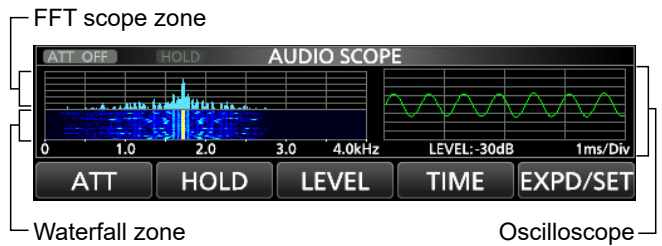

◇ Using the Audio Scope

Display the AUDIO SCOPE screen.

MENU » **AUDIO**

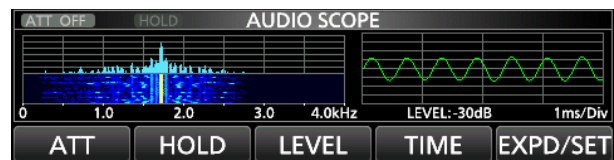

Key	Action	
ATT	Touch	Selects the attenuator for the FFT scope. • 0 (OFF), 10, 20, or 30 dB
	Touch for 1 second	Turns OFF the attenuator. (0 dB)
HOLD	Turns the Hold function ON or OFF. • HOLD is displayed and freezes the current audio spectrum.	
LEVEL	Selects the Oscilloscope level. • 0, -10, -20, or -30 dB	
TIME	Selects the Oscilloscope sweep time. • 1, 3, 10, 30, 100, or 300 ms/Div	
EXPD/SET	Touch	Selects the Expanded or Normal screen.
	Touch for 1 second	Displays the AUDIO SCOPE SET screen. ⓘ See the Advanced manual for details.

The SD cards, SDHC cards, and SDXC cards are user supplied.

TIP: Icom recommends that you save the transceiver's factory default data for backup.

About the SD cards

You can use an SD card of up to 2 GB, an SDHC of up to 32 GB, or an SDXC of up to 256 GB. Icom has checked the compatibility of the following cards.

(As of November 2025)

Brand	Type	Capacity
SanDisk®	SD	2 GB
	SDHC	4/8/16/32 GB
	SDXC	64/128/256 GB

- ① The above list does not guarantee the card's performance.
- ① Throughout the rest of this document, the SD cards, SDHC cards, and SDXC cards are simply called the SD card or the card.

NOTE:

- Before using the SD card, thoroughly read their instructions.
- If any of the following occur, the card's data may be corrupted or deleted.
 - You remove the card from the transceiver while it is still accessing the card.
 - A power failure occurs, or the power cable is disconnected, while accessing the card.
 - You drop, impact, or vibrate the card.
- Do not touch the contacts of the card.
- The transceiver may take a longer time to recognize a high capacity card.
- The card has a certain lifetime, so data reading or writing may not be possible after using it for a long period of time. In that case, use a new one. We recommend that you make a backup of the data onto another device.
- Icom will not be responsible for any damage caused by data corruption on a card.

Saving data

You can save the following data onto the card.

- The transceiver's settings
- Communication/receive log and contents
- Voice audio for the Voice TX function
- RTTY decode log
- Captured screens

Inserting

Insert the SD card as shown below.

- ① Insert the SD card into the slot until it locks in place, and makes a 'click' sound.
- ① Be sure to check the card orientation before inserting.

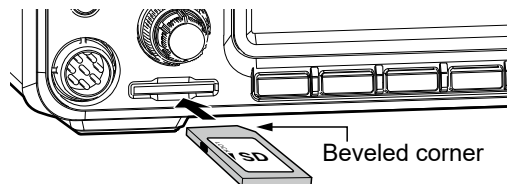

NOTE: Before using an SD card for the first time, format it in the transceiver.

- Formatting a card erases all its data. Before formatting any used card, back up its data onto another device.
- After inserting or formatting, a special folder on the card that you need for operations like updating the firmware is created on the card.

IMPORTANT: Even if you have formatted an SD card, some data may remain in the card. When you dispose of the card, be sure to physically destroy it to avoid unauthorized access to any data that remains.

Formatting

Before using an SD card, format it to be used with the transceiver by doing the following steps.

1. Open the SD CARD screen.

MENU » **SET > SD CARD**

2. Touch "Format."

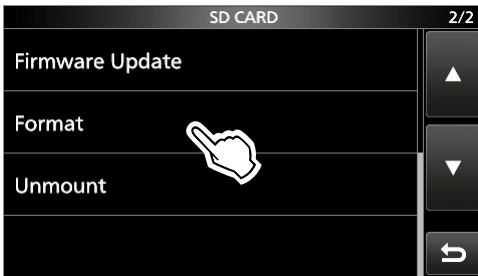

3. Touch [YES] to start formatting.

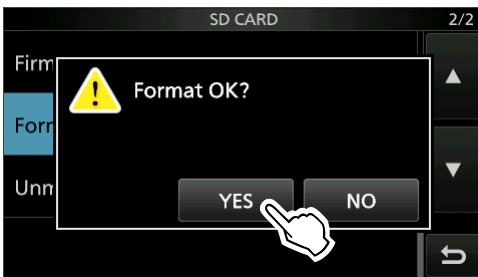

- After formatting, returns to the SD CARD screen.
- ① To cancel formatting, touch [NO].

4. To close the SD CARD screen, push **EXIT** several times.

Unmounting

Before you remove a card when the transceiver is ON, be sure to electrically unmount it, as shown below. Otherwise, the data may be corrupted or deleted.

1. Open the SD CARD screen.

MENU » **SET > SD CARD**

2. Touch "Unmount."

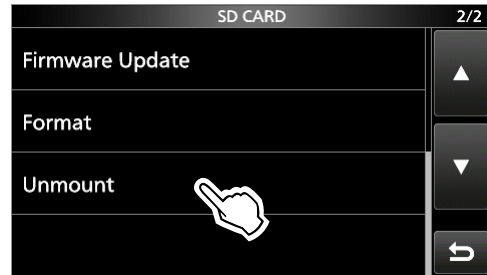

3. Touch [YES] to unmount.

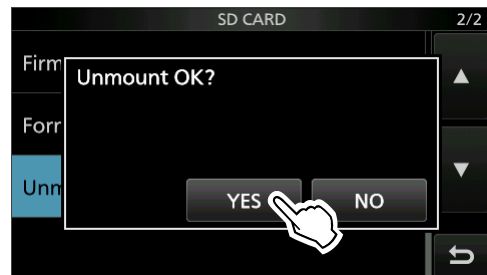

- After unmounting, returns to the SD CARD screen.
- ① To cancel unmounting, touch [NO].

4. Remove the card from the transceiver.

- Push in the card until a 'click' sounds to unlock the card, and then pull it out.

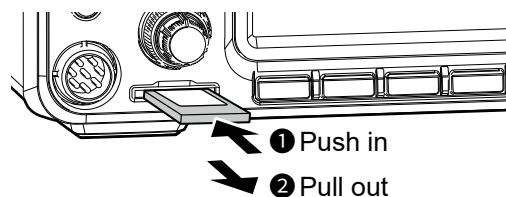

5. To close the SD CARD screen, push **EXIT** several times.

When the transceiver is OFF

You can remove the card starting from step 4 of the steps described above.

About the internal antenna tuner

The internal automatic antenna tuner automatically matches the transceiver to the antenna within the range of 16.7 ~ 150 Ω (SWR of less than 3:1). After the tuner matches an antenna, the latching relay combinations are memorized as a preset point for each frequency. Therefore, when you change the frequency, the latching relay combinations are automatically preset to the memorized point.

① When you install a new antenna, or you want to change the antenna settings, you can clear all of the internal antenna tuner preset points with the “<<Preset Memory Clear>>” item on the TUNER set screen. (p. 52)

MENU » SET > Function > Tuner >
 <<Preset Memory Clear>>

NOTE:

- If the SWR is higher than about 1.5:1, hold down **TUNER** for 1 second to start manual tuning.
- When the transceiver receives a strong physical shock, the internal latching relays may be returned to an unlatched condition. In that case, push **TUNER** to turn OFF the tuner, then turn it ON again to reset all latching relays.

◇ Using the Internal antenna tuner

1. Push **TUNER** to turn ON the internal antenna tuner.
 - **TUNE** is displayed.

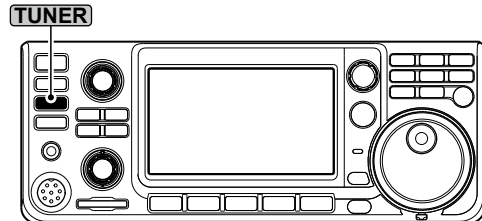

2. Match the antenna.
 - ① To match the antenna, see “Manual tuning” or “PTT Tuner start” below.

◇ Manual tuning

You can manually match the antenna before transmitting for the first time.

1. Hold down **TUNER** for 1 second to start manual tuning.
 - The tuner reduces the SWR to less than 1.5:1 after 2 ~ 3 seconds of tuning.
 - ① While tuning, **TUNE** blinks red.
2. After matching, **TUNE** is displayed.
 - ① If the tuner cannot tune, the tuning circuit is automatically bypassed and **TUNE** (blinks red) goes out.

◇ PTT Tuner start

The tuner is always activated when [PTT] is pushed after the frequency is changed (more than 1% from the last-tuned frequency). This function matches the antenna for the first transmission on a new frequency.

① You can turn OFF this function in the “PTT Start” item on the TUNER screen. (p. 52)

MENU » SET > Function > Tuner > **PTT Start**

TIP: If the tuner cannot match the antenna

Even if the tuner cannot match the antenna on the first attempt, it may succeed by repeating the tuning several times.

About the external antenna tuner

The optional AH-730 ANTENNA TUNER matches the IC-7300MK2 to a long wire antenna more than 7 m/23 ft long (1.8 MHz to 54 MHz).

The optional AH-740 AUTOMATIC TUNING ANTENNA covers a 2.5 to 30 MHz range with a supplied whip antenna.

⚠ DANGER HIGH VOLTAGE! NEVER touch the antenna element while tuning or transmitting. Always install it in a secure place.

NEVER operate the AH-730 or AH-740 without an antenna connected. The tuner and transceiver will be damaged.

◇ Using the AH-730 or AH-740

1. Turn ON the transceiver.
2. Push **TUNER** to start tuning.
 - The tuner reduces the SWR to less than 2:1 after 2 ~ 3 seconds.
 - ① While tuning, a side tone is heard and **TUNE** blinks red.
 - ① If the tuner cannot reduce the SWR to less than 2:1 after 15 seconds of tuning, **TUNE** (blinks red) goes out.
3. After matching, **TUNE** is displayed, and the AH-730 or AH-740 is turned ON.
 - ① When the long wire antenna cannot be matched, **TUNE** goes out. In that case, the AH-730 is bypassed, and the wire is directly connected.
4. To start manual tuning while **TUNE** is displayed, hold down **TUNER** for 1 second.
5. To turn OFF (bypassed) the AH-730 or AH-740, push **TUNER**.

NOTE: When the wire antenna cannot be tuned, confirm the wire length and connection. Note that the AH-730 cannot tune a wire that is a $\frac{1}{2}\lambda$ long or on a multiple of that frequency.

◇ Using the IC-PW2

When you use the internal antenna tuner of the IC-PW2, be sure to turn OFF the IC-7300MK2's internal antenna tuner before connecting it.

To tune at the desired operating frequency, do manual tuning on the IC-PW2.

- To tune to the selected operating frequency, the IC-PW2's linked manual tuning operation is required. By holding down **TUNER** on the IC-PW2 for 1 second, the transceiver automatically starts transmitting to perform the linked manual tuning.
- ① During the linked manual tuning, the meter readout of the transceiver can be changed.
- ① To cancel the linked manual tuning, push **TUNER** on the IC-7300MK2. When the linked manual tuning is canceled, **TUNE** (blinks red) goes out.
- ① See the IC-PW2 instruction manual for details.

◇ Using an external antenna tuner

When you use a non-Icom external antenna tuner, be sure to turn OFF the internal antenna tuner before connecting it.

Otherwise, the tuning may fail because both antenna tuners (internal and external) will simultaneously start tuning.

See the antenna tuner's instruction manual for details.

NOTE: Be sure not to connect the antenna tuner without an antenna connected. This could damage the transceiver or external antenna tuner.

TIP: If the SWR is not reduced to 2:1 after retuning, see "If the tuner cannot match the antenna" for details. (p. 46)

Emergency mode (Tuner)

The Emergency mode (Tuner) enables you to use the internal antenna tuner in an emergency situation, but limits the maximum output power to 50 W. In an emergency situation, where the only antenna you have has a high SWR, you can use the antenna tuner even if the SWR is more than 3:1.

1. Open the EMERGENCY screen.

MENU » **SET** > Others > **Emergency**

2. Touch "Tuner."



3. Touch [OK].

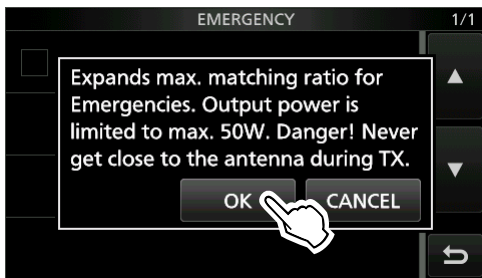

4. Touch "<<Restart to SET>>" to restart the transceiver.



- The transceiver enters the Emergency mode (Tuner).

- E**: Displayed in orange when the internal antenna tuner is OFF.
- E-TUN**: Blinks red while tuning.
- E-TUN**: Displayed in orange when the internal antenna tuner is ON.

① While in the Emergency mode (Tuner), you cannot turn the internal antenna tuner ON or OFF by pushing **TUNER**.

TIP: To exit the Emergency mode:

Touch "Tuner" again on the EMERGENCY screen to clear "✓" from the Tuner check box, and then, touch "<<Restart to SET>>" to restart the transceiver.

Set mode description

You can use the Set mode to set infrequently changed values or function settings.

TIP: The Set mode is constructed in a tree structure. You can go to the next tree level, or go back a level, depending on the selected item.

1. Push **MENU**.

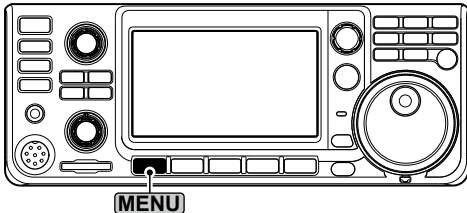

2. Touch **[SET]**.



3. Touch the category that you want to select.

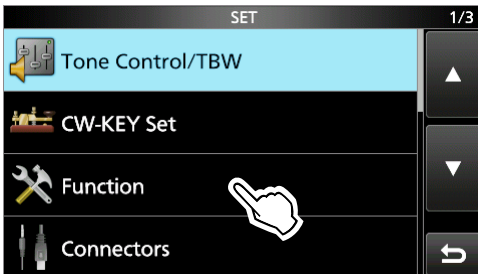

4. Touch **[▲]** or **[▼]** to scroll through the items.

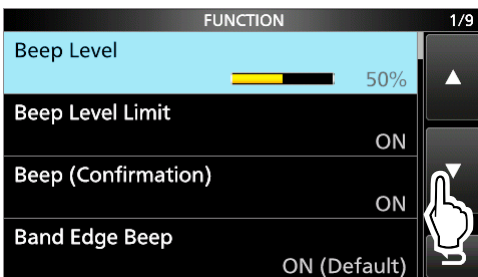

- ① You can also rotate **ⓂMULTI** to scroll through the items.

5. Touch the item to open its setting screen or its next tree level.

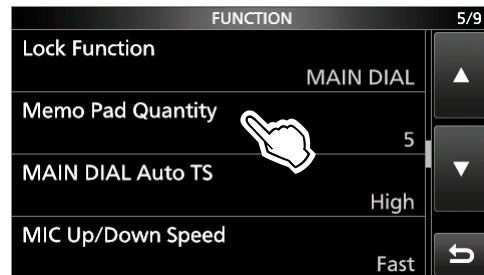

- ① Repeat steps 4 and 5 to open the desired item's setting screen.

- ① To go back a tree level, push **EXIT**.

6. Touch to select or to set the option.

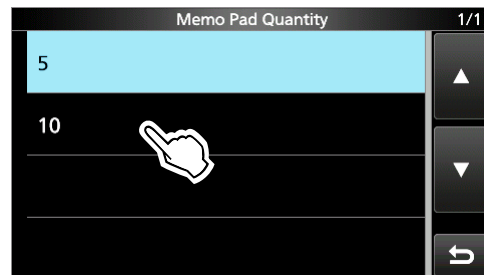

- The selected option is saved, and returns to the previous screen.

7. To close the SET screen, push **EXIT** several times.

TIP: Resetting to the default setting

1. Push **QUICK** to display the QUICK MENU screen.
2. Touch "Default" to reset to the default setting.

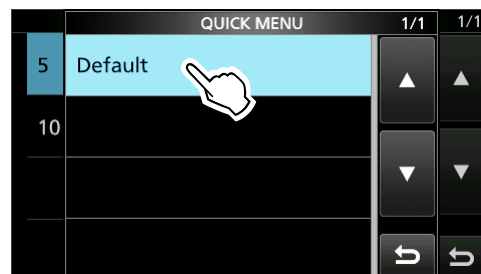

- ① To close the QUICK MENU screen, push **EXIT**.

NOTE: The default settings shown below are for the USA transceiver version. The default settings may differ, depending on your transceiver version.

Tone Control/TBW

MENU » SET > Tone Control/TBW > **RX**

SSB, AM, FM, CW, RTTY

RX HPF/LPF (Default: - - - - -)

Sets the cut-off frequencies for the receive audio high-pass filter and low-pass filter, in 100 Hz steps.

- ① If this item is set, the “RX Bass” and “RX Treble” items are automatically set to “0.”
- ① In the Data mode, the Tone Control settings are automatically disabled.

SSB, AM, FM

RX Bass (Default: 0)

RX Treble (Default: 0)

Sets the bass or treble level of the received audio.

- ① In the Data mode, the Tone Control settings are automatically disabled.

MENU » SET > Tone Control/TBW > **TX**

SSB, AM, FM

TX Bass (Default: 0)

TX Treble (Default: 0)

Sets the bass or treble level of the transmit audio.

SSB

TBW (WIDE) (Default: 100 – 2900)

TBW (MID) (Default: 300 – 2700)

TBW (NAR) (Default: 500 – 2500)

Sets the transmission passband width to wide, mid, or narrow, by changing the lower and upper cut-off frequencies.

SSB-D

TBW (Default: 300 – 2700)

Sets the transmission passband width by changing the lower and upper cut-off frequencies.

CW-KEY Set

① You can also set the same items in the CW-KEY SET menu on the KEYSER screen. (p. 40)

MENU » SET > **CW-KEY Set**

Side Tone Level (Default: 50%)

Sets the CW side tone output level.

- Set to between 0 ~ 100%.

Side Tone Level Limit (Default: ON)

Turns the CW side tone level limit ON or OFF. This function disables the CW side tone when you increase AF GAIN above the side tone level.

Keyer Repeat Time (Default: 2sec)

Sets the time between Memory keyer transmissions.

- Set to between 1 ~ 60 seconds.
- ① After transmitting the Memory keyer contents, the transmission is repeated after the set time period.
- ①  is displayed, even between transmissions.

Dot/Dash Ratio (Default: 1:1:3.0)

Sets the dot/dash ratio.

- Set to between 1:1:2.8 ~ 1:1:4.5 in 0.1 steps.

Keying weight example: Morse code “K”

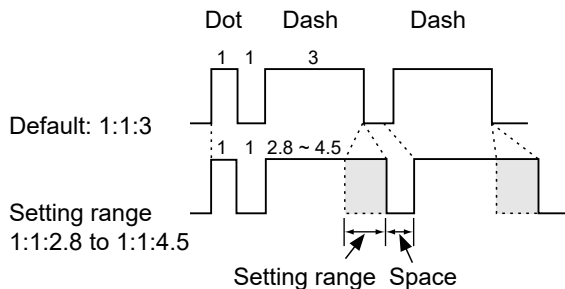

Rise Time (Default: 4ms)

Sets the rise time of the transmitted CW envelope.

- Set to 2, 4, 6, or 8 milliseconds.

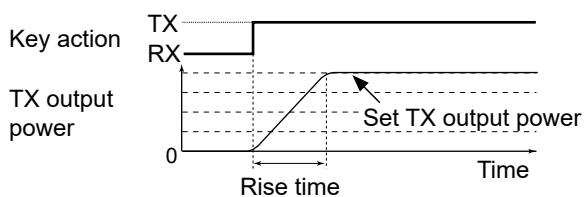

CW-KEY Set

Paddle Polarity (Default: Normal)

Sets the paddle dot-dash polarity to Normal or Reverse.

- Normal: Right = dash, Left = dot
- Reverse: Right = dot, Left = dash

Key Type (Default: Paddle)

Sets the key type for the [KEY] jack.

- Set to Straight, Bug, or Paddle.

① When using an external Elec-keyer, select "Straight."

MIC Up/Down Keyer (Default: OFF)

Selects whether or not the keys on the microphone can be used as a CW key.

- OFF: Cannot use the microphone keys as a CW key.
- ON: Can use the [UP]/[DN] keys as a CW key.

① The microphone keys do not work as a "squeeze key."

① When "ON" is selected, you cannot use the function that is assigned to each key.

Function

MENU » **SET > Function**

Beep Level (Default: 50%)

Sets the beep output level.

① If "Beep (Confirmation)" is set to "OFF," no beep sounds.

Beep Level Limit (Default: ON)

Selects whether or not to limit the volume up to a specified level.

- OFF: Does not limit the volume level.
- ON: Limits the volume level.

Beep (Confirmation) (Default: ON)

Turns the Confirmation beep ON or OFF.

- OFF: Turns OFF the function for silent operation.
- ON: A beep sounds when a switch is pushed or the touch panel is touched.

① If "Beep Level" is set to "0%," no beep sounds.

Band Edge Beep (Default: ON (Default))

Selects an option for the Band Edge Beep function.

- OFF: Turns OFF the function.
- ON (Default): A beep sounds when you tune out of, or back into the default amateur band's frequency range.
- ON (User): A beep sounds when you tune out of, or back into a user programmed amateur band's frequency range.
- ON (User) & TX Limit: A beep sounds when you tune out of, or back into a user programmed amateur band's frequency range. Transmitting is inhibited outside of the range.

① If "Beep Level" is set to "0%," no beep sounds.

RF/SQL Control (Default: RF+SQL)

Set the AF RF/SQL (outer) control operation.

① See the Advanced manual for details.

Function

Cancel CI-V Remote Set Levels (Default: All Volume Levels)

While remotely controlling the transceiver, sent CI-V commands override some of the control dials' setting values.

Select whether or not to overwrite all control dial setting values (such as the AF Volume dial with a mark on it) by their position if one of them on the transceiver is rotated.

- All Volume Levels:
All dials' setting values are overwritten by their position, even if one of them is rotated.
- Operated Volume Level:
Only the rotated dial's setting value is overwritten by its position.

MF Band ATT (Default: ON)

Turns the MF Band Attenuator function ON or OFF. This function adds approximately 16 dB of attenuation to prevent a desired signal from becoming distorted when very strong MF band signals are received.

This function is usable when the frequency is set to between 0.03000 and 1.59999 MHz, for only receiving.

- ① When you receive a weak signal on the MF band, select "OFF."
- ① The 16 dB of the MF band attenuation is added to any other attenuation value that you have set.

MENU » SET > Function > TX Delay

HF	(Default: OFF)
50M	(Default: OFF)
70M*	(Default: OFF)

Sets the TX delay time on each band.

- ① If an external equipment's rise time is slower than that of the IC-7300MK2, a reflected wave is produced, and it may damage the IC-7300MK2 or the external device. To prevent this, set the appropriate delay time so that no reflected wave or timing damage occurs.
- ① Select "OFF" for no delay.

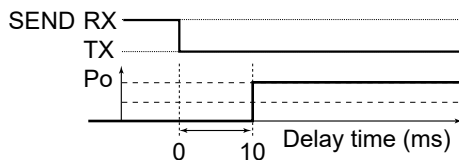

* This item may not be displayed, depending on the transceiver version.

MENU » SET > Function

Time-Out Timer (CI-V) (Default: OFF)

Sets the Time-out Timer for CI-V operation to OFF, 3, 5, 10, 20, or 30 minutes to prevent an accidental prolonged transmission.

This setting is valid only for transmissions initiated by a CI-V command or by pushing **TRANSMIT**.

- ① Select "OFF" for no time limit.

MENU » SET > Function > SPLIT

Quick SPLIT (Default: ON)

Turns the Quick Split function ON or OFF. This function automatically turns ON the SPLIT function, and set the frequency and mode that is not displayed (VFO A or AFO B), according to the SPLIT Offset setting.

- OFF: Turns OFF the function.
- ON: Turns ON the function.

FM SPLIT Offset (HF)	(Default: -0.100 MHz)
FM SPLIT Offset (50M)	(Default: -0.500 MHz)

In the FM mode, sets the SPLIT offset between -9.999 and +9.999 MHz.

The SPLIT offset is the difference between the receive and transmit frequencies for the Quick SPLIT function.

SPLIT LOCK (Default: OFF)

Turns the Split Lock function ON or OFF. The SPLIT LOCK function enables you to adjust the transmit frequency while holding down **XFC**, even while the Dial Lock function is activated. To prevent accidentally changing the receive frequency by rotating **MAIN DIAL**, use both the SPLIT LOCK (p. 37) and Dial Lock functions (p. 27).

MENU » SET > Function > Tuner

[Tuner] Switch (Default: Auto)

Selects whether or not to save the internal antenna tuner's status after pushing **TUNER** on each band.

- Manual: The internal antenna tuner's status is saved on all bands.
- Auto: The internal antenna tuner's status is saved on each band.

PTT Start (Default: OFF)

Turns the PTT Start Tuning function ON or OFF. This function starts tuning when [PTT] is pushed, if the operating frequency is shifted 1% or more while the antenna tuner is ON.

<<Preset Memory Clear>>

Clears all of the internal antenna tuner's entered memory frequencies.

Function

MENU » SET > Function**RTTY Mark Frequency** (Default: 2125)

Selects the RTTY mark frequency.

① When the internal RTTY decoder is used, 2125 Hz is automatically selected.

RTTY Shift Width (Default: 170)

Selects the RTTY shift width.

① When the internal RTTY decoder is used, 170 Hz is automatically selected.

RTTY Keying Polarity (Default: Normal)

Selects the RTTY keying polarity.

- Normal: Key open/close = Mark/Space
- Reverse: Key open/close = Space/Mark

MENU » SET > Function > **SPEECH****SPEECH Language** (Default: English)



Sets the speech language to English or Japanese.

SPEECH Speed (Default: Fast)

Sets the speech speed to Fast or Slow.

S-Level SPEECH (Default: ON)

Turns the S-meter level announcement ON or OFF.

- OFF: The operating mode and the operating frequency are announced when you push .
- ON: The signal strength level, the operating mode, and the operating frequency are announced when you push .

MODE SPEECH (Default: OFF)





Turns the operating mode announcement ON or OFF.

- OFF: The selected operating mode is not announced even though you change it.
- ON: The selected operating mode is announced each time you change it.

SPEECH Level (Default: 50%)

Sets the Voice Synthesizer audio output level.

MENU » SET > Function**[SPEECH/LOCK] Switch** (Default: SPEECH/LOCK)Selects  action.

- SPEECH/LOCK: Pushing  turns ON the Voice Synthesizer function. Holding down  turns the Lock function ON or OFF.
- LOCK/SPEECH: Pushing  turns the Lock function ON or OFF. Holding down  turns ON the Voice Synthesizer function.

Lock Function (Default: MAIN DIAL)This function electronically locks **MAIN DIAL** or the panel display* to prevent accidental changes.* Keys and dials are also locked except for **AF**, **RF**, **SQL**, **POWER**, and .**Memo Pad Quantity** (Default: 5)

Sets the number of memo pad channels to 5 or 10.

MAIN DIAL Auto TS (Default: High)Sets the Auto Tuning Step function for **MAIN DIAL**. When rapidly rotating **MAIN DIAL**, the tuning step automatically changes according to the rotation speed.

- OFF: Auto tuning step is turned OFF.
- Low: Approximately two times faster.
- High: Approximately five times faster when the tuning step is set to 1 kHz or smaller. Approximately two times faster when the tuning step is set to 5 kHz or larger.

MIC Up/Down Speed (Default: Fast)

Selects the steps per second when changing an operating frequency by holding down the microphone's [UP]/[DN] key.

- Slow: Low speed (25 tuning steps/second)
- Fast: High speed (50 tuning steps/second)

Quick RIT/ Δ TX Clear (Default: OFF)Selects the **CLEAR** operation for the RIT and Δ TX functions.

- OFF: Holding down **CLEAR** for 1 second resets the RIT or Δ TX shift frequency.
- ON: Pushing **CLEAR** resets the RIT or Δ TX shift frequency.

Function

[NOTCH] Switch (SSB) (Default: Auto/Manual)
[NOTCH] Switch (AM) (Default: Auto/Manual)

Selects the Notch function used in the SSB or AM mode.

- Auto: Only the Auto Notch function can be used.
- Manual: Only the Manual Notch function can be used.
- Auto/Manual: Both the Auto and Manual Notch functions can be used.

SSB/CW Synchronous Tuning (Default: OFF)

Turns the Displayed Frequency Shift function ON or OFF. This function automatically shifts the frequency to match the CW pitch when the operating mode is toggled between SSB and CW.

- OFF: Turns OFF the function.
- ON: When the operating mode is changed between SSB and CW, the operating frequency shifts by the offset amount.

CW Normal Side (Default: LSB)

Selects the carrier point in the CW normal mode.

- LSB: Sets the carrier point to the LSB side.
- USB: Sets the carrier point to the USB side.

MENU » SET > Function > **Front Key Customize**

[VOX/BK-IN] (Default: VOX/BK-IN)
[AUTOTUNE] (Default: AUTOTUNE)
[△] (Default: M-CH UP)
[▽] (Default: M-CH DOWN)

The function assignments for the **[VOX/BK-IN]**, **[AUTOTUNE]**, **[▲]**, and **[▼]** keys on the front panel can be changed.

① See page 55 about the functions.

MENU » SET > Function > **MIC Key Customize**

[UP] (Default: UP (VFO: kHz))
[DN] (Default: DOWN (VFO: kHz))

The function assignments for the [UP] and [DN] keys on the microphone can be changed.

① See page 55 about the functions.

MENU » SET > **Function**

Screen Capture [POWER] SW (Default: OFF)

Assigns the Screen Capture function to **[POWER]**.

- OFF: **[POWER]** does not act as the Screen Capture key.
- ON: **[POWER]** acts as the Screen Capture key.

Screen Capture File Type (Default: PNG)

Sets the file format for the Screen Capture function to PNG or BMP.

Keyboard Type (Default: Full Keyboard)

Sets the keyboard entry type to Ten-Key or Full Keyboard.

Full Keyboard Layout (Default: English)

Sets the on-screen keyboard layout to English, German, or French.

Calibration Marker (Default: OFF)

Turns the reference frequency calibration marker ON or OFF.

REF Adjust

Adjusts the internal reference frequency.

NOTE: The default setting of "REF Adjust" may differ slightly, depending on each transceiver.

Function

The assignable key functions for Front Key:

Function	Description
VOX/BK-IN*	Push to turn the VOX function in the Voice operation modes and the Break-in function in the CW mode ON or OFF. ① This function can be assigned for only VOX/BK-IN .
AUTOTUNE	In the CW mode Push to automatically tune the operating frequency to a close-by signal. ① This function can be assigned for only AUTOTUNE .
M-CH UP	Push to scroll Memory channel up. ① This function can be assigned to only ▲ and ▼ .
M-CH DOWN	Push to scroll Memory channel down. ① This function can be assigned to only ▲ and ▼ .
RX-ANT	Push to turn the RX-ANT function ON or OFF.
APF*	Push to turn the APF function ON or OFF.
PRESET	Push to open the PRESET screen.
Voice/ Keyer/RTTY Memory 1	In the SSB, AM, or FM mode <ul style="list-style-type: none"> Push to transmit the voice audio recorded on the SD card once. Hold down for 1 second to repeatedly transmit the voice audio.
Voice/ Keyer/RTTY Memory 2	① If the voice audio is not saved in the Voice TX memory (T1 ~ T4), this function is disabled. In the CW mode <ul style="list-style-type: none"> Push to transmit the Keyer memory content once.
Voice/ Keyer/RTTY Memory 3	<ul style="list-style-type: none"> Hold down for 1 second to repeatedly transmit the memory content. ① If the Keyer memory content (M1 ~ M4) is not entered, this function is disabled.
Voice/ Keyer/RTTY Memory 4	In the RTTY mode Push to transmit the RTTY memory content once. ① If the RTTY memory content (RT1 ~ RT4) is not entered, this function is disabled.

* Hold down for 1 second to open its function menu.

The assignable key functions for MIC Key:

Function	Description
---	No function
UP	Push to increase the frequency (in 50 Hz steps*) or Memory channel. * When the Tuning Step function is ON, increases the frequency in the selected Tuning Step.
DOWN	Push to decrease the frequency (in 50 Hz steps*) or Memory channel. * When the Tuning Step function is ON, decreases the frequency in the selected Tuning Step.
UP (VFO: kHz)	Push to increase the frequency (in the selected Tuning Step) or Memory channel.
DOWN (VFO: kHz)	Push to decrease the frequency (in the selected Tuning Step) or Memory channel.
XFC	While holding down the key, the transceiver monitors signals.
VFO/MEMO	<ul style="list-style-type: none"> Push to select the VFO mode and the Memory mode. Hold down for 1 second to copy the Memory channel contents to the VFO.
BAND UP	<ul style="list-style-type: none"> Push to increase an operating band. Hold down for 1 second to recall the Band Stacking Register contents.
BAND DOWN	<ul style="list-style-type: none"> Push to decrease an operating band. Hold down for 1 second to recall the Band Stacking Register contents.
SPEECH	Push to announce the S-meter level, frequency, and operating mode. ① The announced information depends on the settings.
MODE	<ul style="list-style-type: none"> Push to select the operating mode. Hold down for 1 second to toggle USB and LSB, CW and CW-R, or RTTY and RTTY-R.

Function

The assignable key functions for MIC Key:

Function	Description
Voice/Keyer/RTTY Memory 1	<p>In the SSB, AM, or FM mode</p> <ul style="list-style-type: none"> • Push to transmit the voice audio recorded on the SD card once. • Hold down for 1 second to repeatedly transmit the voice audio.
Voice/Keyer/RTTY Memory 2	<p>① If the voice audio is not saved in the Voice TX memory (T1 ~ T4), this function is disabled.</p> <p>In the CW mode</p> <ul style="list-style-type: none"> • Push to transmit the Keyer memory content once. • Hold down for 1 second to repeatedly transmit the memory content.
Voice/Keyer/RTTY Memory 3	<p>① If the Keyer memory content (M1 ~ M4) is not entered, this function is disabled.</p>
Voice/Keyer/RTTY Memory 4	<p>In the RTTY mode</p> <p>Push to transmit the RTTY memory content once.</p> <p>① If the RTTY memory content (RT1 ~ RT4) is not entered, this function is disabled.</p>
TS	<ul style="list-style-type: none"> • Push to turn the Tuning Step function ON or OFF. • Hold down for 1 second to open the TS screen.
MPAD	<ul style="list-style-type: none"> • Push to sequentially call up the contents in the Memo Pads. • Hold down for 1 second to save the displayed contents into the Memo Pad.
SPLIT	<ul style="list-style-type: none"> • Push to turn the Split function ON or OFF. • Hold down for 1 second to turn ON the Quick Split function.
A/B	<ul style="list-style-type: none"> • Push to select the VFO A or VFO B. • Hold down for 1 second to set the displayed VFO's frequency to the VFO that is not displayed.
TUNER	<ul style="list-style-type: none"> • Push to turn the antenna tuner ON or OFF. • While "TUNE" is displayed, hold down for 1 second to start manual tuning.

Connectors

MENU » SET > Connectors > USB AF/IF Output

Output Select (Default: AF)

Selects the signal output from the [USB] port.

- AF: An AF signal is output.
- IF: A 12 kHz IF signal is output.

AF Output Level (Default: 50%)

Sets the AF output level of the [USB] port, when the "Output Select" of USB is set to "AF."

AF SQL (Default: OFF (Open))

Selects whether or not to output the audio from the [USB] port, depending on the squelch state, when the "Output Select" of USB is set to "AF."

- OFF (Open): The squelch is always open, regardless of the transceiver's squelch level.
- ON: The squelch opens and closes, according to the transceiver's squelch level.

AF Beep/Speech... Output (Default: OFF)

Sets the Beep and Speech audio output setting of the [USB] port, when the "Output Select" of USB is set to "AF."

- OFF: The beep and speech audio are not output.
- ON: The beep and speech audio are output.

IF Output Level (Default: 50%)

Sets the IF output level of the [USB] port, when the "Output Select" of USB is set to "IF."

Connectors

MENU » SET > Connectors > **ACC AF/IF Output****Output Select** (Default: AF)

Selects the signal output from the [ACC] port.

- AF: An AF signal is output.
- IF: A 12 kHz IF signal is output.

AF Output Level (Default: 50%)

Sets the AF output level of the [ACC] port, when the "Output Select" of ACC is set to "AF."

AF SQL (Default: OFF (Open))

Selects whether or not to output the audio from the [ACC] port, depending on the squelch state, when the "Output Select" of ACC is set to "AF."

- OFF (Open): The squelch is always open, regardless of the transceiver's squelch level.
- ON: The squelch opens and closes, according to the transceiver's squelch level.

AF Beep/Speech... Output (Default: OFF)

Sets the Beep and Speech audio output setting of the [ACC] port, when the "Output Select" of ACC is set to "AF."

- OFF: The beep and speech audio are not output.
- ON: The beep and speech audio are output.

IF Output Level (Default: 50%)

Sets the IF output level of the [ACC] port, when the "Output Select" of ACC is set to "IF."

MENU » SET > Connectors > **LAN AF/IF Output****Output Select** (Default: AF)

Selects the signal output from the [LAN] port.

- AF: An AF signal is output.
- IF: A 12 kHz IF signal is output.

AF SQL (Default: ON)

Selects whether or not to output the audio from the [LAN] port, depending on the squelch state, when the "Output Select" of LAN is set to "AF."

- OFF (Open): The squelch is always open, regardless of the transceiver's squelch level.
- ON: The squelch opens and closes, according to the transceiver's squelch level.

MENU » SET > Connectors > **MOD Input****USB MOD Level** (Default: 50%)**ACC MOD Level** (Default: 50%)**LAN MOD Level** (Default: 50%)

Sets the modulation input level of each interface.

DATA OFF MOD (Default: MIC,USB)

In the SSB, AM, or FM mode, selects the connector(s) to input the modulation signal when the Data mode is OFF.

DATA MOD (Default: USB)

In the SSB, AM, or FM mode, selects the connector(s) to input the modulation signal when the Data mode is ON.

- ① Touching the [DATA] key in the MODE screen activates the Data mode, and automatically sets the modulation input to the "MIC," "USB," "ACC," "MIC, USB," "MIC, ACC," or "LAN" connector(s) selected in this item, for the Data mode.

MENU » SET > Connectors > **External Keypad****VOICE** (Default: OFF)

Enables voice memory transmission using an external keypad.

KEYER (Default: OFF)

Enables keyer memory transmission using an external keypad.

RTTY (Default: OFF)

Enables RTTY memory transmission using an external keypad.

Connectors

MENU » SET > Connectors > **CI-V**

CI-V Baud Rate (Default: Auto)

Selects the CI-V data transfer rate.

- ① When "Auto" is selected, the baud rate is automatically set according to the data rate of the connected device.
- ② This setting is used for only the behavior of the [REMOTE] jack.

CI-V Address (Default: B6h)

Sets the CI-V address.

- ① "B6h" is the default address of the IC-7300MK2.

CI-V Transceive (Default: ON)

Turns the Transceive function ON or OFF.

- OFF: The status is not output.
- ON: The status is output. When you change a setting on the transceiver, the same change is automatically set on other connected transceivers or receivers, and vice versa.

USB/LAN→REMOTE Transceive Address (Default: 00h)

Sets the address used to remotely control the transceiver using the optional RS-BA1 software, through the [USB] port or the [LAN] port.

The external equipment control signal is output from the [REMOTE] jack.

CI-V Output (for ANT) (Default: OFF)

Enables outputting the antenna controller status (frequency and so on) from the [REMOTE] jack.

- ① Address "01h" is reserved.
The usable addresses are limited to 02h ~ DFh.

CI-V USB (A) Echo Back (Default: OFF)

CI-V USB (B) Echo Back (Default: OFF)

Turns the Data Echo Back function ON or OFF, when remotely controlling the IC-7300MK2 through the [USB] port.

MENU » SET > Connectors

USB (B) Function (Default: RTTY Decode)

The transceiver has 2 virtual COM ports, A and B. This item sets the function to be assigned to virtual COM port B.

- ① Virtual COM port A is used for CI-V operation.
- ② When connecting the [USB] port to your PC, the ports are virtually named "IC-7300MK2 Serial Port A (CI-V)" and "IC-7300MK2 Serial Port B."
- RTTY Decode: Outputs the decoded data of the RTTY signal.
- CI-V: Inputs or outputs CI-V commands.

SEND Relay Output (Default: OFF)

Select "ON" when a non-Icom linear amplifier is connected to the transceiver.

MENU » SET > Connectors > **USB SEND/Keying**

TIP: This is the setting for the terminal used for data communication when you operate the transceiver using software on a PC.

The transceiver has 2 virtual COM ports, A and B. When connecting the [USB] port to your PC, the ports are virtually named "IC-7300MK2 Serial Port A (CI-V)" and "IC-7300MK2 Serial Port B."

USB SEND (Default: OFF)

Sets the USB terminal of the transceiver to receive the SEND signal from the software on the PC. Select the same terminal as the terminal set by the software.

- ① You cannot select the terminal which is already selected in the "USB Keying (CW)" or "USB Keying (RTTY)" item.

USB Keying (CW) (Default: OFF)

Sets the USB terminal of the transceiver to receive the CW Keying signal from the software on the PC. Select the same terminal as the terminal set by the software.

- ① You cannot select the terminal which is already selected in the "USB SEND" or "USB Keying (RTTY)" item.

USB Keying (RTTY) (Default: OFF)

Sets the USB terminal of the transceiver to receive the RTTY Keying signal from the software on the PC. Select the same terminal as the terminal set by the software.

- ① You cannot select the terminal which is already selected in the "USB SEND" or "USB Keying (CW)" item.

MENU » SET > Connectors

PTT Port Function (Default: PTT Input)

Set the behavior of the PTT pin on the [MIC] connector.

- PTT Input:
While transmitting, the transceiver does not output the SEND signal (TX status) from the PTT pin, but detects the PTT input (PTT operation) on the microphone.
- PTT Input + SEND Output:
While transmitting using other than the operating microphone, the transceiver does not detect the PTT input (PTT operation) of the microphone, due to the output SEND signal from the PTT pin.

Network

* This setting is valid after restarting the transceiver.

MENU » **SET > Network**

DHCP* (Default: ON)

Turns the DHCP function ON or OFF.

- OFF: Uses static IP addresses.
- ON: Uses the DHCP function. If a DHCP server is in your network environment, the IP addresses are automatically obtained.

① When this function is ON, you can check the settings assigned by the DHCP server by touching "IP Information" on the QUICK MENU screen.

IP Address* (Default: 192.168.0.10)

Sets a static IP address.

① You cannot set the same address as "Default Gateway."

Subnet Mask* (Default: 255.255.255.0(24 bit))

Sets the subnet mask to connect to your PC or Local Area Network (LAN), through your router.

Default Gateway* (Default:)

Sets the Default Gateway of the IC-7300MK2.

- ① A Default Gateway setting is required when:
- Remotely controlling the IC-7300MK2.
 - Using the NTP function.

Primary DNS Server* (Default:)

Sets the Primary DNS Server address.

Secondary DNS Server* (Default:)

If there are two DNS server addresses, sets the secondary DNS server address.

Network Name

If you are operating the IC-7300MK2 using the optional RS-BA1, enter a network name of up to 15 characters.

MENU » **SET > Network > Remote Settings**

Network Control* (Default: OFF)

Selects whether or not to remotely control the IC-7300MK2.

- OFF: Disables remote control of the IC-7300MK2.
- ON: Enables remote control of the IC-7300MK2.

Power OFF Setting (for Remote Control)* (Default: Only Shutdown)

Selects whether or not to display the Standby/Shutdown option dialog after holding down **POWER** for 1 second.

- Only Shutdown:
Shuts down the transceiver when you turn it OFF.
- Standby/Shutdown:
Displays the Standby/Shutdown option dialog when you turn it OFF.

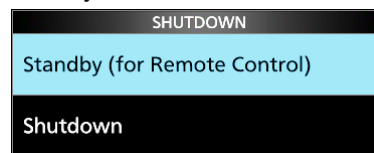

① When in the Standby mode, the indicator on **POWER** blinks orange.

Control Port (UDP)* (Default: 50001)

Sets a port number for the control signal transfers between the IC-7300MK2 and the remote station, when you remotely control the IC-7300MK2.

Serial Port (UDP)* (Default: 50002)

Sets a port number for the serial data transfers between the IC-7300MK2 and the remote station, when you remotely control the IC-7300MK2.

Audio Port (UDP)* (Default: 50003)

Sets a port number for the audio signal transfers between the IC-7300MK2 and the remote station, when you remotely control the IC-7300MK2.

Internet Access Line* (Default: FTTH)

Selects the Internet access line setting for the IP remote control.

Network

MENU » SET > Network > Remote Settings >
Network User1

MENU » SET > Network > Remote Settings >
Network User2

Network User1 ID
Network User2 ID

Sets a user name of up to 16 characters to use when you remotely control the IC-7300MK2.

Network User1 Password
Network User2 Password

Sets a user password.

- ① The password must include a minimum of 8 characters and a maximum of 16 characters.
- ① You cannot use a password that consists of only the same characters.

Network User1 Administrator (Default: NO)
Network User2 Administrator (Default: NO)

Selects whether or not to set the user as an administrator.

Only an authorized user can disconnect communication between the IC-7300MK2 and the remote station.

MENU » SET > Network > Remote Settings

Network Radio Name (Default: IC-7300MK2)

Sets the IC-7300MK2's name of up to 16 characters that is displayed in the remote control software, when you remotely control the IC-7300MK2.

Display

MENU » SET > Display

LCD Backlight (Default: 50%)

Sets the LCD backlight brightness.

Display Type (Default: A)

Sets the display type to A or B.

Display Font (Default: Round)

Selects the font for the frequency readout.

Meter Peak Hold (Default: ON)

Turns the Meter Peak Hold function ON or OFF.

Memory Name (Default: ON)

Turns the Memory name display in the Memory mode ON or OFF.

MN-Q Popup (MN OFF→ON) (Default: ON)

Selects whether or not to display the Manual Notch filter width when you select the Manual Notch.

BW Popup (PBT) (Default: ON)

Selects whether or not to display the PBT shift value while rotating **TWIN PBT CLR**.

BW Popup (FIL) (Default: ON)

Selects whether or not to display the IF filter width and shift value when you switch the IF filter by touching the filter icon.

Screen Saver (Default: 60min)

Sets the Screen Saver function.

This function activates and automatically turns OFF the screen when no operation is performed for the preset period of time.

MENU » SET > Display > External Display

External Display (Default: ON)

Select "ON" when an external display is connected to [HDMI].

External Display Resolution (Default: 1280x720)

Selects the screen resolution of the external display.

Display

Audio Output (Default: OFF)

Selects whether the received audio and the Confirmation beep are output from the transceiver, or the external display or speaker.

- OFF: The received audio and the Confirmation beep are output from the transceiver.
- ON: When an external display or speaker is connected to [HDMI], the received audio and the Confirmation beep are output from the external display or speaker.
 - ① While headphones are connected, the internal speaker, [EXT-SP] jack, and [HDMI] port are deactivated.

MENU » **SET > Display**

Opening Message (Default: ON)

Selects whether or not to display the opening message at power ON.

My Call

Sets a text displayed as the opening message, up to 10 characters. (Example: your call sign)

Power ON Check (Default: ON)

Selects whether or not to display the RF Power level at power ON.

Display Language (Default: English)

① This item is displayed only when the “System Language” item is set to “Japanese.”

Sets the screen display language type to English or Japanese.

System Language (Default: English)

Sets the system language of the transceiver.

- English: The system language of the transceiver is English. Only alphabetical characters (A to Z, a to z, 0 to 9) and symbols (! “ # \$ % & ‘ () * + , - . / : ; < = > ? @ [\] ^ _ ` { | } ~) can be displayed. If Japanese characters (Kanji, Hiragana, and Katakana) are included, the display shows “=” or “_” instead of that character. In that case, you can only delete “=” or “_” in the transceiver’s edit mode.
- Japanese: The system language of the transceiver is Japanese. Kanji, Hiragana, and Katakana characters, and the 2-bytes symbols can be displayed. To display such characters in the Menu mode, set “Display Language” to “Japanese.”

① When this item is set to “English,” “Display Language” is not displayed.

When you set the system language of the transceiver to Japanese, the transceiver has the capability to display both English and Japanese characters. HOWEVER, if you select Japanese, all menu items throughout the transceiver system will be displayed in only Japanese characters.

There will be no English item names. Unless you are fluent in reading Japanese characters, use this feature with extreme caution.

If you have changed the transceiver’s language to Japanese and do not understand the menu system in the new setting, you will have to change the language back to English by doing a partial reset of the transceiver CPU. A partial reset will not clear your call sign databases.

To do a partial reset of the CPU, do the following steps:

1. Push **MENU**.
2. Touch [SET].
3. Touch the item (with the “etc” icon) shown below.



4. Touch the item shown below.

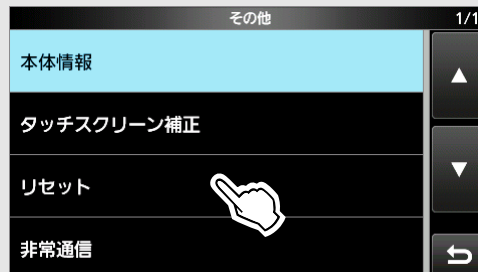

5. Touch the upper item shown below.



6. Touch the left item.

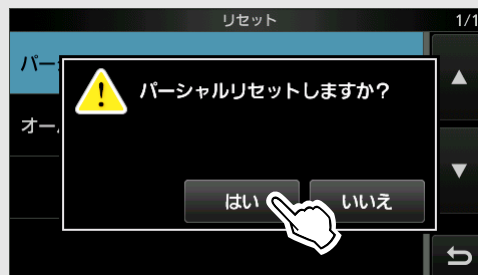

- The transceiver displays “PARTIAL RESET,” then the partial reset is completed.

Time Set

MENU » SET > Time Set > **Date/Time**

Date

Sets the date (Year/Month/Day).

① The day of the week is automatically set.

Time

Sets the current time.

① The time is displayed in the 24 hour format.

<<NTP TIME SYNC>>

Synchronizes the internal clock with the time management server.

① To use this function, you need an Internet connection and default gateway settings.

NTP Function (Default: ON)

Automatically obtains the current time from the NTP server.

NTP Server Address (Default: time.nist.gov)

Sets the NTP server address.

MENU » SET > Time Set

UTC Offset (Default: ±0:00)

Sets the UTC offset time.

- Set to between -14:00 ~ +14:00 in 5-minute steps.

SD Card

MENU » SET > SD Card

Load Setting

Selects the saved data file to load.

Save Setting

Saves the setting data onto an SD card.

SD Card Info

Displays the SD card capacity and the time remaining for voice recording.

Screen Capture View

Displays the selected screen capture.

Firmware Update

Displays the Firmware Update mode.

Format

Formats the SD card.

If you use a brand new SD card, be sure to format it in the transceiver.

Unmount

Unmounts the SD card.

Before you remove a card when the transceiver is ON, be sure to electrically unmount it. Otherwise, the data may be corrupted or deleted.

Others

MENU » SET > Others > **Information**

Version

Displays the transceiver firmware's version number.

MAC Address

Displays the MAC address used in this transceiver.

MENU » SET > **Others**

Touch Screen Calibration

Calibrates the touch screen.

① See the Advanced manual for details.

MENU » SET > Others > **Reset**

Partial Reset

Resets operating settings to their default values (VFO frequency, VFO settings, and menu contents).

① See page 66 for details.

All Reset

Clears all data and returns all settings to their factory defaults. Memory channel contents, filter settings, and so on will all be cleared, so you will need to re-enter your operating settings.

① See page 66 for details.

MENU » SET > **Others**

Emergency

Enters the Emergency mode by touching "Tuner."

① See page 48 for details.

Setting the date and time

◇ Setting the date

1. Open the “Date” screen.

MENU » SET > Time Set > Date/Time > **Date**

2. Touch [+] or [-] to set the date.
3. Touch [SET] to save the date.

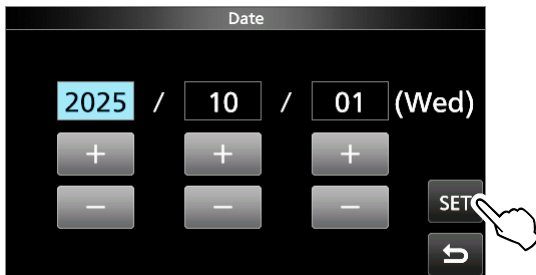

- Returns to the previous screen.
 - ① To cancel the editing, touch **↩**.
4. To close the DATE/TIME screen, push **EXIT** several times.

◇ Setting the current time

1. Open the “Time” screen.

MENU » SET > Time Set > Date/Time > **Time**

2. Touch [+] or [-] to set the current time.
3. Touch [SET] to save the time.

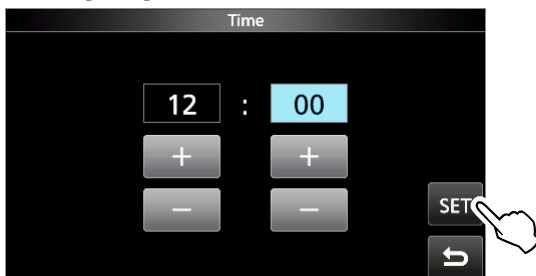

- Returns to the previous screen.
 - ① To cancel the editing, touch **↩**.
4. To close the DATE/TIME screen, push **EXIT** several times.

◇ Setting the UTC offset

1. Open the “UTC Offset” screen.

MENU » SET > Time Set > **UTC Offset**

2. Touch [+] or [-] to set the UTC offset.
3. Touch **↩** to save the UTC offset.

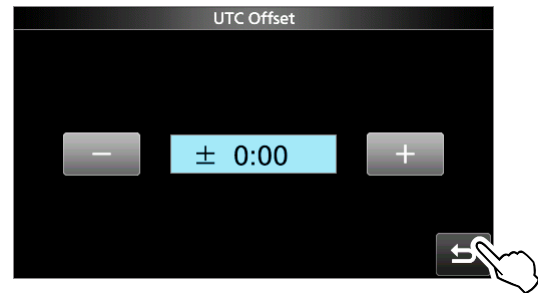

- Returns to the previous screen.
4. To close the TIME SET screen, push **EXIT** several times.

NOTE: The backup battery for the internal clock

The IC-7300MK2 has a rechargeable Lithium battery to back up the internal clock. If you connect the transceiver to a power source, the battery is charged, and it keeps the correct clock setting. However, if you do not connect the transceiver to a power source for a long period of time, the battery will discharge. In that case, the transceiver resets the internal clock.

If you do not use the transceiver for a long period of time, we recommend that you connect the transceiver to a power source at least once a month. The charging period is two days whether the transceiver's power is ON or OFF.

Cleaning



DO NOT use harsh solvents such as benzene or alcohol when cleaning, because they will damage the transceiver surfaces.



If the transceiver becomes dusty or dirty, wipe it clean with a dry, soft cloth.

Replacing fuses

If a fuse blows, or the transceiver stops functioning, find and repair the cause of the problem. Then replace the damaged fuse with a new, adequately rated fuse.
 Ⓛ Spare fuses are supplied with the transceiver.

The fuses are installed in the DC power cable and in the inside circuitry, to protect the transceiver.

- DC power cable fusesATC 32 V 25 A
 For European versionsATC 32 V 30 A
- Circuitry fuseAPS 58 V 5 A

⚠ WARNING!

- Disconnect the DC power cable from the transceiver before replacing the fuse.
- **NEVER** use fuses that are not specified.

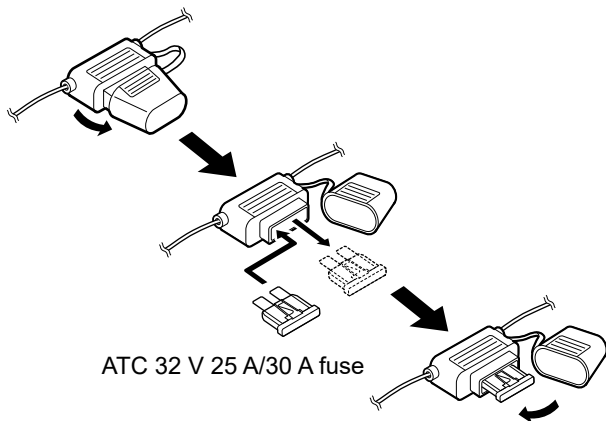

Fuse Coding explanation for the European versions

Fuse Coding: FUSE 32 V 30 A
 Fuse Voltage Rating: 32 Volts
 Fuse Current Rating: 30 Amperes

1. Remove the 14 screws, then remove the cover.

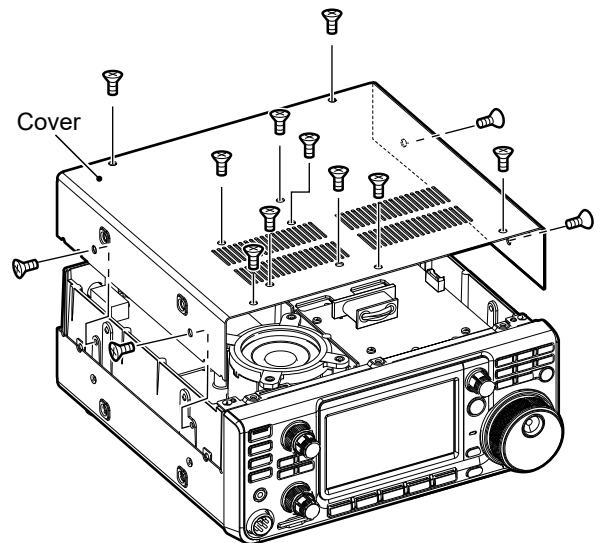

2. Replace the circuitry fuse as shown below.

CAUTION: When you remove a fuse, use longnose pliers to protect your fingers and the fuse holders.

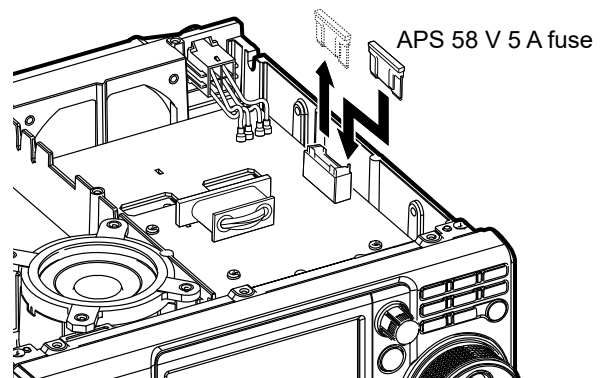

3. Replace the cover and the screws.

Resetting

Occasionally, erroneous information may be displayed. This may be caused by static electricity or by other factors. If this problem occurs, turn OFF the transceiver. After waiting a few seconds, turn ON the transceiver again.

If the problem still exists, perform a **Partial reset**, as described to the right.

If the problem still exists after a Partial reset, perform an **All reset**, also described to the right.

NOTE: An All reset clears all data and returns all settings to their factory defaults. Save memory channel content, setting status, and so on, onto an SD card before an All reset. See the Advanced manual for details.

After performing a Partial reset

A Partial reset resets operating settings to their default values (VFO frequency, VFO settings, menu contents) without clearing the items listed below:

- Memory channel/Keyer memory/RTTY memory/ Preset memory contents
- Internal antenna tuner preset points
- Network settings
- REF Adjust
- My Call
- User Band Edges
- Fixed Edges

After performing an All reset

An All reset clears all data and returns all settings to their factory defaults. Memory channel contents, filter settings, and so on will all be cleared, so you will need to re-enter your operating settings unless you have a backup.

- ① The internal antenna tuner preset points are not cleared. You can clear them in the following item.

MENU » SET > Function > Tuner > <<Preset Memory Clear>>

When you cannot enter the Set mode

If a touch screen operation error or an unexpected operation occurs, you cannot enter the Set mode. In this case, perform an All reset, as described below:

1. Turn OFF the transceiver.
 2. While holding down **CLEAR** and **V/M**, push **POWER**.
- ① If you cannot turn the transceiver ON or OFF by using **POWER**, perform an All reset by connecting an external power source while holding down **CLEAR** and **V/M**.

◇ Partial reset

1. Open the RESET screen.

MENU » SET > Others > Reset

2. Touch "Partial Reset."

- The confirmation screen is displayed.



3. Touch [YES].

- ① After resetting, the default VFO mode screen is displayed.

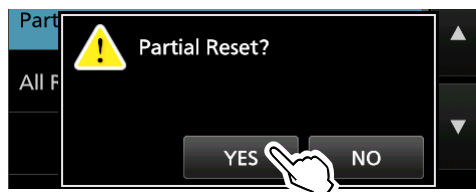

◇ All reset

1. Open the RESET screen.

MENU » SET > Others > Reset

2. Touch "All Reset."

- The confirmation screen is displayed.



3. Touch [NEXT].



4. After carefully reading the displayed message, touch [YES] to perform the All reset.

- ① After resetting, the default VFO mode screen is displayed.



Troubleshooting

The following chart is designed to help you solve problems that are not equipment malfunctions. If you are unable to locate the cause of a problem or solve it through the use of this chart, contact your nearest Icom Dealer or Service Center.

① “AM” indicates the PDF type Advanced manual.

Problem	Possible cause	Solution	Ref.
● Transceiver power			
Power does not turn ON when POWER is pushed.	The DC power cable is not connected properly.	Reconnect the DC power cable properly.	p. 20
	The external power supply is turned OFF.	Turn ON the external power supply.	–
	The DC power cable fuses or circuitry fuse are blown.	Find and repair the cause of the problem, and then replace the damaged fuse with a new one.	p. 65
● Receiving			
No sound is heard from the speaker.	The audio level is too low.	Rotate (AF↔RF/SQL) (inner) clockwise to obtain a suitable listening level.	p. 22
	The squelch is closed.	Rotate (AF↔RF/SQL) (outer) to the 12 o'clock position to open the squelch.	p. 26
	Headphones are connected.	Disconnect the headphones.	p. 12
	When an external display with internal speakers is connected to the transceiver, the audio output is switched to the external display's speakers.	Select “OFF” in the “Audio Output” item.	p. 61
	In the FM mode, the Tone Squelch function is turned ON.	Turn OFF the Tone squelch.	AM
	The external speaker cable is defective.	Check the external speaker cable and repair it.	–
	The transceiver is switched to transmit. (The TX/RX indicator lights red, and TX is displayed.)	Release [PTT] or push [TRANSMIT] to return to receive.	p. 28
Sensitivity is too low, and only strong signals are heard.	The Attenuator is activated.	Turn OFF the Attenuator.	p. 29
	RF gain control is set too low. (“RFG” is displayed.)	Set the RF gain higher until “RFG” just goes off.	p. 26
	The squelch is closed.	Rotate (AF↔RF/SQL) (outer) to the 12 o'clock position to open the squelch.	p. 26
	The antenna or coaxial cable is defective.	Repair the problem and then reconnect the antenna.	–
	An antenna is connected to the incorrect antenna connector.	Check the antenna connector.	p. 76
	The incorrect antenna connector is selected.	Turn OFF the receive antenna connectors ([RX-ANT IN] and [RX-ANT OUT]).	p. 28
	You are using an antenna that is not suitable for the band you have selected.	Connect an antenna suitable for the operating band.	–
The transceiver automatically switches to transmit while receiving.	The VOX function is ON.	Push (VOX/BK-IN) to turn OFF the VOX function.	AM
	The VOX gain is set too high.	Adjust the VOX gain.	
	The transceiver receives the SEND signal from the software on the PC.	Confirm the “USB SEND” setting.	p. 58

Troubleshooting

Problem	Possible cause	Solution	Ref.
The received audio in the SSB mode is unclear or distorted.	The incorrect sideband is selected.	Toggle between USB and LSB.	p. 23
	The PBT function is activated.	Hold down (TWIN PBT CLR) for 1 second to clear the PBT settings.	p. 32
"OVF" is displayed.	An excessively strong signal is being received.	Set the RF gain lower. ("RFG" is displayed.)	p. 26
		Turn ON the Attenuator.	p. 29
		Turn OFF the Preampifier.	p. 29
The spectrum scope's sensitivity is too low, and no signal or only strong signals are displayed.	The reference level is too low.	Set the reference level to a higher level.	AM
The audio is intermittent.	The internal reference frequency has shifted.	Adjust the internal reference frequency in "REF Adjust."	AM
● Transmitting			
The transceiver cannot switch to transmit.	The operating frequency is outside a ham band.	Set the frequency to a ham band.	p. 24
	In the CW mode, the Break-in function is turned OFF.	Turn ON the function before starting keying.	p. 38
No power output or the output power is too low.	The operating frequency is outside a ham band.	Set the frequency to a ham band.	p. 24
	The transmit output power is set too low.	Adjust the RF POWER in the Multi-function menu.	p. 27
	The modulation input signal level is set too low.	Adjust the microphone gain in the Multi-function menu.	p. 27
	The microphone is bad, or the [MIC] connector is shorted or defective.	Test the microphone and check the [MIC] jack.	p. 75
	The antenna is not properly tuned.	Hold down (TUNER) for 1 second to tune the antenna.	p. 46
	The antenna SWR is more than 3:1.	Adjust the antenna for an SWR of less than 3:1.	AM
The transmit signal is unclear or distorted in the SSB mode.	The transceiver's microphone gain is too high.	Adjust the MIC GAIN level so that the meter reading swings between 30 and 50% of the ALC scale.	p. 27
Under modulation occurs.	In the AM or FM mode, the transceiver's microphone gain is too low.	Adjust the MIC GAIN level in the Multi-function menu.	p. 27
	Cannot contact with another station even if receiving and transmitting seem successful.	The Split function is ON, and the transmit and receive frequencies differ. ((SPLIT) is displayed.)	Push (SPLIT) to turn OFF the Split function.
Cannot transmit voice memories.	The RIT or ΔTX function is ON, and the transmit and receive frequencies differ. ("RIT" or "ΔTX" is displayed.)	Push (RIT) or (ΔTX) to turn OFF the function.	p. 29, AM
		"DATA OFF MOD" is set to "USB," "ACC," or "LAN" by control from an external device, and so on.	Set "DATA OFF MOD" to "MIC, USB" (default), "MIC," or "MIC, ACC."
The antenna SWR is too high.	The antenna is not properly tuned.	Adjust the antenna SWR. The antenna SWR should be less than 3.	–
	The coaxial cable is not suitable or is damaged.	Replace with a good coaxial cable whose characteristic impedance is 50 Ω.	–

Troubleshooting

Problem	Possible cause	Solution	Ref.
● VFO mode			
A Programmed scan does not start.	The VFO mode is not selected.	Select the VFO mode.	p. 22
	The same frequencies have been set in the scan edge memory channels P1 and P2.	Set different frequencies in scan edge memory channels P1 and P2.	AM
● Memory mode			
A Memory scan does not start.	The Memory mode is not selected.	Select the Memory mode.	p. 22
	No, or only 1 memory channel is set.	Set at least 2 memory channels.	AM
A Select memory scan does not start.	No, or only 1 memory channel is assigned as a Select channel.	Assign at least 2 memory channels as Select channels for the scan.	AM
While operating in the Memory mode, you changed the operating frequency, mode, and so on, but the selected memory channel contents are not changed.	The operating frequency, mode, and so on were not written into the selected memory.	When you want to save the changed settings, touch [MW] for 1 second to write them into the memory channel on the VFO/MEMORY screen.	AM
● Time			
The current time is reset.	The transceiver has not been used for a long time with the DC power cable disconnected.	Connect the transceiver to the power supply for 2 days (approximate) to charge the backup battery of the internal clock.	p. 64
Even when turning ON the NTP function, the clock is not automatically set.	The transceiver is not connected to a network.	Confirm the [LAN] port connection.	p. 76
		Confirm the network settings.	p. 59
	The transceiver IP address is incorrect.	Turn ON the DHCP function to automatically get the IP address, or set the correct IP address.	p. 59
● SD card			
"No SD Card is found." is displayed.	An SD card is not recognized.	Confirm that an SD card is inserted.	p. 44
		Reinsert the SD card.	
		Exchange with a new SD card.	
"– No File –" is displayed on the FIRMWARE UPDATE screen.	The firmware file is in the incorrect folder.	Copy the firmware file into the IC-7300MK2 folder.	AM
	The firmware file name is different.	Download the firmware file again.	
	The SD card drive is not formatted.	Format the SD card.	p. 45
Cannot save TX/RX histories or sound data.	An SD card is not inserted.	Insert an SD card.	p. 44
● Others			
The operating frequency does not change when rotating MAIN DIAL .	The Dial Lock function is ON.	Hold down SPEECH for 1 second to turn OFF the Dial Lock function.	p. 27
Even if touching "<<REC Start>>," ■■ is displayed.	No signal is received, or [AF RF/SQL] (outer) is rotated to fully clockwise.	Rotate [AF RF/SQL] (outer) to 12 o'clock to receive weak signals.	p. 26
The display turns OFF.	The Screen Saver function is ON. (The indicator on POWER blinks blue.)	Operate something (push a key, and so on) to reset the screen saver startup time.	p. 60
Cannot hear the speech after pushing SPEECH .	The speech level is too low.	Adjust "SPEECH Level" in the Speech setting.	p. 53
The touch screen is not working correctly.	The touched point and the detected point may be different.	Calibrate the touch screen on the OTHERS screen.	AM

11 SPECIFICATIONS

◇ General

- Frequency coverage (unit: MHz):
 - Receiver 0.030000 ~ 74.800000*
 - Transmitter
 - 1.800000 ~ 1.999999*
 - 3.500000 ~ 3.999999*
 - 5.255000 ~ 5.405000
 - 7.000000 ~ 7.300000*
 - 10.100000 ~ 10.150000
 - 14.000000 ~ 14.350000
 - 18.068000 ~ 18.168000
 - 21.000000 ~ 21.450000
 - 24.890000 ~ 24.990000
 - 28.000000 ~ 29.700000
 - 50.000000 ~ 54.000000*
 - 70.000000 ~ 70.500000* (For only the European versions)
- * The frequency coverage and guaranteed ranges differ, according to the transceiver version.
- Operating modes: USB/LSB (J3E), CW (A1A), RTTY (F1B), AM (A3E), and FM (F3E)
- Number of memory channels: 101 (including 2 scan edges)
- Antenna impedance: 50 Ω Unbalanced
- Antenna connector: SO-239 × 1 (for the HF/50 MHz/70 MHz band)
SMA × 2 (for the HF/50 MHz/70 MHz band, RX only)
- Power supply requirement: 13.8 V DC (±15%)
- Operating temperature range: -10°C ~ +60°C, +14°F ~ +140°F
- Frequency stability: ±0.5 ppm or less (-10°C ~ +60°C, +14°F ~ +140°F)
- Frequency resolution: 1 Hz
- Power consumption:
 - Receive Standby 0.7 A (typical)
 - Maximum audio 1.25 A
 - Transmit Maximum power 21.0 A
- Dimensions (projections not included): 240 (W) × 94 (H) × 237.6 (D) mm, 9.44 (W) × 3.7 (H) × 9.35 (D) in
- Weight (approximate): 4.1 kg, 9.0 lb

◇ Transmitter

- Transmit output power:
 - HF and 50 MHz bands
 - SSB/CW/RTTY/FM 0.6 W ~ 100 W
 - AM 0.125 W ~ 25 W
 - 70 MHz band*
 - SSB/CW/RTTY/FM 0.3 W ~ 50 W
 - AM 0.075 W ~ 12.5 W
- * Depending on the transceiver version.
- Modulation system:
 - SSB Digital PSN modulation
 - FM Digital Reactance modulation
 - AM Digital Low power modulation
- Spurious emission:
 - Harmonics
 - 50 dB or less (1.8 ~ 28 MHz)
 - 63 dB or less (50 MHz band)
 - 60 dB or less (70 MHz band)
 - Out-of-band emission
 - 40 dB or less (1.8 ~ 28 MHz)
 - 60 dB or less (50 MHz band)
 - 60 dB or less (70 MHz band)
- Carrier suppression: 50 dB or more
- Unwanted sideband suppression: 50 dB or more
- Microphone impedance: 600 Ω

◇ Receiver

- Receive system: Direct sampling superheterodyne
- Intermediate frequency: 1st 12 kHz
- Sensitivity (Filter: SOFT):
 - SSB/CW (BW=2.4 kHz, 10 dB S/N)
 - 1.8 ~ 29.999999 MHz –16 dB μ V (0.16 μ V) or less
 - 50 MHz band –18 dB μ V (0.13 μ V) or less
 - 70 MHz band* –16 dB μ V (0.16 μ V) or less
 - AM (BW=6 kHz, 10 dB S/N)
 - 0.5 ~ 1.8 MHz +22 dB μ V (12.6 μ V) or less
 - 1.8 ~ 29.999999 MHz +6 dB μ V (2.0 μ V) or less
 - 50 MHz and 70 MHz bands 0 dB μ V (1.0 μ V) or less
 - FM (BW=15 kHz, 12 dB SINAD)
 - 28.0 ~ 29.7 MHz –6 dB μ V (0.5 μ V) or less
 - 50 MHz and 70 MHz bands –12 dB μ V (0.25 μ V) or less
- ① P.AMP1 is ON in the HF band, and P.AMP2 is ON in the 50 MHz and 70 MHz bands.
- Sensitivity for European versions (Filter: SOFT)
 - SSB (BW=2.4 kHz, 12 dB SINAD)
 - 1.8 ~ 2.999999 MHz +10 dB μ V emf or less
 - 3.0 ~ 29.999999 MHz 0 dB μ V emf or less
 - 50 MHz and 70 MHz bands –6 dB μ V emf or less
 - AM (BW=4 kHz, 60% Modulation, 12 dB SINAD)
 - 1.8 ~ 2.999999 MHz +16 dB μ V emf or less
 - 3.0 ~ 29.999999 MHz +6 dB μ V emf or less
 - 50 MHz and 70 MHz bands 0 dB μ V emf or less
 - FM (BW=7 kHz, 60% Modulation, 12 dB SINAD)
 - 28.0 ~ 29.7 MHz 0 dB μ V emf or less
 - 50 MHz and 70 MHz bands –6 dB μ V emf or less
- ① P.AMP1 is ON in the HF band, and P.AMP2 is ON in the 50 MHz and 70 MHz bands.
- Squelch sensitivity (threshold):
 - SSB +15 dB μ V (5.6 μ V) or less
 - FM –10 dB μ V (0.3 μ V) or less
- ① P.AMP1 is ON in the HF band, and P.AMP2 is ON in the 50 MHz and 70 MHz bands.
- Selectivity (Filter: SHARP):
 - SSB (BW=2.4 kHz)
 - 2.4 kHz or more/–6 dB
 - 3.4 kHz or less/–40 dB
 - CW (BW=500 Hz)
 - 500 Hz or more/–6 dB
 - 700 Hz or less/–40 dB
 - RTTY (BW=500 Hz)
 - 500 Hz or more/–6 dB
 - 800 Hz or less/–40 dB
 - AM (BW=6 kHz)
 - 6.0 kHz or more/–6 dB
 - 10 kHz or less/–40 dB
 - FM (BW=15 kHz)
 - 12.0 kHz or more/–6 dB
 - 22 kHz or less/–40 dB
- Spurious and image rejection:
 - SSB/CW/AM/FM
 - HF band 70 dB or more
 - 50 MHz and 70 MHz bands 70 dB or more (Except for ADC aliasing: 124.032 MHz – RX frequency)
- Audio output power: 2.5 W or more (8 Ω load, 1 kHz, 10% distortion)
- AF output impedance: 8 Ω
- RIT variable range: \pm 9.999 kHz

◇ Antenna tuner

- Tunable impedance range: 16.7 ~ 150 Ω (unbalanced) (3:1 VSWR or less)
- Tuning accuracy: 1.5:1 VSWR or less
- Tuning time (approximate):
 - 2 ~ 3 seconds (average)
 - 15 seconds (maximum)

① All stated specifications are typical and subject to change without notice or obligation.

12 OPTIONS

Options

(As of November 2025)

IC-PW2 LINEAR AMPLIFIER



HF/50 MHz all band 1 kW linear amplifier including an automatic antenna tuner. An optional OPC-599 is required for the connection.

AH-730 AUTOMATIC ANTENNA TUNER



An automatic antenna tuner to tune a long wire antenna for base, portable, or mobile HF/50 MHz operation.

AH-740 AUTOMATIC TUNING ANTENNA

High performance, automatic high-speed tuning antenna.

The optional AH-5NV NVIS KIT is available.



HM-219 MICROPHONE



The same as supplied.

SM-30 DESKTOP MICROPHONE



Desktop microphone with a low frequency cut function.

SM-50 DESKTOP MICROPHONE



Dynamic microphone with [UP]/[DOWN] switches.

SP-41 EXTERNAL SPEAKER



Designed for base station operation.

- **AH-710 FOLDED DIPOLE ANTENNA**
Covers 2 to 30 MHz wide frequency range.
Element length: 24.5 m (80.4 ft)
Coaxial cable (supplied): 30 m (98.4 ft)
- **MB-118 MOUNTING BRACKET**
To mount the transceiver inside a vehicle.
- **MB-123 CARRYING HANDLE**
- **OPC-599 ADAPTER CABLE**
13-pin ACC connector adapter to 7-pin + 8-pin ACC connectors.
- **RS-BA1 Version 2 IP REMOTE CONTROL SOFTWARE**
NOTE: To remotely control transceivers using the RS-BA1, BE SURE to comply with your local regulations.

- **SP-33 EXTERNAL SPEAKER**
Designed for base station operation.
- **SP-35 EXTERNAL SPEAKER**
Designed for mobile operation.
Cable length: 2 m, 6.6 ft
- **SP-35L EXTERNAL SPEAKER**
Designed for mobile operation.
Cable length: 6 m, 19.7 ft
- **SP-38 EXTERNAL SPEAKER**
Designed to match the IC-7300MK2.

Mounting the MB-118

Mount the optional MB-118 MOUNTING BRACKET to a place where it can be firmly attached.

① We recommend that you periodically check whether the screws are loose or not, especially after a long period of use.

NOTE:

- Before mounting the MB-118, carefully read PRECAUTIONS (p. 10) and decide on the mounting place.
- **DO NOT** use bolts other than those supplied with the MB-118. Other bolts (longer than 8 mm/0.31 inch) may damage the internal units.

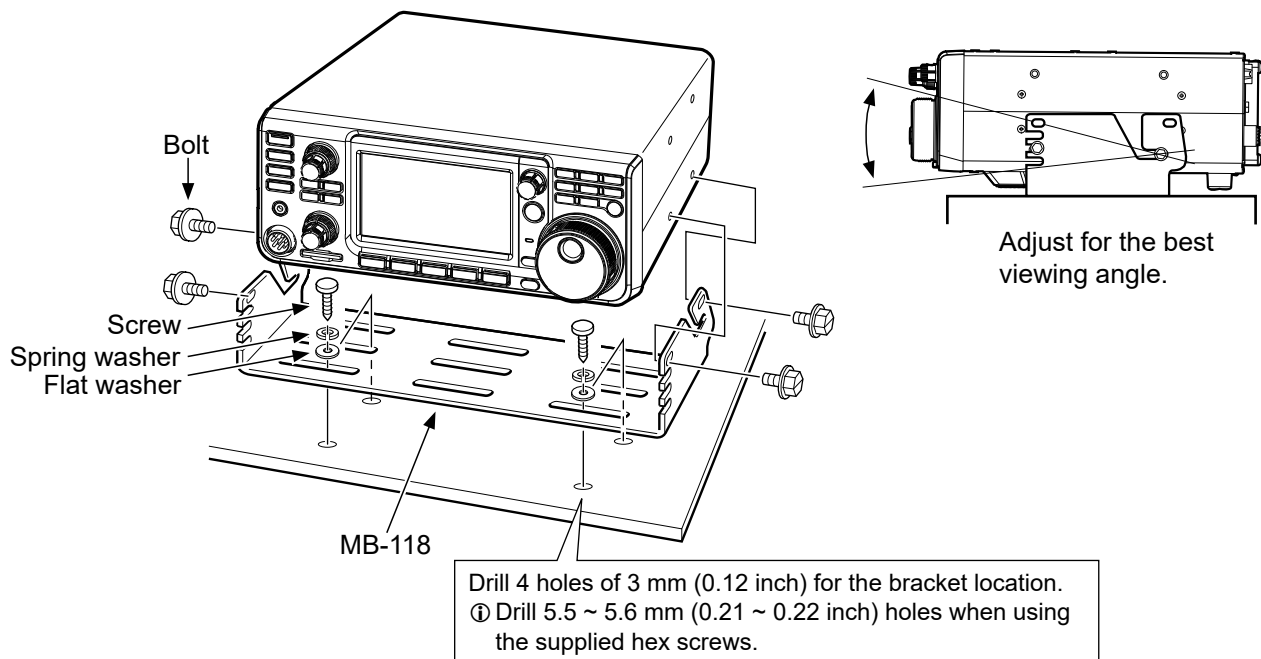

Attaching the MB-123

The optional MB-123 carrying handle with the rubber feet is convenient for carrying the transceiver.

1. Attach the rubber feet supplied with the MB-123 to the transceiver.
 - ① To firmly attach, push-in the center part of the rubber feet.
2. Attach the carrying handle using the supplied screws as shown below.

NOTE: DO NOT use screws other than the ones supplied with the MB-123.

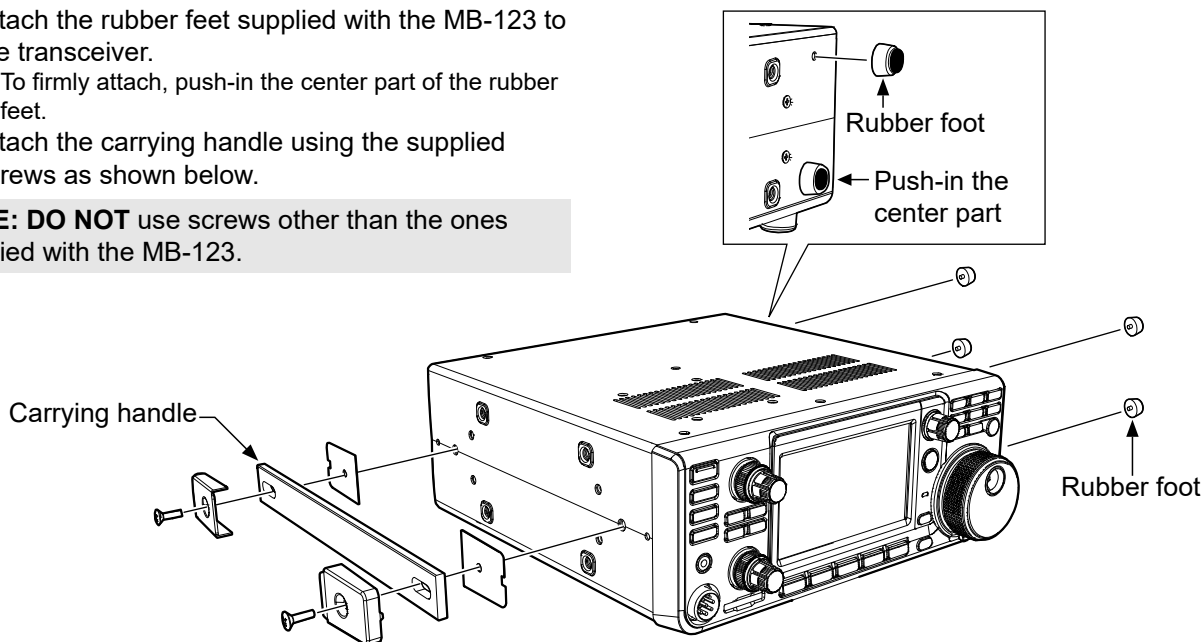

13 CONNECTOR INFORMATION

[ACC]

Connect to devices to control an external unit or to control the transceiver.

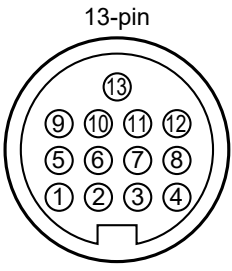
ACC	Pin No.	Name	Description	Specifications
 <p>13-pin</p> <p>Rear panel view</p> <p>① brown ⑧ gray ② red ⑨ white ③ orange ⑩ black ④ yellow ⑪ pink ⑤ green ⑫ light blue ⑥ blue ⑬ light green ⑦ purple</p> <p>① The color refers to the strands of the supplied cable.</p>	1	8 V	Regulated 8 V output. (Used as the reference voltage for the band voltage.)	Output voltage: 8 V ±0.3 V Output current: Less than 10 mA
	2	GND	Connect to ground.	—
	3	SEND*1	Input/output pin. An external unit controls the transceiver. When this pin goes to ground, the transceiver transmits. The pin goes low when the transceiver transmits.	Input voltage (RX): 2.0 ~ 20.0 V Input voltage (TX): -0.5 ~ +0.8 V Current flow: Maximum 20 mA
	4	BDT	Not used.	—
	5	BAND	Band voltage output. (Varies with the selected amateur band.)	Output voltage: 0 ~ 8.0 V
	6	ALC	ALC voltage input.	Input level: -6 ~ 0 V Input impedance: More than 3.3 kΩ
	7	NC	—	—
	8	13.8 V	13.8 V output when power is ON.	Output current: Maximum 1 A
	9	TKEY	Not used.	—
	10	FSKK	Controls RTTY keying.	High level: More than 2.4 V Low level: Less than 0.6 V Output current: Less than 2 mA
	11	MOD	Modulator input.	Input impedance: 10 kΩ Input level: 100 mV rms*2
	12	AF/IF (IF=12 kHz)*3	Fixed AF detector or receive IF (12 kHz) signal output.	Output impedance: 4.7 kΩ Output level: 100 ~ 300 mV rms*4
	13	SQL S	Squelch output. Grounded when the squelch opens.	SQL open: Less than 0.3 V/5 mA SQL closed: More than 6.0 V/100 μA

*1 When the SEND terminal controls an inductive load, such as a relay, a counter-electromotive force can malfunction or damage the transceiver. To prevent this, we recommend adding a switching diode, such as a 1SS133, on the load side of the circuit to absorb the counter-electromotive force.

① When the diode is added, a delay in relay switching may occur. Be sure to check its switching action before operating.

Example: ACC socket

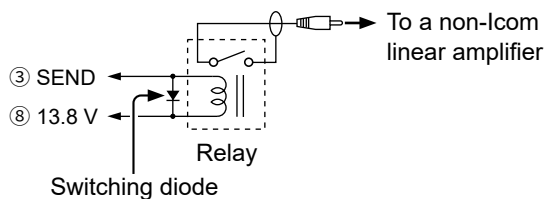

*2 You can change the MOD input level.

① 100 mV rms is at 50% as the default.

MENU » SET > Connectors > MOD Input > **ACC MOD Level**

*3 You can change the AF/IF (IF=12 kHz) settings to output a 12 kHz IF signal. In that case, you can listen to DRM communication with the application software receiver that is installed onto your PC.

MENU » SET > Connectors > ACC AF/IF Output > **Output Select**

*4 You can change the AF/IF (IF=12 kHz) output level.

① Approximately 200 mV rms is at 50% as the default.

MENU » SET > Connectors > **ACC AF/IF Output**

[ACC]

◇ OPC-599 ACC conversion cable pin assignments

The OPC-599 ACC conversion cable connects between a 13-pin [ACC] socket and 7-pin and 8-pin sockets.

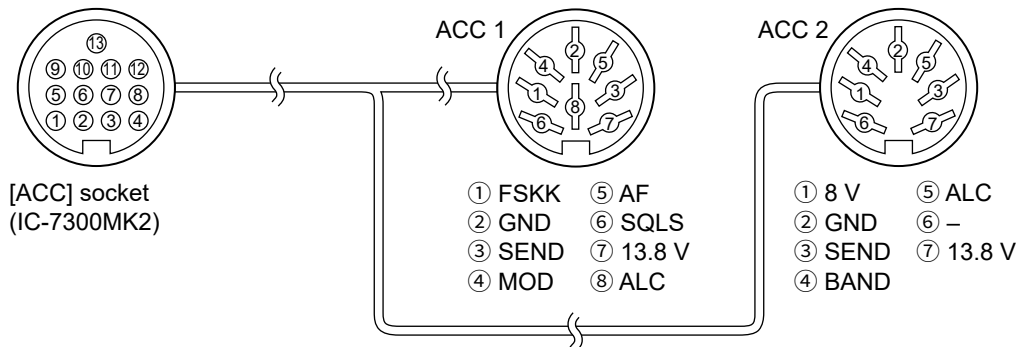

[MIC]

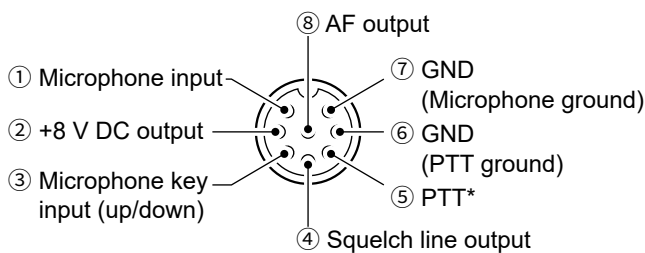

PIN No.	DESCRIPTION
①	Microphone input (Impedance: 600 Ω)
②	+8 V DC output (Maximum 10 mA)
③	Up: Ground Down: Ground through 470 Ω
④	Grounded when the squelch opens.
⑤	PTT*
⑥	PTT ground
⑦	Microphone ground
⑧	AF output (varies with the AF control.)

* To output the SEND signal from the PTT pin, set "PTT Port Function" to "PTT Input + SEND Output."

MENU » SET > Connectors > PTT Port Function

◇ External keypad

A circuit is used to output memory content from 4 memories. You can output desired memory content, such as that from a CW Memory keyer (M1 ~ M4), Voice memory (T1 ~ T4), or RTTY Memory (RT1 ~ RT4), to be transmitted.

- Push a switch to send the memory information.
- Hold down the switch for 1 second to repeatedly send the memory information.

① To use the external keypad, turn ON the following items on the CONNECTORS set screen. (p. 57)

MENU » SET > Connectors > External Keypad

- VOICE: ON
- KEYER: ON
- RTTY: ON

① The External keypad is not supplied by Icom. (User supplied)

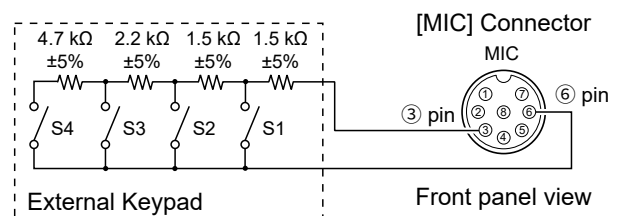

13

13 CONNECTOR INFORMATION

[DC 13.8 V]

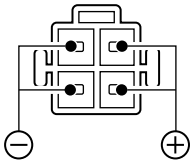

Connect to a regulated DC power source of 13.8 V DC $\pm 15\%$ through the supplied DC power cable.

⚠ WARNING! NEVER reverse the DC power cable polarity.

[ANT]

Connect to an antenna for the HF, 50 MHz, and 70 MHz bands.

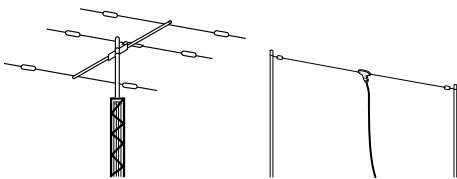

- Input/Output impedance: 50 Ω (unbalanced)
- Connector type: SO-239

[RX-ANT IN]/[RX-ANT OUT]

Connect to a receive antenna to [RX-ANT IN], and a receiver to [RX-ANT OUT].

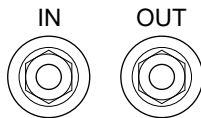

- Input/Output impedance: 50 Ω (unbalanced)
- Connector type: SMA

When [RX-ANT] is turned ON on the FUNCTION screen 2, a signal received from the antenna connector is output to [RX-ANT OUT], and [RX-ANT IN] is connected to the receiver. (p. 28) You can also connect an external preamp or filter to return the received signal to [RX-ANT IN], as shown below.

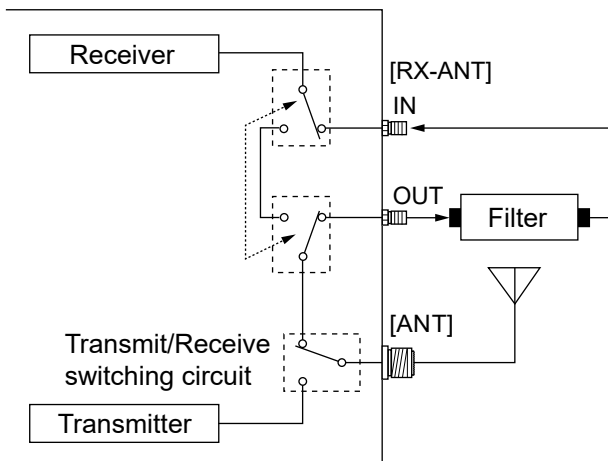

[HDMI]

- Connect to an external display monitor to mirror the touch screen.
- Connect to an external speaker.

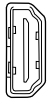

① You can change the display resolution in the following item.

MENU » SET > Display > External Display > External Display Resolution

① To output the audio from the external display or speaker, set "Audio Output" to "ON."
When the item is set to "ON" and an external display or speaker is connected, the internal speaker is automatically muted.

MENU » SET > Display > External Display > Audio Output

① Icom does not guarantee:

- The operation of all external displays or speakers.
- The connection with user supplied HDMI conversion adapters, HDMI compatible recorders, and so on.

[LAN]

- Time synchronization by an NTP server.
- Outputting the demodulated AF signal or 12 kHz IF signal.
- Remotely controlling using the optional RS-BA1 software.

① You can select the output signal from the AF and IF signals.

MENU » SET > Connectors > LAN AF/IF Output

About the LED indication

① LINK/ACT

- Lights green when a cable is connected.
- Does not light when a cable is not connected.
- Blinks green while communicating.

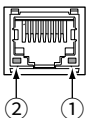

② Speed

- Lights green while communicating in 100BASE-TX.
- Does not light while communicating in 10BASE-T, or when a cable is not connected.

[EXT-SP]

Connect to an external speaker. (3.5 mm, 1/8 inch (d))

EXT-SP

- Output impedance: 4 ~ 8 Ω
- Output level: More than 2.5 W (8 Ω load, 10% distortion)



[REMOTE]

Connect to a PC, a linear amplifier, or other transceiver for remote control. (3.5 mm, 1/8 inch (d))

REMOTE

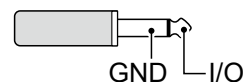

[USB]

Use the USB Type-C port as:

USB Audio Input

- Inputting an AF modulation signal.

**USB Audio Output**

- Outputting a demodulated AF signal or 12 kHz IF signal.

① You can change the signal output type and output level.

MENU » SET > Connectors > **USB AF/IF Output**

USB Serial Port

- Outputting decoded RTTY data.
- Interface for remote control using CI-V commands.
- Remotely controlling using the optional RS-BA1 software.

① You can communicate regardless of the PC software's baud rate setting.

① You can download the USB driver and installation guide from the Icom website.

<https://www.icomjapan.com/support/>

[KEY]

Connect to a Paddle key or Straight key.

① You can select the key type.

MENU » SET > CW-KEY Set > **Key Type**

KEY



- Paddle key

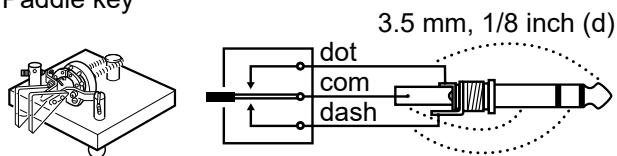

- Straight key

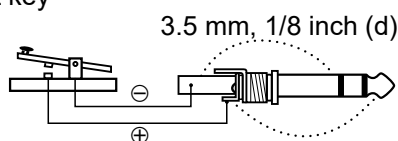
**[PHONES]**

Connect to standard stereo headphones: PHONES

- Output impedance: 8 ~ 16 Ω
- Output level: More than 5 mW into an 8 Ω load.



Front panel view

① While headphones are connected, the internal speaker, [EXT-SP] jack, and [HDMI] port are deactivated.

① If you use headphones with high impedance, the output audio may be too loud.

3.5 mm, 1/8 inch (d)

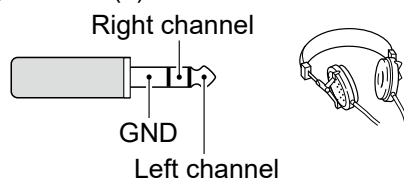
**[TUNER]**

- Connect the control cable of the optional AH-730 AUTOMATIC ANTENNA TUNER (p. 20)

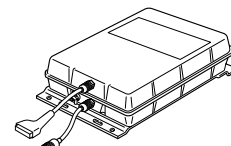
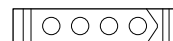

AH-730 (option)

- Connect the optional OPC-2321 CONTROL CABLE of the optional AH-740 AUTOMATIC TUNING ANTENNA.

① See the Advanced manual for details.

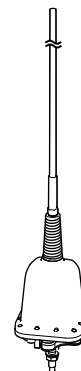

AH-740 (option)

[SEND]

Used to control external equipment, such as SEND a non-Icom linear amplifier.

The terminal goes low when the transceiver transmits.

① When connecting a non-Icom linear amplifier to the transceiver, select "ON" in the following item.

MENU » SET > Connectors > **SEND Relay Output**

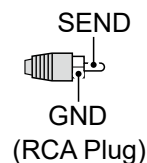
**[ALC]**

Connect to an ALC voltage source when operating with a non-Icom linear amplifier.

- ALC voltage: -6 ~ 0 V

ALC

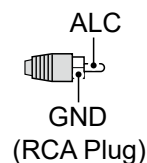

INDEX

1/4 Tuning function	24
1 Hz step Fine Tuning function	24

A

ACC	
AF/IF Output	57
Connecting	21
Connector	74
AGC function	30
AH-730	
Connecting	20
Using	47
AH-740	47
ALC	
Connecting	21
Connector	77
Antenna	76
Antenna tuner	
Connecting	20
Emergency mode (Tuner)	48
External	47
Internal	46
Specifications	71
Attenuator	29
Audio scope	43
Auto Tuning Step function	24

B

Band Stacking Register	23
Break-in function	
Full Break-in	39
Semi Break-in	38

C

Cleaning	65
Clock	
Current time	64
Date	64
UTC offset	64
Connectors (Set mode)	56
CW	
Audio Peak Filter (APF)	39
Auto Tuning function	39
Key speed	38
Pitch control	38
Side tone	39
CW-KEY Set (Set mode)	50

D

Data mode	23
DC 13.8 V	
Connecting	20
Connector	76
Desktop stand	19
Digital Twin PBT	32
Display (Set mode)	60

E

Electronic Keyer function	40
Entering and editing	6
External keypad	75
EXT-SP (Connector)	76

F

Filter	
IF filter	33
Notch Filter	35
Transmit filter width	35
Frequency	
Directly entering	25
Using the Main Dial	24
FUNCTION screen	17
Function (Set mode)	51
Fuse	65

G

General (Specifications)	70
Grounding	19

H

HDMI	
Connector	76
External Display	60
Heat dissipation	19

I

IC-PW2	
Connecting	21
Using	47
IP Plus function	37

K

KEY	
Connector	77
Key Type	51
Key assignment	
Front panel	55
Microphone	55, 56
Keyboard	
Keyboard types	6
Usable characters	7

L

LAN	
Connector	76
Output Select	57
Linear amplifier	
Connecting	21
Connector	76
Using	47
Location	19

M		S	
Main Dial		SD card.....	44
Dial Lock function.....	27	SD Card (Set mode).....	62
Friction adjuster.....	12	SEND	
MB-118.....	73	Connecting.....	21
MB-123.....	73	Connector.....	77
Memory mode.....	22	S-meter squelch.....	26
MENU screen.....	17	Spectrum scope	
MENU SET screen.....	17	Center mode.....	42
Meter display.....	28	Fixed mode.....	42
MIC		Marker.....	42
Connector.....	75	Mini scope screen.....	43
PTT Port Function.....	58	Scroll mode.....	42
Microphone gain.....	27	Speech Compressor.....	31
Monitor function.....	37	Split frequency operation.....	36
Multi-function dial.....	18	Split Lock function.....	37, 52
Multi-function menus.....	18	SQL level.....	26
Multi-function meter.....	28	Squelch.....	26
N		T	
Network (Set mode).....	59	Time Set (Set mode).....	62
Noise Blanker.....	34	Tone Control/TBW (Set mode).....	50
Noise Reduction.....	34	Touch screen display.....	15
Noise squelch.....	26	Transmit output power.....	27
O		Transmitter (Specifications).....	70
OPC-599		Troubleshooting.....	67
Connecting.....	21	TUNER	
Pin assignments.....	75	Connecting.....	20
Operating band.....	23	Connector.....	77
Operating mode.....	23	Tuning Step.....	24
Options.....	72	U	
Oscilloscope.....	43	USB (Connector).....	77
Others (Set mode).....	63	V	
P		VFO mode.....	22
PHONES (Connector).....	77	Volume level.....	22
Q			
QUICK MENU screen.....	17		
Quick Split function.....	36, 52		
Quick Tuning Step function.....	24		
R			
Receiver (Specifications).....	71		
Resetting.....	66		
RF gain.....	26		
RIT function.....	29		
RX-ANT			
Connector.....	76		
ON/OFF.....	28		

ABOUT THE LICENSES

Information on the open source software being used by this product.

COPYRIGHT NOTICE, DISCLAIMER, and LICENSE:

If you modify libpng you may insert additional notices immediately following this sentence.

This code is released under the libpng license.

libpng versions 1.2.6, August 15, 2004, through 1.6.12, June 12, 2014, are Copyright (c) 2004, 2006-2014 Glenn Randers-Pehrson, and are distributed according to the same disclaimer and license as libpng-1.2.5 with the following individual added to the list of Contributing Authors:

Cosmin Truta
libpng versions 1.0.7, July 1, 2000, through 1.2.5, October 3, 2002, are Copyright (c) 2000-2002 Glenn Randers-Pehrson, and are distributed according to the same disclaimer and license as libpng-1.0.6 with the following individuals added to the list of Contributing Authors:

Simon-Pierre Cadieux
Eric S. Raymond
Gilles Vollant

and with the following additions to the disclaimer:

There is no warranty against interference with your enjoyment of the library or against infringement. There is no warranty that our efforts or the library will fulfill any of your particular purposes or needs. This library is provided with all faults, and the entire risk of satisfactory quality, performance, accuracy, and effort is with the user.

libpng versions 0.97, January 1998, through 1.0.6, March 20, 2000, are Copyright (c) 1998, 1999, 2000 Glenn Randers-Pehrson, and are distributed according to the same disclaimer and license as libpng-0.96, with the following individuals added to the list of Contributing Authors:

Tom Lane
Glenn Randers-Pehrson
Willem van Schaik

libpng versions 0.89, June 1996, through 0.96, May 1997, are Copyright (c) 1996, 1997 Andreas Dilger Distributed according to the same disclaimer and license as libpng-0.88, with the following individuals added to the list of Contributing Authors:

John Bowler
Kevin Bracey
Sam Bushell
Magnus Holmgren
Greg Roelofs
Tom Tanner

libpng versions 0.5, May 1995, through 0.88, January 1996, are Copyright (c) 1995, 1996 Guy Eric Schalnat, Group 42, Inc. For the purposes of this copyright and license, "Contributing Authors" is defined as the following set of individuals:

Andreas Dilger
Dave Martindale
Guy Eric Schalnat
Paul Schmidt
Tim Wegner

The PNG Reference Library is supplied "AS IS". The Contributing Authors and Group 42, Inc. disclaim all warranties, expressed or implied, including, without limitation, the warranties of merchantability and of fitness for any purpose. The Contributing Authors and Group 42, Inc. assume no liability for direct, indirect, incidental, special, exemplary, or consequential damages, which may result from the use of the PNG Reference Library, even if advised of the possibility of such damage.

Permission is hereby granted to use, copy, modify, and distribute this source code, or portions hereof, for any purpose, without fee, subject to the following restrictions:

1. The origin of this source code must not be misrepresented.
2. Altered versions must be plainly marked as such and must not be misrepresented as being the original source.
3. This Copyright notice may not be removed or altered from any source or altered source distribution.

The Contributing Authors and Group 42, Inc. specifically permit, without fee, and encourage the use of this source code as a component to supporting the PNG file format in commercial products. If you use this source code in a product, acknowledgment is not required but would be appreciated.

A "png_get_copyright" function is available, for convenient use in "about" boxes and the like:

```
printf("%s", png_get_copyright(NULL));
```

Also, the PNG logo (in PNG format, of course) is supplied in the files "pngbar.png" and "pngbar.jpg (88x31)" and "pngnow.png" (98x31).

Libpng is OSI Certified Open Source Software. OSI Certified is a certification mark of the Open Source Initiative. The contributing authors would like to thank all those who helped with testing, bug fixes, and patience. This wouldn't have been possible without all of you. Thanks to Frank J. T. Wojcik for helping with the documentation.

License for CMSIS-RTOS RTX Implementation

Copyright (c) 1999-2009 KEIL, 2009-2013 ARM Germany GmbH All rights reserved. Redistribution and use in source and binary forms, with or without modification, are permitted provided that the following conditions are met:

- Redistributions of source code must retain the above copyright notice, this list of conditions and the following disclaimer.
- Redistributions in binary form must reproduce the above copyright notice, this list of conditions and the following disclaimer in the documentation and/or other materials provided with the distribution.
- Neither the name of ARM nor the names of its contributors may be used to endorse or promote products derived from this software without specific prior written permission.

THIS SOFTWARE IS PROVIDED BY THE COPYRIGHT HOLDERS AND CONTRIBUTORS "AS IS" AND ANY EXPRESS OR IMPLIED WARRANTIES, INCLUDING, BUT NOT LIMITED TO, THE IMPLIED WARRANTIES OF MERCHANTABILITY AND FITNESS FOR A PARTICULAR PURPOSE ARE DISCLAIMED. IN NO EVENT SHALL COPYRIGHT HOLDERS AND CONTRIBUTORS BE LIABLE FOR ANY DIRECT, INDIRECT, INCIDENTAL, SPECIAL, EXEMPLARY, OR CONSEQUENTIAL DAMAGES (INCLUDING, BUT NOT LIMITED TO, PROCUREMENT OF SUBSTITUTE GOODS OR SERVICES; LOSS OF USE, DATA, OR PROFITS; OR BUSINESS INTERRUPTION) HOWEVER CAUSED AND ON ANY THEORY OF LIABILITY, WHETHER IN CONTRACT, STRICT LIABILITY, OR TORT (INCLUDING NEGLIGENCE OR OTHERWISE) ARISING IN ANY WAY OUT OF THE USE OF THIS SOFTWARE, EVEN IF ADVISED OF THE POSSIBILITY OF SUCH DAMAGE.

ZLIB DATA COMPRESSION LIBRARY

zlib 1.2.8 is a general purpose data compression library. All the code is thread safe. The data format used by the zlib library is described by RFCs (Request for Comments) 1950 to 1952 in the files <http://tools.ietf.org/html/rfc1950> (zlib format), [rfc1951](http://tools.ietf.org/html/rfc1951) (deflate format) and [rfc1952](http://tools.ietf.org/html/rfc1952) (gzip format).

All functions of the compression library are documented in the file zlib.h (volunteer to write man pages welcome, contact zlib@gzip.org). A usage example of the library is given in the file test/example.c which also tests that the library is working correctly. Another example is given in the file test/minigzip.c. The compression library itself is composed of all source files in the root directory.

To compile all files and run the test program, follow the instructions given at the top of Makefile.in. In short ". /configure; make test", and if that goes well, "make install" should work for most flavors of Unix. For Windows, use one of the special makefiles in win32/contrib/vstudio/. For VMS, use make_vms.com.

Questions about zlib should be sent to zlib@gzip.org, or to Gilles Vollant info@winimage.com for the Windows DLL version. The zlib home page is <http://zlib.net/>. Before reporting a problem, please check this site to verify that you have the latest version of zlib; otherwise get the latest version and check whether the problem still exists or not.

PLEASE read the zlib FAQ http://zlib.net/zlib_faq.html before asking for help.

Mark Nelson markn@ieee.org wrote an article about zlib for the Jan. 1997 issue of Dr. Dobbs's Journal; a copy of the article is available at <http://marknelson.us/1997/01/01/zlib-engine/>.

The changes made in version 1.2.8 are documented in the file ChangeLog.

Unsupported third party contributions are provided in directory contrib/. zlib is available in Java using the java.util.zip package, documented at <http://java.sun.com/developer/technicalArticles/Programming/compression/>.

A Perl interface to zlib written by Paul Marquess pmqs@cpan.org is available at CPAN (Comprehensive Perl Archive Network) sites, including <http://search.cpan.org/~pmqs/IO-Compress-Zlib/>.

A Python interface to zlib written by A.M.Kuchling amk@amk.ca is available in Python 1.5 and later versions, see <http://docs.python.org/library/zlib.html>.

zlib is built into tcl: <http://wiki.tcl.tk/4610>.

An experimental package to read and write files in .zip format, written on top of zlib by Gilles Vollant info@winimage.com, is available in the contrib/minizip directory of zlib.

Notes for some targets:

- For Windows DLL versions, please see win32/DLL_FAQ.txt
- For 64-bit Irix, deflate.c must be compiled without any optimization. With -O, one libpng test fails. The test works in 32 bit mode (with the -n32 compiler flag). The compiler bug has been reported to SGI.
- zlib doesn't work with gcc 2.6.3 on a DEC 3000/300LX under OSF/1 2.1 it works when compiled with cc.
- On Digital Unix 4.0D (formerly OSF/1) on AlphaServer, the cc option -std1 is necessary to get gzprintf working correctly. This is done by configure.
- zlib doesn't work on HP-UX 9.05 with some versions of /bin/cc. It works with other compilers. Use "make test" to check your compiler.
- gzopen is not supported on RISCOS or

BEOS.

- For PalmOs, see <http://palmzlib.sourceforge.net/>

Acknowledgments:

The deflate format used by zlib was defined by Phil Katz. The deflate and zlib specifications were written by L. Peter Deutsch. Thanks to all the people who reported problems and suggested various improvements in zlib; they are too numerous to cite here.

Copyright notice:

(C) 1995-2013 Jean-loup Gailly and Mark Adler

This software is provided 'as-is', without any express or implied warranty. In no event will the authors be held liable for any damages arising from the use of this software.

Permission is granted to anyone to use this software for any purpose, including commercial applications, and to alter it and redistribute it freely, subject to the following restrictions:

1. The origin of this software must not be misrepresented; you must not claim that you wrote the original software. If you use this software in a product, an acknowledgment in the product documentation would be appreciated but is not required.
2. Altered source versions must be plainly marked as such, and must not be misrepresented as being the original software.
3. This notice may not be removed or altered from any source distribution.

Jean-loup Gailly Mark Adler
jloup@gzip.org madler@alumni.caltech.edu
If you use the zlib library in a product, we would appreciate *not* receiving lengthy legal documents to sign. The sources are provided for free but without warranty of any kind. The library has been entirely written by Jean-loup Gailly and Mark Adler; it does not include third-party code.

If you redistribute modified sources, we would appreciate that you include in the file ChangeLog history information documenting your changes. Please read the FAQ for more information on the distribution of modified source versions.

mbed TLS

Apache License
Version 2.0, January 2004
<http://www.apache.org/licenses/>
TERMS AND CONDITIONS FOR USE,
REPRODUCTION, AND DISTRIBUTION

1. Definitions.

"License" shall mean the terms and conditions for use, reproduction, and distribution as defined by Sections 1 through 9 of this document.

"Licensor" shall mean the copyright owner or entity authorized by the copyright owner that is granting the License.

"Legal Entity" shall mean the union of the acting entity and all other entities that control, are controlled by, or are under common control with that entity. For the purposes of this definition, "control" means (i) the power, direct or indirect, to cause the direction or management of such entity, whether by contract or otherwise, or (ii) ownership of fifty percent (50%) or more of the outstanding shares, or (iii) beneficial ownership of such entity.

"You" (or "Your") shall mean an individual or Legal Entity exercising permissions granted by this License.

"Source" form shall mean the preferred form for making modifications, including but not limited to software source code, documentation source, and configuration files.

"Object" form shall mean any form resulting from mechanical transformation or translation of a Source form, including but not limited to compiled object code, generated documentation, and conversions to other media types.

"Work" shall mean the work of authorship, whether in Source or Object form, made available under the License, as indicated by a copyright notice that is included in or attached to the work (an example is provided in the Appendix below).

"Derivative Works" shall mean any work, whether in Source or Object form, that is based on (or derived from) the Work and for which the editorial revisions, annotations, elaborations, or other modifications represent, as a whole, an original work of authorship. For the purposes of this License, Derivative Works shall not include works that remain separable from, or merely link (or bind by name) to the interfaces of, the Work and Derivative Works thereof.

"Contribution" shall mean any work of authorship, including the original version of the Work and any modifications or additions to that Work or Derivative Works thereof, that is intentionally submitted to Licensor for inclusion in the Work by the copyright owner or by an individual or Legal Entity authorized to submit on behalf of the copyright owner. For the purposes of this definition, "submitted" means any form of electronic, verbal, or written communication sent to the Licensor or its representatives, including but not limited to communication on electronic mailing lists, source code control systems, and issue tracking systems that are managed by, or on behalf of, the Licensor for the purpose of discussing and improving the Work, but excluding communication that is conspicuously marked or otherwise designated in writing by the copyright

owner as "Not a Contribution."

"Contributor" shall mean Licensor and any individual or Legal Entity on behalf of whom a Contribution has been received by Licensor and subsequently incorporated within the Work.

2. Grant of Copyright License. Subject to the terms and conditions of this License, each Contributor hereby grants to You a perpetual, worldwide, non-exclusive, no-charge, royalty-free, irrevocable copyright license to reproduce, prepare Derivative Works of, publicly display, publicly perform, sublicense, and distribute the Work and such Derivative Works in Source or Object form.

3. Grant of Patent License. Subject to the terms and conditions of this License, each Contributor hereby grants to You a perpetual, worldwide, non-exclusive, no-charge, royalty-free, irrevocable (except as stated in this section) patent license to make, have made, use, offer to sell, sell, import, and otherwise transfer the Work, where such license applies only to those patent claims licensable by such Contributor that are necessarily infringed by their Contribution(s) alone or by combination of their Contribution(s) with the Work to which such Contribution(s) was submitted. If You institute patent litigation against any entity (including a cross-claim or counterclaim in a lawsuit) alleging that the Work or a Contribution incorporated within the Work constitutes direct or contributory patent infringement, then any patent licenses granted to You under this License for that Work shall terminate as of the date such litigation is filed.

4. Redistribution. You may reproduce and distribute copies of the Work or Derivative Works thereof in any medium, with or without modifications, and in Source or Object form, provided that You meet the following conditions:

- You must give any other recipients of the Work or Derivative Works a copy of this License; and
- You must cause any modified files to carry prominent notices stating that You changed the files; and
- You must retain, in the Source form of any Derivative Works that You distribute, all copyright, patent, trademark, and attribution notices from the Source form of the Work, excluding those notices that do not pertain to any part of the Derivative Works; and
- If the Work includes a "NOTICE" text file as part of its distribution, then any Derivative Works that You distribute must include a readable copy of the attribution notices contained within such NOTICE file, excluding those notices that do not pertain to any part of the Derivative Works, in at least one of the following places: within the Source form or documentation, if provided along with the Derivative Works; or, within a display generated by the Derivative Works, if and wherever such third-party notices normally appear. The contents of the NOTICE file are for informational purposes only and do not modify the License. You may add Your own attribution notices within Derivative Works that You distribute, alongside or as an addendum to the NOTICE

text from the Work, provided that such additional attribution notices cannot be construed as modifying the License.

You may add Your own copyright statement to Your modifications and may provide additional or different license terms and conditions for use, reproduction, or distribution of Your modifications, or for any such Derivative Works as a whole, provided Your use, reproduction, and distribution of the Work otherwise complies with the conditions stated in this License.

5. Submission of Contributions. Unless You explicitly state otherwise, any Contribution intentionally submitted for inclusion in the Work by You to the Licensor shall be under the terms and conditions of this License, without any additional terms or conditions. Notwithstanding the above, nothing herein shall supersede or modify the terms of any separate license agreement you may have executed with Licensor regarding such Contributions.

6. Trademarks. This License does not grant permission to use the trade names, trademarks, service marks, or product names of the Licensor, or as required for reasonable and customary use in describing the origin of the Work and reproducing the content of the NOTICE file.

7. Disclaimer of Warranty. Unless required by applicable law or agreed to in writing, Licensor provides the Work (and each Contributor provides its Contributions) on an "AS IS" BASIS, WITHOUT WARRANTIES OR CONDITIONS OF ANY KIND, either express or implied, including, without limitation, any warranties or conditions of TITLE, NON-INFRINGEMENT, MERCHANTABILITY, or FITNESS FOR A PARTICULAR PURPOSE. You are solely responsible for determining the appropriateness of using or redistributing the Work and assume any risks associated with Your exercise of permissions under this License.

8. Limitation of Liability. In no event and under no legal theory, whether in tort (including negligence), contract, or otherwise, unless required by applicable law (such as deliberate and grossly negligent acts) or agreed to in writing, shall any Contributor be liable to You for damages, including any direct, indirect, special, incidental, or consequential damages of any character arising as a result of this License or out of the use or inability to use the Work (including but not limited to damages for loss of goodwill, work stoppage, computer failure or malfunction, or any and all other commercial damages or losses), even if such Contributor has been advised of the possibility of such damages.

9. Accepting Warranty or Additional Liability. While redistributing the Work or Derivative Works thereof, You may choose to offer, and charge a fee for, acceptance of support, warranty, indemnity, or other liability obligations and/or rights consistent with this License. However, in accepting such obligations, You may act only on Your own behalf and on Your sole responsibility, not on behalf of any other Contributor, and only if You agree to indemnify, defend, and hold each Contributor harmless for any liability incurred by, or claims asserted

against, such Contributor by reason of your accepting any such warranty or additional liability.

END OF TERMS AND CONDITIONS

APPENDIX: How to apply the Apache License to your work.

To apply the Apache License to your work, attach the following boilerplate notice, with the fields enclosed by brackets "[]" replaced with your own identifying information. (Don't include the brackets!) The text should be enclosed in the appropriate comment syntax for the file format. We also recommend that a file or class name and description of purpose be included on the same "printed page" as the copyright notice for easier identification within third-party archives.

Copyright 2016, Arthur Teplitzki 2013, Edmodo, Inc.

Licensed under the Apache License, Version 2.0 (the "License"); you may not use this file except in compliance with the License. You may obtain a copy of the License at

<http://www.apache.org/licenses/LICENSE-2.0>

Unless required by applicable law or agreed to in writing, software distributed under the License is distributed on an "AS IS" BASIS, WITHOUT WARRANTIES OR CONDITIONS OF ANY KIND, either express or implied. See the License for the specific language governing permissions and limitations under the License.

MEMO

Lined area for writing the memo content, featuring horizontal lines and dotted lines for structured input.

Dotted lines for writing.

