

RIGblaster plus

rig to sound card interface

OWNERS MANUAL

4TH EDITION

IF YOU CAN'T FIND IT HERE GO TO OUR SUPPORT PAGE:
<http://www.westmountainradio.com/supportplu.htm>

West Mountain Radio

<http://www.westmountainradio.com>

18 Sheehan Avenue, Norwalk, CT 06854 tel 203 853 8080 fax 203 299 0232

RIGblaster WARRANTY

The RIGblaster is warranted against failure due to defects in workmanship or materials for one year after the date of purchase from West Mountain Radio. Warranty does not cover damage caused by abuse, accident, misuse, improper or abnormal usage, failure to follow instructions, improper installation, alteration, lightning, or other incidence of excessive voltage or current. If failure occurs within this period, return the RIGblaster or accessory to West Mountain Radio at your shipping expense. The device or accessory will be repaired or replaced, at our option, without charge, and returned to you at our shipping expense. Repaired or replaced items are warranted for the remainder of the original warranty period. You will be charged for repair or replacement of the RIGblaster or accessory made after the expiration of the warranty period.

The Compact Disc of Radio Amateur Software Collection is excluded from any and all warranties by West Mountain Radio. Note that the programs have been provided as shareware or freeware by the software authors to the amateur radio community for their use and enjoyment. The CD is to be used at your own risk.

West Mountain Radio shall have no liability or responsibility to customer or any other person or entity with respect to any liability, loss, or damage caused directly or indirectly by use or performance of the products or arising out of any breach of this warranty, including, but not limited to, any damages resulting from inconvenience, loss of time, data, property, revenue, or profit, or any indirect, special incidental, or consequential damages, even if West Mountain Radio has been advised of such damages.

Except as provided herein, West Mountain Radio makes no express warranties and any implied warranties, including fitness for a particular purpose, are limited in duration to the stated duration provided herein.

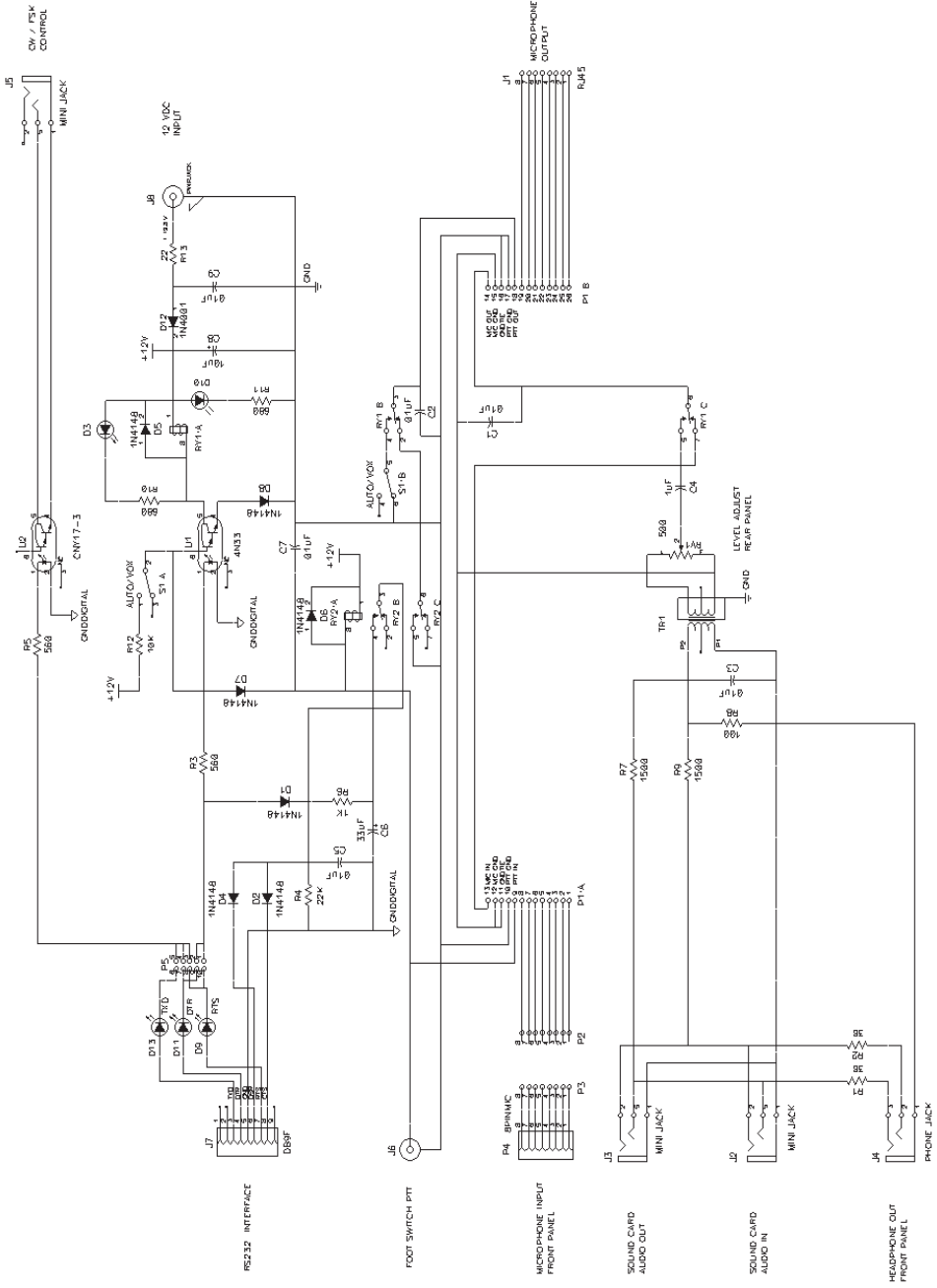

RJ45 MODULAR TEL. STYLE JUMPER DIAGRAMS CONTINUED

Kenwood Modular RJ45 Most but not all FM rigs.

Pin #	Connection
1	Direct blue shunt jumper
2	Direct blue shunt jumper
3	PTT common (Ground)
4	Push to talk, PTT, CRISSCROSSED
5	MIC common (Ground)
6	Microphone audio, CRISSCROSSED
7	Direct blue shunt jumper
8	Direct blue shunt jumper

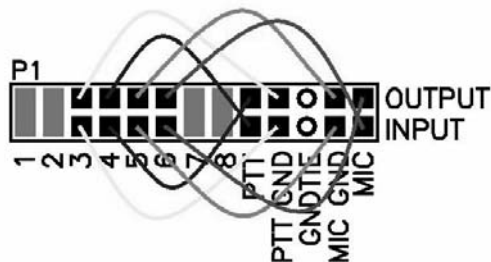

Yaesu Modular RJ45 Most but not all FM rigs.

Pin #	Connection
1	Direct blue shunt jumper
2	PTT common (Ground)
3	Push to talk, PTT, CRISSCROSSED
4	Microphone audio, CRISSCROSSED
5	MIC common (Ground)
6	Direct blue shunt jumper
7	Direct blue shunt jumper
8	Direct blue shunt jumper

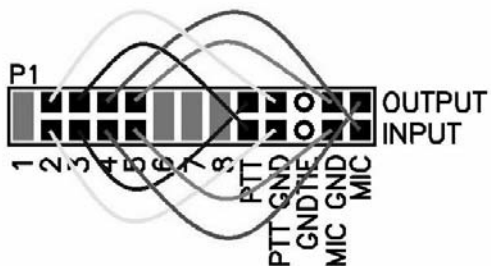

SERIAL KEYING JUMPER DIAGRAM EXAMPLES

Here are some examples of serial control jumper options. There are other possibilities, but the default should be fine for the casual operator. Depending on your choice of software you may need one of these examples. The idea is to match the PTT and various keying options of the software you intend to use. Even though we tried to make it as flexible as possible, you may not be able to configure it to work with two programs that require different configurations.

Like the mic. jumper block the black rectangles indicate blue two pin jumpers. You may store your unused jumpers by putting only one side of the jumper on only one pin.

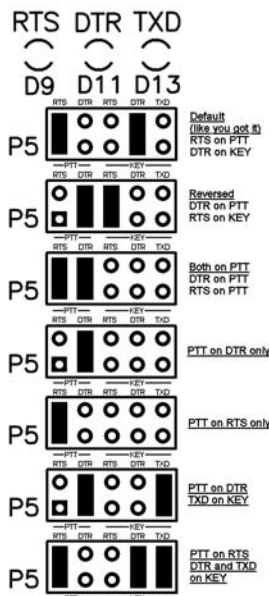

RIGblaster rig to sound card interface

Thank you for buying the RIGblaster Plus. We are sure you will find it provides many hours of amateur radio enjoyment. Please read and follow these instructions carefully for a fast and easy installation.

INSTALLATION INSTRUCTIONS (PROCEED IN ORDER, STEP BY STEP!)

1. INSTALL SOFTWARE AND START RECEIVING: You do not need the RIGblaster to receive so leave it in the box. Use our CD or check for newer versions of the software on the Internet. Even if you have a preference for which program or mode to try first, we recommend that you start with a simple PSK31 program. WinPSK is an easy one that ONLY requires entering your callsign and serial port info.

Connect the speaker output of your radio to the line input (mic. on a laptop) on your computer. Other connections may be used but test initially with this simple hookup. Radios have several audio outputs and computers have line and mic. inputs; consider signal levels, grounding and convenience for your best connection. If you use the line level, data or phone patch output of your radio you may have to use the mic. input on the computer. Make sure that your computer is plugged into the same grounded outlet as your radio. Do not attempt to run your computer on one circuit of your house and your radio on another, this may cause audio problems, not to mention risky station safety grounding.

Read your software documentation and you should be up and receiving in minutes. Most start-up problems are software related!

After you have your software receiving properly, check that transmit audio is generated by the software. You should be able to hear transmit sound when you put software in to transmit. This is an important test of your sound card's proper operation, no transmit sound no transmit! Do not proceed further if you have a transmit audio problem; fix it!

If you have any problem with software you are trying, simply try another program, if another program works you have found the problem. If several programs do not work check your sound card set up (sound card control panel or driver installation). Sound card problems are supported by the computer hardware manufacturer. If any of the 30 or more virtual controls for your sound card do not function you may need to re-install your sound card with the correct drivers provided by the sound card manufacturer. Follow the hardware manufacturer's instructions.

Continue to the next step only after you have confirmed that you can receive and have transmit sound. See the appropriate software documentation if you have problems.

2. CHECK AND SET THE RIGblaster JUMPERS: Jumpers are not installed for operation as shipped out of the box; they are packed separately. To install the jumpers see the section starting on page 8 in this manual.

After you have installed the jumpers, connect only the RIGblaster mic. cable, power supply, and your mic. The RIGblaster power light should be on. Confirm that EVERYTHING

on your mic. works perfectly, including on-the-air audio reports. If your mic. works perfectly you probably have the jumpers installed correctly. If you have a problem, make sure that you used the jumper diagram that matches your mic. not radio. After market mics., especially Yaesu, may not have exactly the same wiring as the original mic.

If, and only if, your mic. works perfectly, continue to the next step.

3. CONNECT A SERIAL CABLE: (SKIP THIS STEP FOR VOX OPERATION) Use the supplied serial cable for the connection between a serial port on your computer and the RIGblaster.

Boot up your computer with the RIGblaster in the AUTO mode. Watch the DIGITAL light on the RIGblaster and the PTT transmit indicator on your radio. During the boot up sequence you should see the lights turn on at least once. After boot up is completed they should be off. This test confirms that the cable, the computer, and the RIGblaster are working properly together. Check our support page if you have Windows/ME.

If this check is OK it confirms that all of your hardware is working! If and only if this test is correct continue to the next step.

4. AUTO SERIAL CONTROL SET UP AND TEST: (SKIP THIS STEP FOR VOX OPERATION) Start the program that you have installed and have working. Go to that software's configuration menu (consult the software docs or help file) and setup the software to use the COM port that your RIGblaster's serial cable is plugged in to. You may also need to set the software to use the serial RTS pin. The RIGblaster plus is set by default to use RTS for PTT. If you wish, you may re-configure PTT control to use DTR and/or RTS; see the serial jumper diagram on page 10 in this manual.

Set the RIGblaster to the AUTO mode. Put your software in transmit (TX) and check that the DIGITAL light comes on and that your radio automatically switches to transmit (you may not see any RF output until you complete the next step). Make sure that your radio is set to the mode that is appropriate for the software you are using, usually USB.

Continue to the next step only if you have serial control working.

5. CONNECT TRANSMIT AUDIO: Connect a STEREO audio cable from your sound card line output (laptop headphone output) to the RIGblaster's audio input. You must unplug your desktop computer's speakers to connect the RIGblaster. You should plug them back in to the RIGblaster's audio output so that they operate as they did before.

6. SET THE AUDIO LEVEL TO YOUR RIG: For SSB radio's use your normal mic. gain setting, your speech compressor off and the transmitter's RF drive (power control) turned all the way up.

Confirm that the RIGblaster's audio level control is turned all the way up (full clockwise as viewed from the back) (DO NOT USE FORCE! You may damage the control).

Open your Windows sound control panel (double click the yellow speaker icon) and un-mute or select the "wave" output and the left hand "Volume Control" output. Set the virtual "Volume" and "Wave" sliders to one notch down from the top. Also set the virtual balance sliders to the center.

If your computer speakers are hooked up and they have a volume control knob, turn that knob most of the way, but not all of the way, down. If they don't have a volume knob they may be

8 PIN SCREW ON MICROPHONE JUMPER DIAGRAMS CONTINUED

Yaesu mics. with common PTT & audio grounds 8 pin screw on Older hand mics, desk mics and Heil mics.

Pin #	Connection
1	Direct blue shunt jumper
2	Direct blue shunt jumper
3	Direct blue shunt jumper
4	Direct blue shunt jumper
5	Direct blue shunt jumper
6	Push to talk, PTT
7	PTT and Mic. common
8	Microphone audio

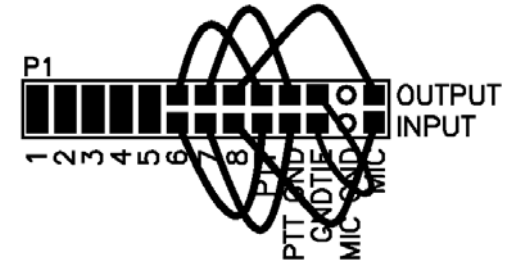

Yaesu mics. with isolated grounds and JRC JST245 8 pin screw on Only original mics. that came with FT1000MP/MK V, FT920, FT847 etc.

Pin #	Connection
1	Direct blue shunt jumper
2	Direct blue shunt jumper
3	Direct blue shunt jumper
4	Direct blue shunt jumper
5	PTT common (Ground)
6	Push to talk, PTT
7	Mic. common (Ground)
8	Microphone audio

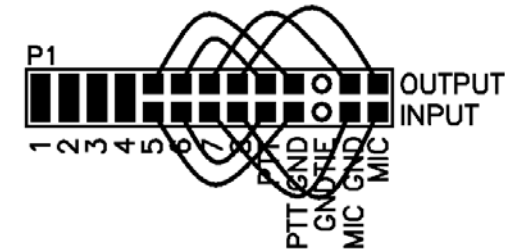

RJ45 MODULAR TEL. STYLE JUMPER DIAGRAMS

Plug your RJ45 mic. in to the back "mic out" jack of the RIGblaster. Using the supplied mic. cable, screw the 8 pin plug in to the front of the RIGblaster and plug the RJ45 end in to your radio's RJ45 mic. jack. Be sure to use the correct diagram for your radio, as follows, and observe that PTT & MIC are crisscrossed!

Icom Modular

IC706 (all versions), FM Icoms (V8000, IC2000H, IC207H do not work properly, see our support page).

Pin #	Connection
1	Direct blue shunt jumper
2	PTT common (Ground)
3	Microphone audio, CRISSCROSSED
4	MIC common (Ground)
5	Push to talk, PTT, CRISSCROSSED
6	Direct blue shunt jumper
7	Direct blue shunt jumper
8	Direct blue shunt jumper

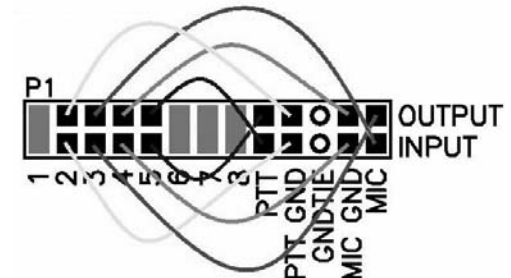

TROUBLESHOOTING

If you installed the RIGblaster following the steps in this manual you need not go back to a previous step. The problem is isolated to the step that you found the problem on. Most problems are software related and you need to consult your software's documentation.

If you would like further help, see our support page, for the latest help and suggestions: <http://www.westmountainradio.com/support.htm>

Please understand that the RIGblaster will not work if the software and computer do not work. Make sure that you have your software operating properly BEFORE connecting the RIGblaster and expecting it to work. You must read the documentation that comes with the software! Software instructions are not included in this manual. We did not write the software and we cannot support the software. The best thing to do if you have software problems is to try a different software package. If you have problems with two or more sound card programs you probably have a problem with your Windows sound card software installation, not your sound card hardware.

Enjoy operating and work lots of DX!
Dan Gravereaux, N1ZZ and Del Schier, K1UHF

8 PIN SCREW ON MICROPHONE JUMPER DIAGRAMS

Alinco, Kenwood, SGC, Elecraft 8 pin screw on

Pin #	Connection
1	Microphone audio
2	Push to talk, PTT
3	Direct blue shunt jumper
4	Direct blue shunt jumper
5	Direct blue shunt jumper
6	Direct blue shunt jumper
7	Mic. common (Ground)
8	PTT common (Ground)

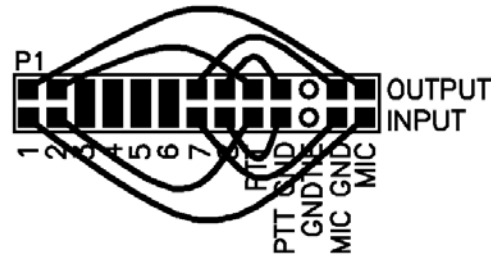

Icom 8 pin screw on

Pin #	Connection
1	Microphone audio
2	Direct blue shunt jumper
3	Direct blue shunt jumper
4	Direct blue shunt jumper
5	Push to talk, PTT
6	PTT common (Ground)
7	Mic. common (Ground)
8	Direct blue shunt jumper

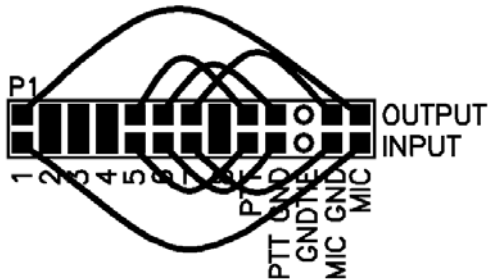

too loud and you will want to turn them off after you are sure that you can turn your sound card up high enough for them to be uncomfortably loud.

Check that the RIGblaster's VOX/AUTO switch is in AUTO. Set your software to transmit. Your RIGblaster's DIGITAL light should be green and your radio should indicate PTT activation, if it doesn't, recheck the serial port software setting for PTT control.

Your computer audio should be going to your rig and you should be transmitting. The audio level will probably be much too high. Turn down the wave output, master volume and RIGblaster audio level as necessary. You must achieve less than full RF output using your normal mic. setting, with the RF drive (power output) set to maximum.

With an FM rig you must set the audio level using a deviation meter or by comparing the level of your transmit audio to other stations by using a second receiver.

The sound card sliders should end up between 1/4 and 3/4 of the way up and the RIGblaster audio level control set between 1/8 and 7/8 up.

You should be able to achieve a happy balance between controls when they are all set properly. Remember that there are multiple audio controls which are cascaded and all interact. If any one of the controls is turned down too much it will give the appearance of NO TRANSMIT AUDIO.

If you didn't configure your software to control PTT as explained in steps 3 and 4 you will not be able to transmit, nothing will happen unless you set up VOX operation.

Hint: if you are using PSK software make sure that the transmit audio frequency is between 500 Hz and 2500 Hz otherwise you may be outside the limits of your radio's response and you may not be able to transmit properly.

Hint: check for the presence of transmit audio being fed in to the RIGblaster by listening to it at the audio output jack with headphones or computer speakers. Do not use low impedance un-amplified speakers, they will effectively short out your sound card output.

7. CW or FSK SETUP: The RIGblaster Plus has two optoisolator keying circuits, one for PTT control and the other for CW or FSK keying. Both CW and FSK may be done on any RIGblaster by injecting audio tones into the mic. jack using audio tones from a sound card. With the Plus model you also have the option of direct keyed CW and/or FSK. This will let you use special CW or FSK filters that only work in those modes. Not all CW or RTTY programs support direct keying via a serial port, check first before choosing your particular radio connections and serial setup.

For keyboard CW operation you would normally set the software so it controls PTT on RTS and CW keying on DTR. If it cannot be configured that way you may set it up any other way as long as you match the software setup and function to the serial control jumper block "P5" in the RIGblaster plus. The default out of the box setup of the serial control, is RTS on PTT and DTR on keying. Determine how your software may be configured and set the serial control jumpers if needed. See the serial keying jumper diagram on page 10 of this manual for serial jumper configuration diagrams.

Keyboard CW programs will co-exist with an external keyer wired in parallel with the RIGblaster's key output on a CW key jack. You will have a conflict if you try and use the built in keyer in your radio as the computers output is CW characters not paddle pushes.

Note, some CW software will allow you to connect your key paddle to your computer's parallel port allowing the software to function both as a keyboard keyer and a virtual keyer for your key, the RIGblaster doesn't support paddle connections.

For FSK keying you must connect the key out to the FSK keying terminals on the back of your radio. You may select both DTR for CW and TXD for FSK if your radio and software will accommodate that. Switching the mode on your radio should allow this simultaneous connection. You must check that the FSK connecting cable that you have supplied actually shifts the frequency of your radio when you short out the mini plug end. Do this by listening on another receiver and before you connect it to the RIGblaster's key out jack. When your RTTY software is setup and transmitting the RIGblaster's serial diagnostic lights should show that PTT is activated on RTS and TXD is flickering with the FSK keying.

8. WORK LOTS OF DX AND HAVE FUN: You are on the air! Try all the modes, not just one; experiment!

THIS COMPLETES THE BASIC INSTRUCTIONS OF THIS MANUAL.....

FOR MORE INFORMATION PLEASE READ FURTHER AND BE SURE TO VISIT OUR WEB SUPPORT PAGE: <http://www.westmountainradio.com/supportplu.htm>

MICROPHONE JUMPER INSTALLATION NOTES:

The jumper diagrams and charts in the back of this manual should be checked against the microphone wiring diagram in your radio's owners manual. Simply make sure that mic. audio, mic. ground, PTT, and ptt ground are on the same pins. It could be possible to damage your radio, but only by inadvertently shorting out any DC voltage that may be on the mic. jack. Pay particular attention to this before turning on your radio. Note that these diagrams are for the microphone as well as the radio. For example. the original hand mic. for an FT1000 MK V has isolated grounds but an FT1000 hand mic. has common grounds. Especially with Yaesu, jumper the RIGblaster to match the mic. as well as the radio.

The diagrams depict the actual appearance of the jumper block in the RIGblaster. The black rectangles represent the supplied blue two-pin jumpers. The black squares with the wires depict where the black and white wire jumpers go. The circles denote no jumpers or connections.

After completing and testing the jumper Installation you may put the cover on. Carefully align the rear panel over the connectors and the control, making sure that the side screw holes line up. Be careful not to put pressure on the switch levers with your thumbs when putting the cover on. Also be careful with the audio level adjustment pot on the back panel. The screws are sheet metal type and must be driven in firmly with a fresh, properly fitting, #2 phillips head tip. They will be tight at first and then will go easier; do not over tighten them when they reach bottom.

to the RIGblaster's input jack. The input also feeds the front panel headphone jack.

The Modular RJ45 jack connects the supplied RIGblaster mic. cable to feed the mic. jack on your radio.

The Front panel: The Plus has a standard 8-pin screw-on microphone jack. This is where you connect your mic.

There is a 1/4" convenience headphone jack provided to monitor the computer. You can hear your receive audio routed through the computer and you can also verify that the computer is producing transmit audio tones.

The VOX/AUTO switch selects the mode of transmit control and the audio switching. In the AUTO mode the mic. is always connected normally and the computer audio is selected automatically when the RIGblaster receives a PTT control command from the computer's serial port. In the VOX mode the computer audio is connected to trigger your rig's vox circuit. When the RIGblaster is in the VOX mode you cannot use VOX or your MOX button to activate your mic. You may always override at any time by pushing the PTT switch on your mic. or by using a switch connected to the RIGblaster's PTT in/out jack.

The DIGITAL LED shows green whenever the computer's audio is routed to your radio's mic. jack. It turns green in the auto mode with serial control activation, and it is on when the RIGblaster is in the VOX position. Whenever you push your mic. PTT button or close a switch connected to the foot switch jack, the LED will go out indicating that your mic is now connected.

The red power LED shows that 12 VDC is applied. The RIGblaster must be on in order for your mic. to work through the RIGblaster. The RIGblaster has no on/off switch because the power consumption is less than 0.2 watts in the AUTO position. It will run for about 60 years for the price of a power switch. The RIGblaster has extensive power surge protection and it is not necessary to ever turn it off.

We have included your choice of 3M Bumpon protective feet or double sided adhesive pads. You may want to stick the RIGblaster down, up or sideways with the pads or use the feet. The pads are nice as when you pull on a mic. with a coiled cord allowing it to stay in place.

Inside the RIGblaster: You will find two sets of jumper blocks, 3 LED's and of course, all of the components and circuitry.

The main jumper block "P1" is for connecting the microphone wiring to the appropriate radio and mic.

The extra jumper block "P5" allows you to select which serial line does what. You can have the DTR, RTS and TXD serial lines control your choice of PTT or keying, or disable them. This allows you to configure the RIGblaster to match various software.

There are also 3 diagnostic LED's that monitor the activity of the DTR, RTS and TXD lines. You can check that your computer and software are working by visually looking at these LED's.

Your final setting should produce approximately 50% RF power output from your radio. Warning: you should not exceed the AM, FM or RTTY power ratings of your radio. After all settings are completed, check to make sure your ALC meter is below limiting.

Note that if you run your sound card at maximum, and the RIGblaster level turned way down, you will have distortion from your sound card and a poor quality signal.

VOX OPERATION

To set up for vox operation, instead of automatic serial control, you need to understand the switching within the RIGblaster. In the AUTO mode your mic. is connected by default and it will work normally with your radio's vox. In the RIGblaster's VOX mode your mic. is disconnected and your computer audio is passed through to your radio allowing the computer audio to activate your rig's vox circuit. Your mic. will operate when you press it's PTT button automatically overriding the computer.

To set the rig's vox level controls you need to have set all the levels as described previously (using you MOX button to activate transmit). Turn your rig's vox on. Set the level, delay and anti-trip controls so that they work well with your mic. The same settings should work with the computer since the computer audio should be matched, almost exactly, to the same level as your voice from your mic.

SWITCHES, CONNECTIONS, INDICATORS AND FEET

The back panel: You will find a yellow DC power connector for the supplied AC adapter. The RIGblaster needs approximately 12 Vdc. The center pin is positive. You may run it directly from 10 to 16 Vdc. You should understand that the RIGblaster's ground is connected to your radio's mic. and/or PTT ground and an extra power supply ground may create a ground loop problem. You may leave the RIGblaster negative/ground lead disconnected if you are using the same 12V source as your radio. Be careful with your grounding. Be sure to read the precautions on our support page if you have any questions; <http://www.westmountainradio.com/support.htm>.

The DB9 serial connector is for two way PTT control and also for CW or FSK keying. This is connected using a straight through serial extension cable connected to your computers serial port.

The 1/8" mini jack CW key output may be used with programs that directly key a CW key jack or an FSK port via a computers serial port. You should use a stereo mini plug cable to whatever connection your radio needs. The tip provides a positive pull down in respect to the sleeve, the ring is insulated and not connected.

The RCA foot switch jack may be used to key your radio via the RIGblaster and to control the RIGblaster because it is directly across the mic. PTT circuit. This jack might also be used to control an amplifier or sequencer activated by the PTT switch on your mic.

The audio level adjustment potentiometer gives a great range of adjustment to match the nominal output of the computer to your radio's mic. jack. Facing the back, clockwise is maximum audio level.

The audio input and output jacks accept standard 1/8" stereo mini plugs. These are wired in parallel, and the output may be used to monitor the audio from the computer that is fed

SETTING THE AUDIO LEVEL TO YOUR RIG:

Before using the RIGblaster you must have your radio set up properly for normal SSB operation. Changing your microphone gain or speech processor settings on your rig after setting up the RIGblaster will require that you re-adjust the RIGblaster or computer.

To have the best possible signal, you need to understand how your rig is adjusted. Modern rigs may have several adjustments for transmit audio, including; mic. gain, mic. equalization and/or transmit shift, speech compression and ALC (automatic level control). The objective of setting these adjustments is to have clean clear audio and minimum splatter or RF bandwidth.

The primary adjustment is your mic. gain. This sets the amount of audio amplification for the microphone. The speech compressor basically makes loud speech softer and soft speech louder, reducing the range between soft and loud. If your rig has transmit shift or audio equalization, you can adjust the tone quality of your audio. An ALC circuit is provided to minimize the possibility of too much audio over driving the rig and causing flattopping or splatter. You should understand the interaction of these circuits, and their adjustments. Consider your microphone and personal voice characteristics. To get the best audio from your station and work the most DX you need to set your radio carefully. Turning everything up for maximum smoke will NOT make you more intelligible....you will just be distorted.

The basic idea of adjusting your rig is to not overdrive it, and to achieve best intelligibility. Do not simply use your power output meter, but in addition use the ALC and speech compression metering too.

Turn off your speech compressor and watch the ALC meter. Set the mic. gain BELOW the correct maximum ALC indication on your loud speech. Your particular speech characteristics and operating habits must to be considered.

Adjust your transmit shift and/or transmit audio equalization (tone control) for the best on the air reports. You should consider the tone characteristics of your voice, your mic. and your rig's audio. Once you have set your tone equalization you may have to re-adjust the mic. gain.

If you use speech compression do not over do it. You should use a moderate amount. Remember that you will sound more natural without it and your shack noises will not be picked up as much. Re-check your ALC indication with the compressor on. You should ALWAYS be under the maximum correct ALC indication. With compression you should indicate more ALC activity but not necessarily higher.

Now that you have the rig set up properly for voice you can set the audio drive level from your computer to your rig. Do not change your basic mic. settings.

Turn off your rig's speech compressor. Confirm that your RF drive/transmit power control set to maximum. Double click the little yellow speaker icon in your computer's system tray. Adjust the master volume control (the one on the left) and the wave volume as high as needed to drive your rig properly; generally between 1/4 and 3/4 of the way up. The RIGblaster's "audio level" control is used to match the computer to the radio, a one time setting. Set all of these controls so that none are near all of the way up or down. Remember that all of the adjustments are all cascaded (in series), and they all interact.

Basic station hookup diagram.

Note: This diagram is a basic sound card station hookup and does not show a keying connection for CW and/or FSK. That connection is user supplied and requires an 1/8" mini jack to connect the key out of the RIGblaster to the radio's straight key input and/or FSK keying terminals.

PTT, KEYING & SWITCHING: Supplied DB9M to DB9F serial cable connected between the RIGblaster's serial jack and computer's com port. (not needed for VOX)

TRANSMIT AUDIO: Supplied 3.5 mm, 1/8" stereo phone plug patch cord from computer's line* output to RIGblaster's audio in.

RECEIVE AUDIO: Supplied 3.5mm, 1/8" stereo phone plug patch cord from radio's speaker or line out to computer's line* input.

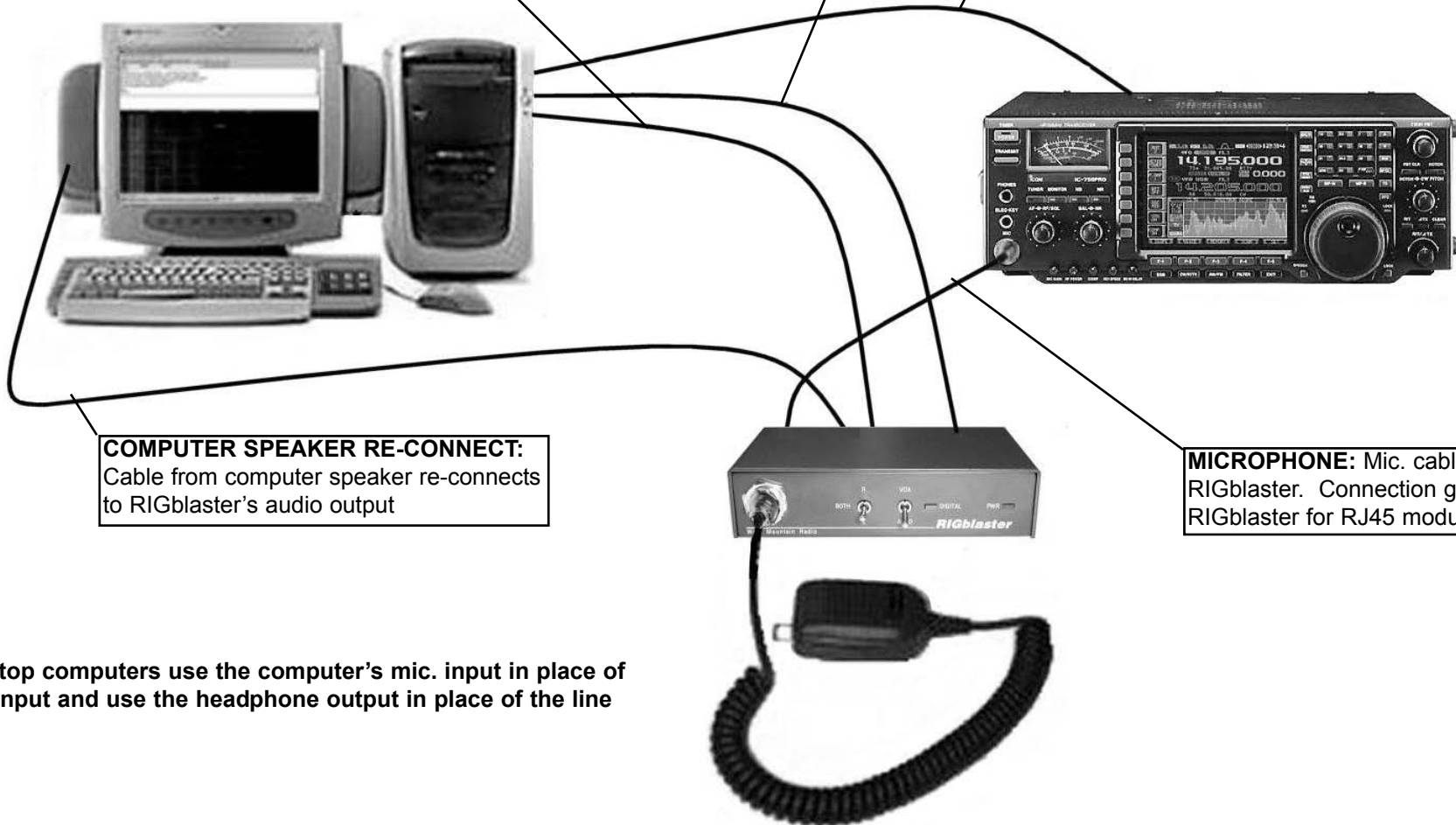

COMPUTER SPEAKER RE-CONNECT: Cable from computer speaker re-connects to RIGblaster's audio output

MICROPHONE: Mic. cable supplied with RIGblaster. Connection goes to front of RIGblaster for RJ45 modular radios.

* For laptop computers use the computer's mic. input in place of the line input and use the headphone output in place of the line output.