



VHF/UHF

DUAL BAND TRANSCEIVER

**FT-60R**

**OPERATING MANUAL**



**VERTEX STANDARD CO., LTD.**

4-8-8 Nakameguro, Meguro-Ku, Tokyo 153-8644, Japan

**VERTEX STANDARD**

**US Headquarters**

10900 Walker Street, Cypress, CA 90630, U.S.A.

**YAESU EUROPE B.V.**

P.O. Box 75525, 1118 ZN Schiphol, The Netherlands

**YAESU UK LTD.**

Unit 12, Sun Valley Business Park, Winnall Close  
Winchester, Hampshire, SO23 0LB, U.K.

**VERTEX STANDARD HK LTD.**

Unit 5, 20/F., Seaview Centre, 139-141 Hoi Bun Road,  
Kwun Tong, Kowloon, Hong Kong

---

---

# Contents

---

---

|   |           |  |           |
|---|-----------|--|-----------|
| <b>General Description .....</b>                                | <b>1</b>  | <b>Scanning .....</b>  | <b>35</b> |
| <b>Accessories &amp; Options .....</b>                          | <b>2</b>  | VFO Scanning .....   | 35        |
| <b>Controls &amp; Connections .....</b>                         | <b>3</b>  | Manual VFO Scan .....  | 35        |
| Top & Front Panel .....   | 3         | Programmed VFO Scan .....  | 36        |
| LCD .....   | 4         | Memory Scanning .....  | 37        |
| Side Panel .....  | 5         | How to Skip (Omit) a Channel<br>during Memory Scan Operation ..... | 37        |
| Keypad .....  | 6         | Preferential Memory Scan .....                                     | 38        |
| <b>Installation of Accessories .....</b>                        | <b>8</b>  | Memory Bank Scan .....   | 39        |
| Antenna Installation .....                                      | 8         | Weather Alert Scan .....   | 39        |
| Installation of FNB-83 Battery Pack .....                       | 8         | Programmable (Band Limit) Memory Scan<br>(PMS) .....               | 40        |
| Battery Charging .....  | 9         | “Priority Channel” Scanning<br>(Dual Watch) .....                  | 41        |
| Low Battery Indication .....                                    | 10        | Automatic Lamp Illumination<br>on Scan Stop .....                  | 43        |
| Installation of FBA-25A Battery Case .....                      | 10        | Band Edge Beeper .....   | 43        |
| <b>Interface of Packet TNCs .....</b>                           | <b>11</b> | <b>EPCS (Enhanced Paging &amp; Code Squelch) .....</b>             | <b>44</b> |
| <b>Operation .....</b>  | <b>12</b> | Storing the CTCSS Tone Pairs<br>for EPCS Operation .....           | 44        |
| Switching Power On and Off .....                                | 12        | Activating the Enhanced Paging &<br>Code Squelch System .....      | 45        |
| Adjusting the Audio Volume Level and<br>Squelch Setting .....   | 12        | Paging Answer Back .....   | 45        |
| Selecting the Operating Band .....                              | 13        | <b>Emergency Feature .....</b>                                     | <b>46</b> |
| Frequency Navigation .....                                      | 13        | Emergency Channel Operation .....                                  | 46        |
| Transmission .....  | 15        | Emergency Automatic ID (EAI) Feature .....                         | 46        |
| <b>Advanced Operation .....</b>                                 | <b>16</b> | <b>Smart Search Operation .....</b>                                | <b>48</b> |
| Keyboard Locking .....  | 16        | <b>Internet Connection Feature .....</b>                           | <b>49</b> |
| Keypad/LCD Illumination .....                                   | 17        | <b>ARTS (Automatic Range Transponder System) .....</b>             | <b>51</b> |
| Disabling the Keypad Beeper .....                               | 17        | <b>DTMF Operation .....</b>  | <b>54</b> |
| RF Squelch .....  | 18        | <b>Miscellaneous Settings .....</b>                                | <b>56</b> |
| Checking the Battery Voltage .....                              | 18        | Password .....   | 56        |
| <b>Repeater Operation .....</b>                                 | <b>19</b> | Programming the Key Assignment .....                               | 57        |
| Repeater Shifts .....   | 19        | Changing the Channel Steps .....                                   | 57        |
| Automatic Repeater Shift (ARS) .....                            | 19        | Changing the Receiving Mode .....                                  | 58        |
| Manual Repeater Shift Activation .....                          | 20        | Receive Battery Saver Setup .....                                  | 59        |
| <b>CTCSS/DCS Operation .....</b>                                | <b>22</b> | TX Battery Saver .....   | 59        |
| CTCSS Operation .....   | 22        | Disabling the TX/BUSY Indicator .....                              | 60        |
| DCS Operation .....   | 23        | Automatic Power-Off (APO) Feature .....                            | 60        |
| Tone Search Scanning .....                                      | 24        | Transmitter Time-Out Timer (TOT) .....                             | 61        |
| CTCSS/DCS Bell Operation .....                                  | 25        | Busy Channel Lock-Out (BCLO) .....                                 | 61        |
| Split Tone Operation .....                                      | 25        | Mono Band Operation .....  | 62        |
| Tone Calling (1750 Hz) .....                                    | 26        | Changing the TX Deviation Level .....                              | 62        |
| <b>Memory Mode .....</b>  | <b>27</b> | DCS Code Inversion .....   | 63        |
| Memory Storage .....  | 28        | <b>Reset Procedures .....</b>                                      | <b>64</b> |
| Storing Independent<br>Transmit Frequencies (“Odd Split”) ..... | 28        | <b>Cloning .....</b>   | <b>65</b> |
| Memory Recall .....   | 29        | <b>Set Mode .....</b>  | <b>66</b> |
| HOME Channel Memory .....                                       | 29        | <b>Specifications .....</b>  | <b>79</b> |
| Labeling Memories .....   | 30        | <b>“AUTO” Mode Preset Operating Parameters ....</b>                | <b>80</b> |
| Memory Offset Tuning .....                                      | 31        |  |           |
| Deleting Memories .....   | 32        |  |           |
| Moving Memory Data to the VFO .....                             | 32        |  |           |
| Memory Bank Operation .....                                     | 33        |  |           |
| Memory Only Mode .....  | 34        |  |           |
| Weather Broadcast Channels .....                                | 34        |  |           |

# GENERAL DESCRIPTION

The **FT-60R** is a dual band FM transceiver with extensive receive frequency coverage, providing local-area two-way amateur communications along with unmatched monitoring capability.

The **FT-60R**'s small size allows you to take it anywhere - hiking, skiing, or while walking around town - and its operating flexibility brings the user many avenues of operating enjoyment. Its incredibly tiny **FNB-83** Rechargeable Nickel-Metal Hydride Battery Pack provides up to 5 Watts of transmit power on 144 MHz and 430 MHz Amateur Bands. Besides 144- and 430-MHz transceive operation, the **FT-60R** provides receive coverage of the VHF and UHF TV bands, the VHF AM aircraft band, and a wide range of commercial and public safety frequencies!

New and exciting features of the **FT-60R** are the Emergency Automatic ID (EAI) function, that will automatically cause your **FT-60R** to transmit your callsign and engage your rig's microphone, even if you are disabled and unable to press the **PTT** switch; Enhanced Paging and Code Squelch (EPCS), that allows you to page a particular station and only receive calls from that station, if desired; and a security Password feature, that will allow you to turn on and operate your transceiver only after you enter your Password.

Additional features include a convenient access key for Vertex Standard's **WIRES™** (Wide-coverage Internet Repeater Enhancement System), a transmit Time-Out Timer (TOT), Automatic Power-Off (APO), Automatic Repeater Shift (ARS), Yaesu's exclusive **ARTS™** (Auto-Range Transponder System) which "beeps" the user when you move out of communications range with another **ARTS™** equipped station, plus provision for reduction of the TX deviation in areas of high channel congestion. And an RF squelch circuit allows the owner to set the squelch to open at a programmable setting of the S-Meter, thus reducing guesswork in setting the squelch threshold.

We appreciate your purchase of the **FT-60R**, and encourage you to read this manual thoroughly, so as to learn about the many exciting features of your exciting new Yaesu hand-held transceiver!

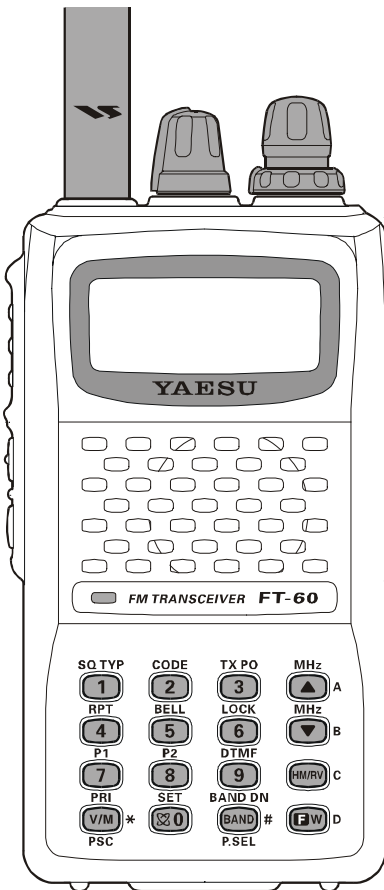

# ACCESSORIES & OPTIONS

---

---

## SUPPLIED ACCESSORIES

---

---

- FNB-83** 7.2 V, 1,400 mAh  
Rechargeable Nickel-Metal Hydride Battery Pack
  - NC-88B/C\*** Overnight Battery Charger (10-Hour)
  - Belt Clip
  - Antenna
  - Operating Manual
  - Warranty Card
- 
- 

## AVAILABLE OPTIONS

---

---

- FNB-83** 7.2 V, 1,400 mAh  
Rechargeable Nickel-Metal Hydride Battery Pack
- FBA-25A** Compact Dry Battery Case for 6 AA-size cells
- VAC-370B/C\*** Desktop Rapid Charger (1.5-Hour)
- NC-88B/C\*** Overnight Battery Charger (10-Hours)
- CN-3** BNC-to-SMA Adapter
- CT-27** Cloning Cable
- CT-44** Microphone Adapter
- E-DC-5B** DC Cable with Cigarette-Lighter Adapter
- E-DC-6** DC Cable; plug and wire only
- MH-34B4B** Speaker/Microphone
- MH-37A4B** Ear piece/Microphone
- VC-25** VOX Headset

※: “**B**” suffix is for use with 100-120 VAC, “**C**” suffix is for use with 230-240 VAC.

*Availability of accessories may vary. Some accessories are supplied as standard per local requirements, while others may be unavailable in some regions. This product is designed to perform optimally when used with genuine Yaesu accessories. Vertex Standard shall not be liable for any damage to this product and/or accidents such as fire, leakage or explosion of a battery pack, etc., caused by the malfunction of non-Yaesu accessories. Consult your Yaesu dealer for details regarding these and any newly-available options. Connection of any non-Yaesu-approved accessory, should it cause damage, may void the Limited Warranty on this apparatus.*

# CONTROL & CONNECTIONS (TOP & FRONT PANEL)

## ① Antenna Jack

Connect the supplied rubber flex antenna (or another antenna presenting a 50-Ohm impedance) here.

## ② VOL/PWR Knob

Turn this control clockwise to turn the radio on and to increase the volume. Counter-clockwise rotation into the click-stop will turn the radio off.

## ③ TX/BUSY Indicator Lamp

This indicator glows green when the squelch opens, and turns red during transmit.

## ④ DIAL Knob

This (inner) 20-position detented rotary switch is used for setting the operating frequency, and also is used for menu selections and other adjustments.

## ⑤ SQL Knob

This (outer) control is used to silence background noise on the receiver. It should be advanced clockwise just to the point where the noise is silenced (and the green "BUSY" indicator turns off).

## ⑥ LCD (Liquid Crystal Display)

The display shows current operating condition, as indicated on the next page.

## ⑦ Speaker

The internal speaker is located here.

## ⑧ Microphone

The internal microphone is located here.

## ⑨ Keypad

These 16 keys select many of most important operating features on the **FT-60R**. The functions of the keys are described in detail on the pages to follow.

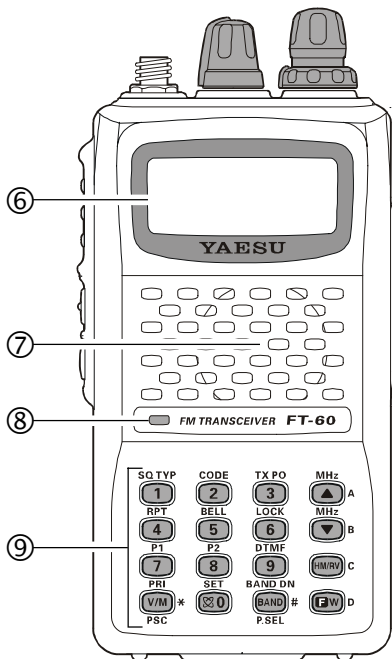
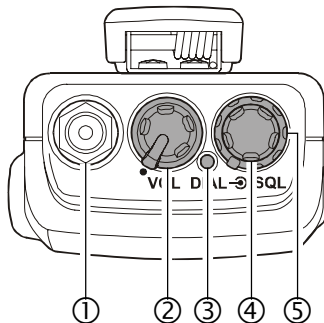

# CONTROL & CONNECTIONS (LCD)

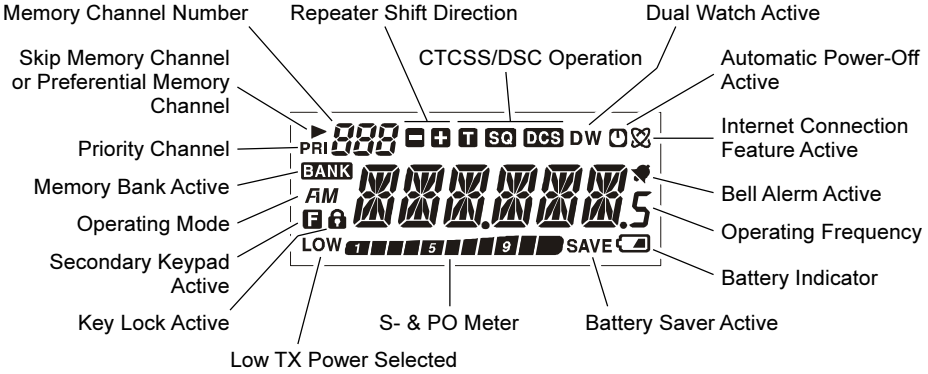

# CONTROL & CONNECTIONS (SIDE PANEL)

## ① PTT (Push To Talk) Switch

Press this switch to transmit, and release it (to receive) after your transmission is completed.

## ② MONI Switch

Pressing this switch disables the noise squelching action, allowing you to hear very weak signals near the background noise level temporarily.

Press the [F/W] key on the keypad first, then press this switch to “open” the squelch continuously. Press this switch again to resume normal (quiet) monitoring.

## ③ LAMP Switch

Pressing this switch illuminates the LCD and keypad for five seconds, after which the back-lighting will automatically turn off.

Press the [F/W] key on the keypad first, then press this switch to activate the back-lighting lamp continuously. To turn the lamp off, press this switch again.

You can change the primary (press key) function of this switch, if you prefer. See page 17 for details.

## ④ MIC/SP Jack

This four-conductor miniature jack provides connection points for microphone audio, earphone audio, PTT, and ground.

## ⑤ EXT DC Jack

This coaxial DC jack allows connection to an external DC power source (6-16V DC). The center pin of this jack is the Positive (+) connection.

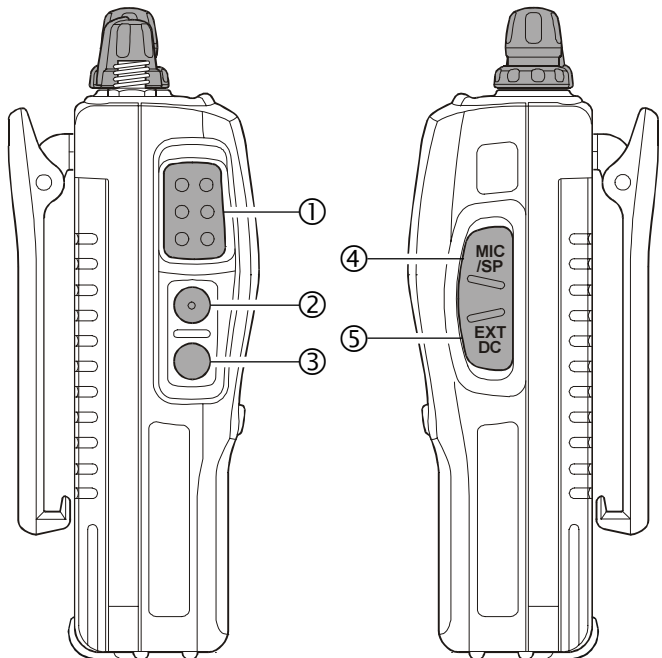









# CONTROL & CONNECTIONS (KEYPAD)

|  | SQ TYP<br><b>1</b>  | CODE<br><b>2</b>   |
|--|---|--|
| <b>Primary Function</b><br>(PRESS KEY)           | Frequency entry digit "1"   | Frequency entry digit "2"  |
| <b>Secondary Function</b><br>(PRESS [F/W] + KEY) | Activates the CTCSS or DCS Operation  | Selects the CTCSS tone or DCS code number                              |
| <b>Third Function</b><br>(PRESS & HOLD KEY)      | Recalls the "Weather" broadcast channel bank  | Activates the ARTS feature   |
|  | RPT<br><b>4</b>   | BELL<br><b>5</b>   |
| <b>Primary Function</b><br>(PRESS KEY)           | Frequency entry digit "4"   | Frequency entry digit "5"  |
| <b>Secondary Function</b><br>(PRESS [F/W] + KEY) | Selects the direction of the uplink frequency shift (either "-", "+," or "simplex") during repeater operation | Selects the CTCSS/DCS Bell ringer repetitions                          |
| <b>Third Function</b><br>(PRESS & HOLD KEY)      | Activates the EMERGENCY function  | None   |
|  | P1 ×1<br><b>7</b>   | P2 ×1<br><b>8</b>  |
| <b>Primary Function</b><br>(PRESS KEY)           | Frequency entry digit "7"   | Frequency entry digit "8"  |
| <b>Secondary Function</b><br>(PRESS [F/W] + KEY) | Activates the EPCS (Enhanced Paging & Code Squelch) feature   | Selects the Memory Scan "Skip" channel-selection mode                  |
| <b>Third Function</b><br>(PRESS & HOLD KEY)      | None  | None   |
|  | PRI<br>V/M  | SET<br><b>0</b>  |
| <b>Primary Function</b><br>(PRESS KEY)           | Switches the frequency control between the VFO and Memory Systems   | Activates the Internet Connection feature<br>Frequency entry digit "0" |
| <b>Secondary Function</b><br>(PRESS [F/W] + KEY) | Activates the Priority (Dual Watch) function  | Engages the Set (Menu) Mode  |
| <b>Third Function</b><br>(PRESS & HOLD KEY)      | Starts the programmable scanner upward (toward a higher frequency or a higher channel number)                 | Enables Internet access code selection                                 |

×1: You can program the secondary (press [F/W] key +) function of the key to another function, if desired. See page 57 for details.



# CONTROL & CONNECTIONS (KEYPAD)

|  |  |   |
|--|--|---|
|  | TX PO<br>                             | MHz<br>        |
| <b>Primary Function</b><br>(PRESS KEY)           | Frequency entry digit "3"  | Increases the VFO frequency by one step or moves the memory channel to the next-highest channel |
| <b>Secondary Function</b><br>(PRESS [F/W] + KEY) | Selects the desired transmit power output level  | Tunes the VFO frequency upward in 1 MHz steps   |
| <b>Third Function</b><br>(PRESS & HOLD KEY)      | Activates the Smart Search feature   | Starts the scanner upward (toward a higher frequency or a higher channel number)                |
|  | LOCK<br>                              | MHz<br>        |
| <b>Primary Function</b><br>(PRESS KEY)           | Frequency entry digit "6"  | Decreases the VFO frequency by one step or moves the memory channel to the next-lowest channel  |
| <b>Secondary Function</b><br>(PRESS [F/W] + KEY) | Activates the Key Lockout feature  | Tunes the VFO frequency downward in 1 MHz steps   |
| <b>Third Function</b><br>(PRESS & HOLD KEY)      | Activates the Key Lockout feature  | Starts the scanner downward (toward a lower frequency or a lower channel number)                |
|  | DTMF<br>                              |  *2            |
| <b>Primary Function</b><br>(PRESS KEY)           | Frequency entry digit "9"  | Reverses the transmit and receive frequencies while working through a repeater                  |
| <b>Secondary Function</b><br>(PRESS [F/W] + KEY) | Selects the DTMF mode  | Switches to the "Home" (favorite frequency) Channel   |
| <b>Third Function</b><br>(PRESS & HOLD KEY)      | None   | None  |
|  | BAND DN<br>                         |              |
| <b>Primary Function</b><br>(PRESS KEY)           | Moves operation to the next-highest frequency band<br>Activates the "Memory Tune" mode while in the Memory Recall mode | Activates the "Secondary" key function  |
| <b>Secondary Function</b><br>(PRESS [F/W] + KEY) | Moves operation to the next-lowest frequency band  | Disables the "Secondary" key function   |
| <b>Third Function</b><br>(PRESS & HOLD KEY)      | Selects the bandwidth for the programmable scanner while in the VFO mode   | Activates the "Memory Write" mode (for memory channel storage)                                  |

\*2: You can exchange the function between primary (press key) function and secondary (press [F/W] key +) function, if desired. See page 75 for details.

# INSTALLATION OF ACCESSORIES

## ANTENNA INSTALLATION

The supplied antenna provides good results over the entire frequency range of the transceiver. However, for enhanced reception on certain non-Amateur frequencies, you may wish to connect an antenna designed specifically for that frequency range, as the supplied antenna is necessarily a compromise outside the Amateur bands, and cannot be expected to provide high performance at all frequencies.

To install the supplied antenna, hold the bottom end of the antenna, then screw it onto the mating connector on the transceiver until it is snug. Do not over-tighten by use of extreme force.

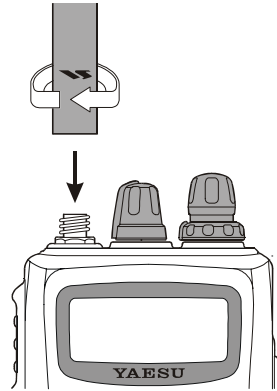

### Notes:

- Never transmit without having an antenna connected.
- When installing the supplied antenna, never hold the *upper* part of the antenna while screwing it onto the mating connector on the transceiver.
- If using an external antenna for transmission, ensure that the SWR presented to the transceiver is 1.5:1 or lower, to avoid excessive feedline loss.

## INSTALLATION OF FNB-83 BATTERY PACK

The **FNB-83** is a high-performance Ni-MH battery providing high capacity in a compact package. Under normal use, the **FNB-83** may be used for approximately 300 charge cycles, after which operating time may be expected to decrease. If you have an old battery pack which is displaying capacity which has become diminished, you should replace the pack with a new one.

Installation of the battery is easy and quick:

- ❑ Insert the battery pack into the battery compartment on the back of the radio while tilting the Belt Clip outward, then close the Battery Pack Latch until it locks in place with a “Click.”
- ❑ To remove the battery, turn the radio off and remove any protective cases. Open the Battery Pack Latch on the bottom of the radio, then slide the battery downward and out from the radio while tilting the Belt Clip out of the way.

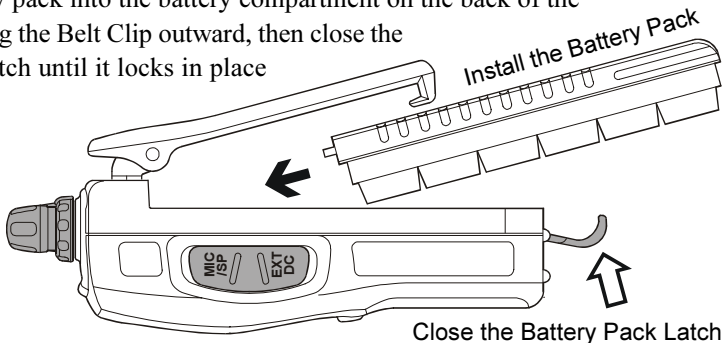

# INSTALLATION OF ACCESSORIES

## BATTERY CHARGING

If the battery has never been used, or its charge is depleted, it may be charged by connecting the **NC-88** Overnight Battery Charger, as shown in the illustration, to the **EXT DC** jack. If only 12 ~ 16 Volt DC power is available, the optional **E-DC-5B** DC Adapter (with its cigarette lighter plug) may also be used for charging the battery.

A fully-discharged pack will be charged completely in **10 hours**. Disconnect the **NC-88** from the **EXT DC** jack and the AC line outlet.

### Important Note

- ❑ *The **NC-88** is not designed to power the transceiver for operation (reception or transmission).*
- ❑ *Do not leave the **NC-88** connected to the transceiver for continuous periods in excess of 24 hours. Long term overcharging can degrade the Ni-MH battery pack and significantly shorten its useful life.*
- ❑ *Please be advised that the **NC-88** may contribute noise to TV and radio reception in the immediate vicinity, so we do not recommend its use adjacent to such devices.*

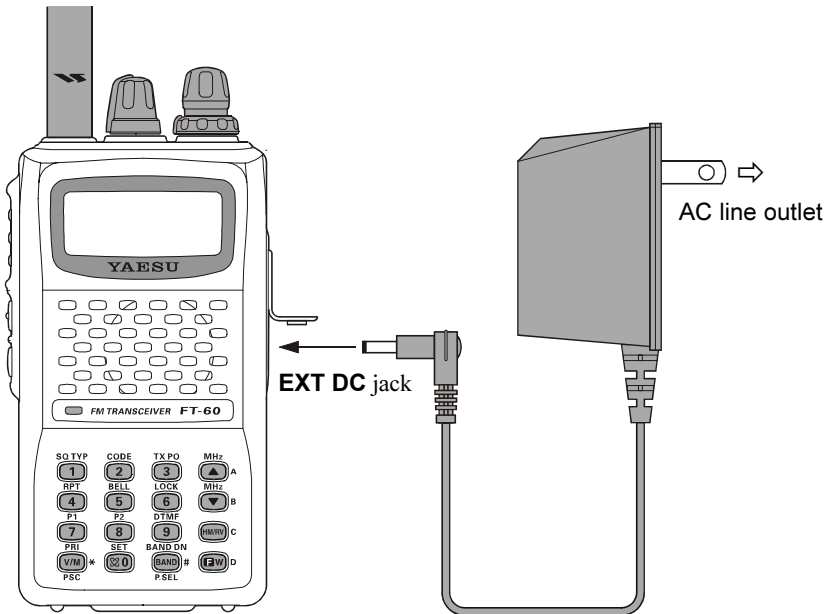



# INSTALLATION OF ACCESSORIES

---

## LOW BATTERY INDICATION

---

- As your battery discharges during use, the voltage will gradually become lower. When the battery voltage is becoming too low for reliable operation, the “” icon will blink on the LCD display, indicating that the battery pack must be recharged before further use.
- Avoid recharging Ni-MH batteries before the “” indicator is observed, as this can degrade the charge capacity of your Ni-MH battery pack.

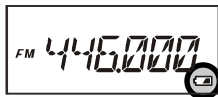

## INSTALLATION OF FBA-25A ALKALINE BATTERY CASE (OPTION)

---

The optional **FBA-25A** Battery Case allows operation of the **FT-60R** using six “AA” size Alkaline batteries.

When installing batteries, insert the (–) end first, then press in the (+) end so the battery snaps into place. Always replace all six batteries at the same time, paying attention to the polarity indicated inside the case.

The **FBA-25A** must not be used with rechargeable cells. The **FBA-25A** does not contain the thermal and over-current protection circuits (provided in the “FNB” series of Ni-MH Battery Packs) required when utilizing Ni-Cd and Ni-MH cells.

*Note that the power output and battery life will be much shorter when using Alkaline AA cells. They should be considered an emergency backup power source only, for this reason.*

# INTERFACE OF PACKET TNCs

The **FT-60R** may be used for Packet operation, using the optional **CT-44** microphone adapter (available from your Yaesu dealer) for easy interconnection to commonly-available connectors wired to your TNC. You may also build your own cable, using a four-conductor miniature phone plug, per the diagram below.

The audio level from the receiver to the TNC may be adjusted by using the **VOL** knob, as with voice operation. The input level to the **FT-60R** from the TNC should be adjusted at the TNC side; the optimum input voltage is approximately 5 mV at 2000 Ohms.

Be sure to turn the transceiver and TNC off before connecting the cables, so as to prevent voltage spikes from possibly damaging your transceiver.

When you are operating on Packet, switch the Receive Battery Saver OFF, as the “sleep” cycle may “collide” with the beginning of an incoming Packet transmission, causing your TNC not to receive the full data burst. See page 59 for details regarding Battery Saver setup.

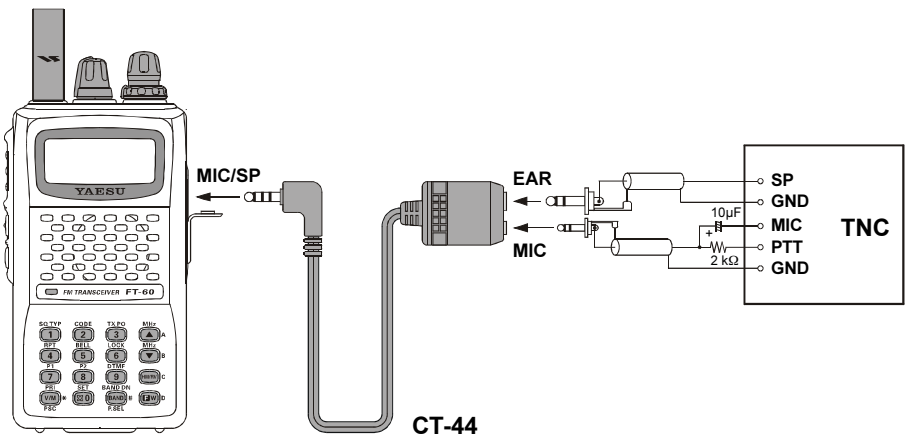

# OPERATION



*Hi! I'm R. F. Radio, and I'll be helping you along as you learn the many features of the FT-60R. I know you're anxious to get on the air, but I encourage you to read the "Operation" section of this manual as thoroughly as possible, so you'll get the most out of this fantastic new transceiver. Now. . .let's get operating!*

---

## SWITCHING POWER ON AND OFF

---

- Be sure the Battery Pack is installed, and that the battery is fully charged. Connect the antenna to the top panel Antenna jack.
- Rotate the top panel's **VOL** knob out of the click-stop to turn on the radio. The current DC supply voltage will be indicated on the display for 2 seconds. After this 2 second interval, the display will resume its normal indication of the operating frequency.
- To turn the radio off, turn the **VOL** knob fully counter-clockwise into the click stop position.

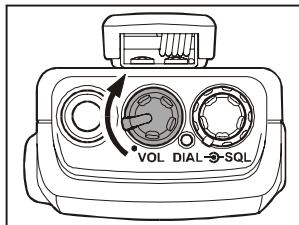

---

## ADJUSTING THE AUDIO VOLUME LEVEL AND SQUELCH SETTING

---

- At first, set the **SQL** knob fully counter-clockwise. Now, you may rotate the **VOL** knob to adjust the receiver level for a comfortable listening level, using the background noise as a reference.
- To set the squelch, turn the **SQL** knob clockwise, slightly past the point where the background noise is muted. This is the point of best sensitivity to weak signals, and we recommend that you not rotate the **SQL** knob very much past the point where the background noise is just silenced.

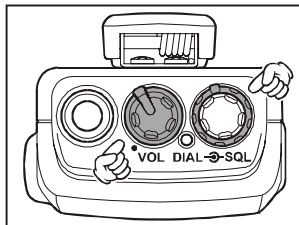

*1) A special "RF Squelch" feature is provided on this radio. This feature allows you to set the squelch so that only signals exceeding a certain S-meter level will open the squelch. See page 18 for details.*

*2) If you're operating in an area of high RF pollution, you may need to consider "Tone Squelch" operation using the built-in CTCSS Decoder. This feature will keep your radio quiet until a call is received from a station sending a carrier which contains a matching (subaudible) CTCSS tone. Or, if your friends have radios equipped with DCS (Digital Coded Squelch) like your FT-60R has, try using that mode for silent monitoring of busy channels.*

## SELECTING THE OPERATING BAND

- Press the [BAND(BAND DN)] key repetitively. You will see the LCD indication move toward a higher frequency band each time you press the [BAND(BAND DN)] key.

850 MHz → 144 MHz →  
 250 MHz → 350 MHz →  
 430 MHz → 850 MHz ……

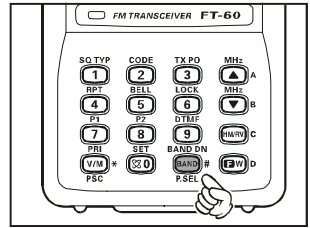

- If you wish to move the operating band selection downward (toward a lower frequency band), press the [F/W] key first, then press the [BAND(BAND DN)] key.

350 MHz → 250 MHz →  
 144 MHz → 850 MHz →  
 430 MHz → 350 MHz ……

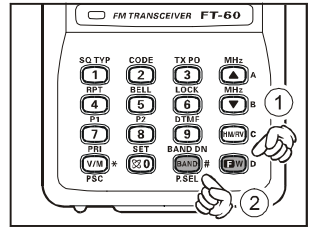

- Once you have selected the desired band, you may initiate manual tuning (or scanning) per the discussion in the next chapter.

| BAND         | FREQUENCY RANGE       |
|--------------|-----------------------|
| 144 MHz Band | 108.000 - 200.000 MHz |
| 250 MHz Band | 200.000 - 300.000 MHz |
| 350 MHz Band | 300.000 - 400.000 MHz |
| 430 MHz Band | 400.000 - 520.000 MHz |
| 850 MHz Band | 700.000 - 999.990 MHz |

## FREQUENCY NAVIGATION

The **FT-60R** will initially be operating in the “VFO” mode, a channelized system which allows free tuning throughout the currently-selected operating band.

Three basic frequency navigation methods are available on the **FT-60R**:

### 1) Tuning Dial

Rotation of the **DIAL** allows tuning in the pre-programmed steps established for the current operating band. Clockwise rotation of the **DIAL** causes the **FT-60R** to be tuned toward a higher frequency, while counter-clockwise rotation will lower the operating frequency.

If you press the [F/W] key momentarily, then rotate the **DIAL**, frequency steps of 1 MHz will be selected. This feature is extremely useful for making rapid frequency excursions over the wide tuning range of the **FT-60R**.

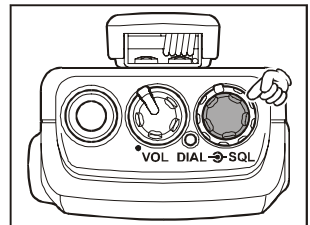

# OPERATION

## FREQUENCY NAVIGATION

### 2) Direct Keypad Frequency Entry

The desired operating frequency may be entered directly from the keypad.

To enter a frequency from the keypad, just press the numbered digits on the keypad in the proper sequence.

Examples:

To enter 146.560 MHz, press [1] → [4] → [6] → [5] → [6] → [0]

To enter 146.5625 MHz (in 12.5 kHz), [1] → [4] → [6] → [5] → [6] → [2]

### 3) Scanning

Press and hold in either the [▲(MHz)] or [▼(MHz)] key for one second to initiate upward or downward scanning, respectively (Manual VFO Scan).

For scanning within a limited sub-band range, from the VFO mode, press and hold in the [V/M(PRI)] key for one second to begin scanning toward a higher frequency within the previously-defined sub-band (Programmed VFO Scan). Details regarding sub-band setup may be found on page 36.

If you wish to reverse the direction of the scan (i.e. toward a lower frequency, instead of a higher frequency), just rotate the **DIAL** one click in the counter-clockwise direction *while the FT-60R is scanning*. The scanning direction will be reversed. To revert to scanning toward a higher frequency once more, rotate the **DIAL** one click clockwise.

The scanner will stop when it receives a signal strong enough to break through the Squelch threshold. The **FT-60R** will then hold on that frequency according to the setting of the “RESUME” mode (Set Mode Item 35: RESUME). Press the **PTT** switch momentarily to cancel the scanning. This only stops the scan; it does not cause transmission to occur. See page 35 for details regarding Scan Operation.

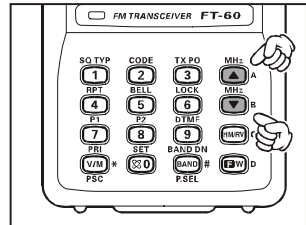

(Manual VFO Scan)

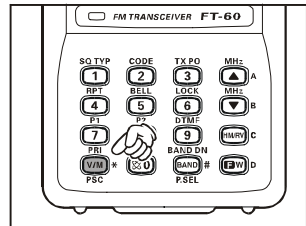

(Programmed VFO Scan)



## TRANSMISSION

Once you have set up an appropriate frequency inside one of the 144 MHz or 430 MHz Amateur bands on which the **FT-60R** can transmit, you're ready to go on the air! These are the most basic steps; more advanced aspects of transmitter operation will be discussed later.

- ❑ To transmit, press the **PTT** switch, and speak into the front panel microphone (located in the lower left-hand corner of the speaker grille) in a normal voice level. The **TX/BUSY** indicator will glow red during transmission.
- ❑ To return to the receive mode, release the **PTT** switch.
- ❑ During transmission, the relative power level will be indicated on the bar graph at the bottom of the LCD; full scale deflection confirms "**High Power**" operation, while deflection of two bars indicates "**Low Power**" operation. Five bars indicates "**Medium Power**" operation. Additionally, the "**LOW**" icon will appear at the bottom of the display while operating on the "**Low Power**" and "**Medium Power**" settings.

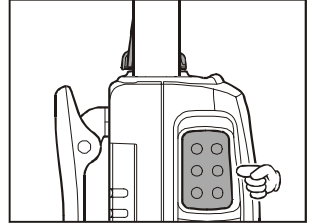

*1) If you're just talking to friends in the immediate area, you'll get much longer battery life by switching to Low Power operation, described in the next chapter. And don't forget: always have an antenna connected when you transmit.*

*2) Transmission is possible only on the 144 MHz and 430 MHz bands.*

### Changing the Transmitter Power Level

To change the power level:

- ❑ Press the **[F/W]** key, then press the **[3(TX PO)]** key. The LCD shows the current power output level.
- ❑ Rotate the **DIAL** knob to select the desired power output level. Available selections are "HIGH" (5 W), "MID" (2 W), and "LOW" (0.5 W).
- ❑ When you have made your choice, press the **PTT** switch to save the new setting and return to normal operation.

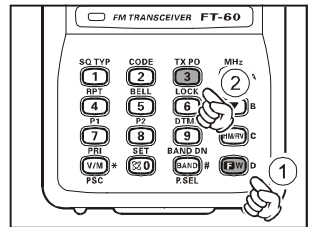

*1) The FT-60R is smart! You can set up Low power on the 144 MHz band, while leaving 430 MHz on High power, and the radio will remember the different settings on both bands. And when you store memories, you can store the power output settings separately in each memory, so you don't waste battery power when using very close-in repeaters!*

*2) When you are operating on the "Low" or "Medium" power setting, you can press the [F/W] key, when press the PTT switch, to cause the FT-60R to transmit (temporarily) on High power. After one transmission, the power level will revert to the previously-selected ("Low" or "Medium" power) setting.*

# ADVANCED OPERATION

Now that you've mastered the basics of **FT-60R** operation, let's learn more about some of the really neat features.

## KEYBOARD LOCKING

In order to prevent accidental frequency change or inadvertent transmission, various aspects of the **FT-60R**'s **DIAL** and keypad may be locked out. The possible lockout combinations are:

- LK KEY: Just the front panel keypad is locked out
- LKDIAL: Just the top panel **DIAL** is locked out
- LK K+D: Both the keypad and **DIAL** are locked out (factory default)
- LK PTT: The **PTT** switch is locked out (TX not possible)
- LK P+K: Both the **PTT** switch and keypad are locked out
- LK P+D: Both the **PTT** switch and **DIAL** are locked out
- LK ALL: All of the above are locked out

To lock out some or all of the keys:

1. Press the [**F/W**] key, then press the [**0(⊗)SET**] key to enter the Set mode.
2. Rotate the **DIAL** knob to select Set Mode Item 25: LOCK.
3. Press the [**F/W**] key momentarily to enable adjustment of this Item.
4. Rotate the **DIAL** knob to choose between one of the locking schemes as outlined above.
5. When you have made your selection, press the **PTT** switch to save the new setting and return to normal operation.

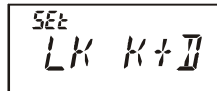
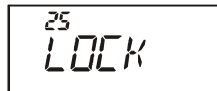

To activate the locking feature, (1) *press and hold* in the [**6(LOCK)**] key for one second, or (2) press the [**F/W**] key, then press the [**6(LOCK)**] key. The “**🔒**” icon will appear on the LCD. To cancel locking, repeat this process.

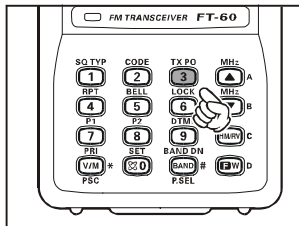
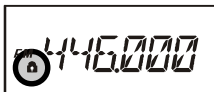

## KEYPAD/LCD ILLUMINATION

Your **FT-60R** includes a reddish illumination lamp which aids in nighttime operation. The reddish illumination yields clear viewing of the display in a dark environment, with minimal degradation of your night vision.

Three options for activating the lamp are provided:

- KEY Mode:** Illuminates the Keypad/LCD lamp for five seconds when you rotate the **DIAL** knob or press the keypad or any switch (except **PTT** switch). This is the factory-programmed default setting.
- 5SEC Mode:** Illuminates the Keypad/LCD lamp for five seconds when you press the **LAMP** switch momentarily.
- TOGGLE Mode:** Toggles the Keypad/LCD lamp on and off when you press the **LAMP** switch momentarily.

Here is the procedure for setting up the Lamp operating mode:

1. Press the **[F/W]** key, then press the **[0(⊗)SET]** key to enter the Set mode.
2. Rotate the **DIAL** knob to select Set Mode Item 24: LAMP.
3. Press the **[F/W]** key momentarily to enable adjustment of this Item.
4. Rotate the **DIAL** knob to select one of the three modes described above.
5. When you have made your choice, press the **PTT** switch to save the new setting and return to normal operation.

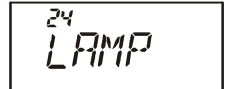

24  
LAMP

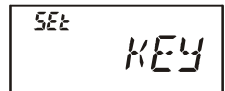

SET  
KEY



*Press the **[F/W]** key first, then press the **LAMP** switch to illuminate the Keypad/LCD lamp continuously until you press the **LAMP** key again, irrespective of the Lamp mode programmed per the above instructions.*

## DISABLING THE KEYPAD BEEPER

A keypad beeper provides useful audible feed back whenever a keypad is pressed.

If you want to turn the beep off:

1. Press the **[F/W]** key, then press the **[0(⊗)SET]** key to enter the Set mode.
2. Rotate the **DIAL** knob to select Set Mode Item 6: BEEP.
3. Press the **[F/W]** key momentarily to enable adjustment of this Item.
4. Rotate the **DIAL** knob to change the setting to “OFF.”
5. Press the **PTT** switch to save the new setting and return to normal operation.
6. To turn the beep back on again, select “KEY” or “KEY+SC (factory default)” in step 4 above.

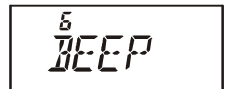

6  
BEEP

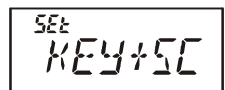

SET  
KEY+SC

**KEY:** The beeper sounds when you press the keypad.

**KEY+SC:** The beeper sounds when you press the keypad, or when the scanner stops.

# ADVANCED OPERATION

---

## RF SQUELCH

---

A special RF Squelch feature is provided on this radio. This feature allows you to set the squelch so that only signals exceeding a certain S-meter level will open the squelch.

To set up the RF squelch circuit for operation, use the following procedure:

1. Press the **[F/W]** key, then press the **[0(⊗)SET]** key to enter the Set mode.
2. Rotate the **DIAL** knob to select Set Mode Item 37: RF SQL.
3. Press the **[F/W]** key momentarily to enable adjustment of this Item.
4. Rotate the **DIAL** knob to select the desired signal strength level for the squelch threshold (S-1, S-2, S-3, S-4, S-5, S-6, S-8, S-FULL, or OFF).
5. Press the **PTT** switch to save the new setting and return to normal operation.
6. Finally, rotate the **SQL** knob fully clockwise.

The LCD display shows the number '37' at the top, followed by 'RF' and 'SQL' on the next line.

The LCD display shows the word 'SET' at the top, followed by '5-8' on the next line.

---

## CHECKING THE BATTERY VOLTAGE

---

The **FT-60R**'s microprocessor includes programming which will measure the current battery voltage.

1. Press the **[F/W]** key, then press the **[0(⊗)SET]** key to enter the Set mode.
2. Rotate the **DIAL** knob to select Set Mode Item 12: DC VLT.
3. Press the **[F/W]** key momentarily to display the current DC voltage being supplied.
4. Press and hold the **[F/W]** key for one second to return to normal operation.

The LCD display shows the number '12' at the top, followed by 'DC' and 'VLT' on the next line.

The LCD display shows the word 'SET' at the top, followed by '7.2 V' on the next line.

# REPEATER OPERATION

Repeater stations, usually located on mountaintops or other high locations, provide a dramatic extension of the communication range for low-powered hand-held or mobile transceivers. The **FT-60R** includes a number of features which make repeater operation simple and enjoyable.

---

## REPEATER SHIFTS

---

Your **FT-60R** has been configured, at the factory, for the repeater shifts customary in your country. For the 144 MHz band shift will be 600 kHz; on the 430 MHz band, the shift may be 1.6 MHz, 7.6 MHz, or 5 MHz (USA version).

Depending on the part of the band in which you are operating, the repeater shift may be either downward (⊖) or upward (⊕), and one of these icons will appear at the top of the LCD when repeater shifts have been enabled.

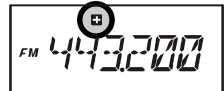

---

## AUTOMATIC REPEATER SHIFT (ARS)

---

The **FT-60R** provides a convenient Automatic Repeater Shift feature, which causes the appropriate repeater shift to be applied automatically whenever you tune into the designated repeater sub-bands in your country. These sub-bands are shown below.

If the ARS feature does not appear to be working, you may have accidentally disabled it.

To re-enable ARS:

1. Press the **[F/W]** key, then press the **[0(⊗)SET]** key to enter the Set mode.
2. Rotate the **DIAL** knob to select Set Mode Item 4: ARS.
3. Press the **[F/W]** key momentarily to enable adjustment of this Item.
4. Rotate the **DIAL** knob to select “ARS. ON.”
5. When you have made your selection, press the **PTT** switch to save the new setting and return to normal operation.

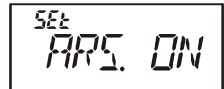
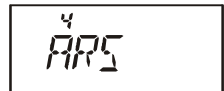

# REPEATER OPERATION

## MANUAL REPEATER SHIFT ACTIVATION

If the ARS feature has been disabled, or if you need to set a repeater shift direction other than that established by the ARS, you may set the direction of the repeater shift manually.

To do this:

1. Press the **[F/W]** key, then press the **[0(⊗)SET]** key to enter the Set mode.
2. Rotate the **DIAL** knob to select Set Mode Item 38: RPT.MOD.
3. Press the **[F/W]** key momentarily to enable adjustment of this Item.
4. Rotate the **DIAL** knob to select the desired shift among “RPT.-,” “RPT.+,” and “RPT.OFF.”
5. When you have made your selection, press the **PTT** switch to save the new setting and return to normal operation.



38  
RPT.MOD

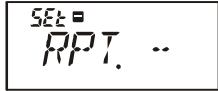

SET =  
RPT. -



*If you make a change in the shift direction, but still have Automatic Repeater Shift still engaged (see previous section), when you change frequency (by rotating the DIAL knob, for example) the ARS will over-ride your manual setting of the shift direction. Turn ARS off if you do not wish this to happen.*

### Changing the Default Repeater Shifts

If you travel to a different region, you may need to change the default repeater shift so as to ensure compatibility with local operating requirements.

To do this, follow the procedure below:

1. Set the **FT-60R**'s frequency to the band on which you wish to change the default repeater shift (144 MHz or 430 MHz Amateur Band).
2. Press the **[F/W]** key, then press the **[0(⊗)SET]** key to enter the Set mode.
3. Rotate the **DIAL** knob to select Set Mode Item 45: SHIFT.
4. Press the **[F/W]** key momentarily to enable adjustment of this Item.
5. Rotate the **DIAL** knob to select the new repeater shift magnitude.
6. When you have made your selection, press the **PTT** switch to save the new setting and return to normal operation.

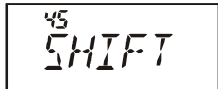

45  
SHIFT

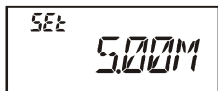

SET  
500M



*If you just have one “odd” split that you need to program, don’t change the “default” repeated shifts using this Set Mode Item. Enter the transmit and receive frequencies separately, as shown on page 28.*

## MANUAL REPEATER SHIFT ACTIVATION

### Checking the Repeater Uplink (Input) Frequency

It often is helpful to be able to check the uplink (input) frequency of a repeater, to see if the calling station is within direct (“Simplex”) range.

To do this, just press the [HM/RV] key. You’ll notice that the display has shifted to the repeater uplink frequency. Press the [HM/RV] key again to cause operation to revert to normal monitoring of the repeater downlink (output) frequency. While you are listening on the input frequency to the repeater using the [HM/RV] key, the repeater offset icon will blink.

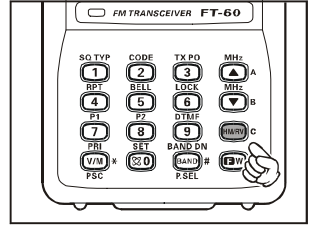

*The configuration of this key may be set either to “RV” (for checking the input frequency of a repeater), or “HM” (for instant switching to the “Home” channel for the band you are operating on). To change the configuration of this key, use Set Mode Item 36: REV/HM. See page 75.*

# CTCSS/DCS OPERATION

## CTCSS OPERATION

Many repeater systems require that a very-low-frequency audio tone be superimposed on your FM carrier in order to activate the repeater. This helps prevent false activation of the repeater by radar or spurious signals from other transmitters. This tone system, called “CTCSS” (Continuous Tone Coded Squelch System), is included in your **FT-60R**, and is very easy to activate.



*CTCSS setup involves two actions: setting the Tone Mode and then setting of the Tone Frequency. These actions are set up by using the [1(SQ TYP)] key and [2(CODE)] key.*

1. Press the **[F/W]** key, then press the **[1(SQ TYP)]** key to enable selection of the CTCSS/DCS mode.
2. Rotate the **DIAL** knob so that “TONE” indication appears on the display; this activates the CTCSS Encoder, for access to repeaters requiring a CTCSS tone.



3. Rotation of the **DIAL** knob one more “click” in step “2” above will cause the “TSQL” notation to appear. When “TSQL” is displayed, this means that the Tone SQuelch system is active, which mutes your **FT-60R**'s receiver until it receives a call from another radio sending out a matching CTCSS tone. This can help keep your radio quiet until a specific call is received, which may be helpful while operating in congested areas of the band.

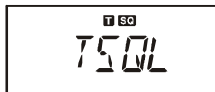

*1) You may notice a “REV TN” indication on the display while you rotate the DIAL knob in this step; this means that the Reverse Tone Squelch system is active, which mutes your FT-60R's receiver (instead of opening the squelch) when it receives a call from the radio sending a matched CTCSS tone. The “TSQ” icon will blink on the display when the Reverse Tone Squelch system is activated.*

*2) You may notice a “DCS” indication on the display while you rotate the DIAL knob still more. We'll discuss the Digital Code Squelch system shortly.*

4. When you have made your selection of the CTCSS tone mode, press the **PTT** switch to save the new setting.
5. Press the **[F/W]** key, then press the **[2(CODE)]** key to enable adjustment of the CTCSS frequency.
6. Rotate the **DIAL** knob until the display indicates the Tone Frequency you need to be using (ask the repeater owner/operator if you don't know the tone frequency).



| CTCSS TONE FREQUENCY (Hz) |       |       |       |       |       |
|---------------------------|-------|-------|-------|-------|-------|
| 67.0                      | 69.3  | 71.9  | 74.4  | 77.0  | 79.7  |
| 82.5                      | 85.4  | 88.5  | 91.5  | 94.8  | 97.4  |
| 100.0                     | 103.5 | 107.2 | 110.9 | 114.8 | 118.8 |
| 123.0                     | 127.3 | 131.8 | 136.5 | 141.3 | 146.2 |
| 151.4                     | 156.7 | 159.8 | 162.2 | 165.5 | 167.9 |
| 171.3                     | 173.8 | 177.3 | 179.9 | 183.5 | 186.2 |
| 189.9                     | 192.8 | 196.6 | 199.5 | 203.5 | 206.5 |
| 210.7                     | 218.1 | 225.7 | 229.1 | 233.6 | 241.8 |
| 250.3                     | 254.1 | —     | —     | —     | —     |



# CTCSS/DCS OPERATION

## CTCSS OPERATION

- When you have made your selection, press the [FW] key momentarily to save the new settings and exit to normal operation. This is different than the usual method of restoring normal operation, and it applies only to the configuration of the CTCSS/DCS frequencies.

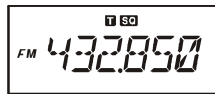

*Your repeater may or may not re-transmit a CTCSS tone - some systems just use CTCSS to control access to the repeater, but don't pass it along when transmitting. If the S-Meter deflects, but the FT-60R is not passing audio, repeat steps "1" through "4" above, but rotate the DIAL so that "TSQ" disappears - this will allow you to hear all traffic on the channel being utilized.*

## DCS OPERATION

Another form of tone access control is Digital Code Squelch, or DCS. It is a newer, more advanced tone system which generally provides more immunity from false paging than does CTCSS. The DCS Encoder/Decoder is built into your **FT-60R**, and operation is very similar to that just described for CTCSS. Your repeater system may be configured for DCS; if not, DCS is frequently quite useful in Simplex operation if your friend(s) use transceivers equipped with this advanced feature.

*Just as in CTCSS operation, DCS requires that you set the Tone Mode to DCS and that you select a tone code.*

- Press the [FW] key, then press the [1(SQ TYP)] key to enable selection of the CTCSS/DCS mode.
- Rotate the **DIAL** knob until the "DCS" indication appears on the display; this activates the DCS Encoder/Decoder.
- Press the **PTT** key to save the new setting.
- Press the [FW] key, then press the [2(CODE)] key to enable adjustment of the DCS code.

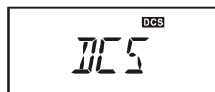

- Rotate the **DIAL** knob to select the desired DCS Code (a three-digit number). Ask the repeater owner/operator if you don't know DCS Code; if you are working simplex, just set up the DCS Code to be the same as that used by your friend(s).

| DCS CODE |     |     |     |     |     |     |     |     |     |
|----------|-----|-----|-----|-----|-----|-----|-----|-----|-----|
| 023      | 025 | 026 | 031 | 032 | 036 | 043 | 047 | 051 | 053 |
| 054      | 065 | 071 | 072 | 073 | 074 | 114 | 115 | 116 | 122 |
| 125      | 131 | 132 | 134 | 143 | 145 | 152 | 155 | 156 | 162 |
| 165      | 172 | 174 | 205 | 212 | 223 | 225 | 226 | 243 | 244 |
| 245      | 246 | 251 | 252 | 255 | 261 | 263 | 265 | 266 | 271 |
| 274      | 306 | 311 | 315 | 325 | 331 | 332 | 343 | 346 | 351 |
| 356      | 364 | 365 | 371 | 411 | 412 | 413 | 423 | 431 | 432 |
| 445      | 446 | 452 | 454 | 455 | 462 | 464 | 465 | 466 | 503 |
| 506      | 516 | 523 | 526 | 532 | 546 | 565 | 606 | 612 | 624 |
| 627      | 631 | 632 | 654 | 662 | 664 | 703 | 712 | 723 | 731 |
| 732      | 734 | 743 | 754 | -   | -   | -   | -   | -   | -   |

- When you have made your selection, press the [FW] key momentarily to save the new settings and exit to normal operation.

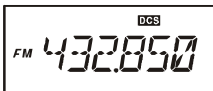

# CTCSS/DCS OPERATION

## DCS OPERATION



*Remember that the DCS is an Encode/Decode system, so your receiver will remain muted until a matching DCS code is received on an incoming transmission. Switch the DCS off when you're just tuning around the band!*

## TONE SEARCH SCANNING

In operating situations where you don't know the CTCSS or DCS tone being used by another station or stations, you can command the radio to listen to the incoming signal and scan in search of the tone being used. Two things must be remembered in this regard:

- You must be sure that your repeater uses the same tone type (CTCSS vs. DCS).
- Some repeaters do not pass the CTCSS tone; you may have to listen to the station(s) transmitting on the repeater uplink (input) frequency in order to allow Tone Search Scanning to work.

To scan for the tone in use:

1. Set the radio up for either CTCSS or DCS Decoder operation (see the previous discussions). In the case of CTCSS, “**T SQ**” will appear on the display; in the case of DCS, “**DCS**” will appear on the display.
2. Press the [F/W] key, then press the [2(CODE)] key.
3. Press and hold in the [▲(MHz)] or [▼(MHz)] key for one second to start scanning for the incoming CTCSS or DCS tone/code.
4. When the radio detects the correct tone or code, it will halt on that tone/code, and audio will be allowed to pass. Press the [F/W] key to lock in that tone/code, then press the [F/W] key again to exit to normal operation.

A digital display showing the frequency 100.017.

A digital display showing the code DCS.023.



*If the Tone Scan feature does not detect a tone or code, it will continue to scan indefinitely. When this happens, it may be that the other station is not sending any tone. You can press the PTT switch to halt the scan at any time.*

You also can press the **MONI** key during Tone Scanning to listen to the (muted) signal from the other station. When you release the **MONI** key, Tone Scanning will resume after about a second.

Tone Scanning works either in the VFO or Memory modes.

# CTCSS/DCS OPERATION

## CTCSS/DCS BELL OPERATION

During CTCSS Decode or DCS operation, you may set up the **FT-60R** such that a ringing “bell” sound alerts you to the fact that a call is coming in. Here is the procedure for activating the CTCSS/DCS Bell:

1. Set the transceiver up for CTCSS Decode (“Tone Squelch”) or DCS operation, as described previously.
2. Adjust the operating frequency to the desired channel.
3. Press the **[F/W]** key, then press the **[5(BELL)]** key.
4. Rotate the **DIAL** knob to set the desired number of rings of the Bell. The available choices are “1 T,” “3 T,” “5 T,” or “8 T” rings, “CONT” (continuous ringing), or “OFF.”
5. Press the **PTT** switch momentarily to save the new setting and exit to normal operation.

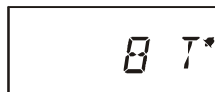

When you are called by a station whose transceiver is sending a CTCSS tone or DCS code which matches that set into your Decoder, the Bell will ring in accordance with this programming.

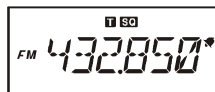

## SPLIT TONE OPERATION

The **FT-60R** can be operated in a Split Tone configuration via the Set mode.

1. Press the **[F/W]** key, then press the **[0(⊗)SET]** key to enter the Set mode.
2. Rotate the **DIAL** knob to select Set Mode Item 47: SPLIT.
3. Press the **[F/W]** key momentarily to enable adjustment of this Set Mode Item.
4. Rotate the **DIAL** knob to select ON (to enable the Split Tone feature).
5. Press the **PTT** key momentarily to save the new setting and exit to normal operation.

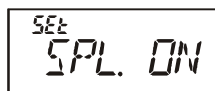
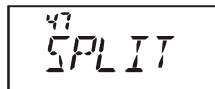

When the Split Tone feature is activated, you can see the following additional parameters following the “DCS” parameter (while selecting the tone mode by pressing **[F/W]** → **[1(SQ TYP)]**):

- D: DCS Encode only (the “**DCS**” icon will blink during operation)
- T DCS: Encodes a CTCSS Tone and Decodes a DCS code (the “**T**” icon will blink and the “**DCS**” icon will appear during operation)
- D TSQL: Encodes a DCS code and Decodes a CTCSS Tone (the “**T SQ**” icon will appear and the “**DCS**” icon will blink during operation)

Select the desired operating mode, from the selections shown above.

# CTCSS/DCS OPERATION

## TONE CALLING (1750 Hz)

If the repeaters in your country require a 1750-Hz burst tone for access (typically in Europe), you can set the **MONI** switch to serve as a “Tone Call” switch instead. To change the configuration of this switch, we again use the Set Mode to help us.

1. Press the [**F/W**] key, then press the [**0**()**SET**] key to enter the Set mode.
2. Rotate the **DIAL** knob to select Set Mode Item 26: M/T-CL.
3. Press the [**F/W**] key momentarily to enable adjustment of this Set Mode Item.
4. Rotate the **DIAL** knob to select “TCALL” on the display.
5. Press the **PTT** switch to save the new setting and exit to normal operation.

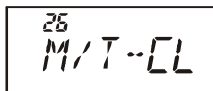

26  
M/T-CL

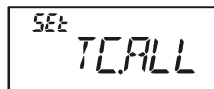

52  
TCALL

To access a repeater, press and hold in the **MONI** switch for the amount of time specified by the repeater owner/operator. The transmitter will automatically be activated, and a 1750-Hz audio tone will be superimposed on the carrier. Once access to the repeater has been gained, you may release the **MONI** switch, and use the **PTT** switch for activating the transmitter thereafter.

# MEMORY MODE

The **FT-60R** provides a wide variety of memory system resources. These include:

- 1000 “Standard” memory channels, numbered “000” through “999.”
- 5 “Home” channels, providing storage and quick recall of one prime frequency on each operating band.
- 50 sets of band-edge memories, also known as “Programmable Memory Scan” channels, labeled “L01/U01” through “L50/U50.”
- 10 Memory Banks, labeled “BANK 1” through “BANK 10.” Each Memory Bank can be assigned up to 1000 channels from the “standard” and “PMS” memory channels.
- 10 “Weather Broadcast” Channels.

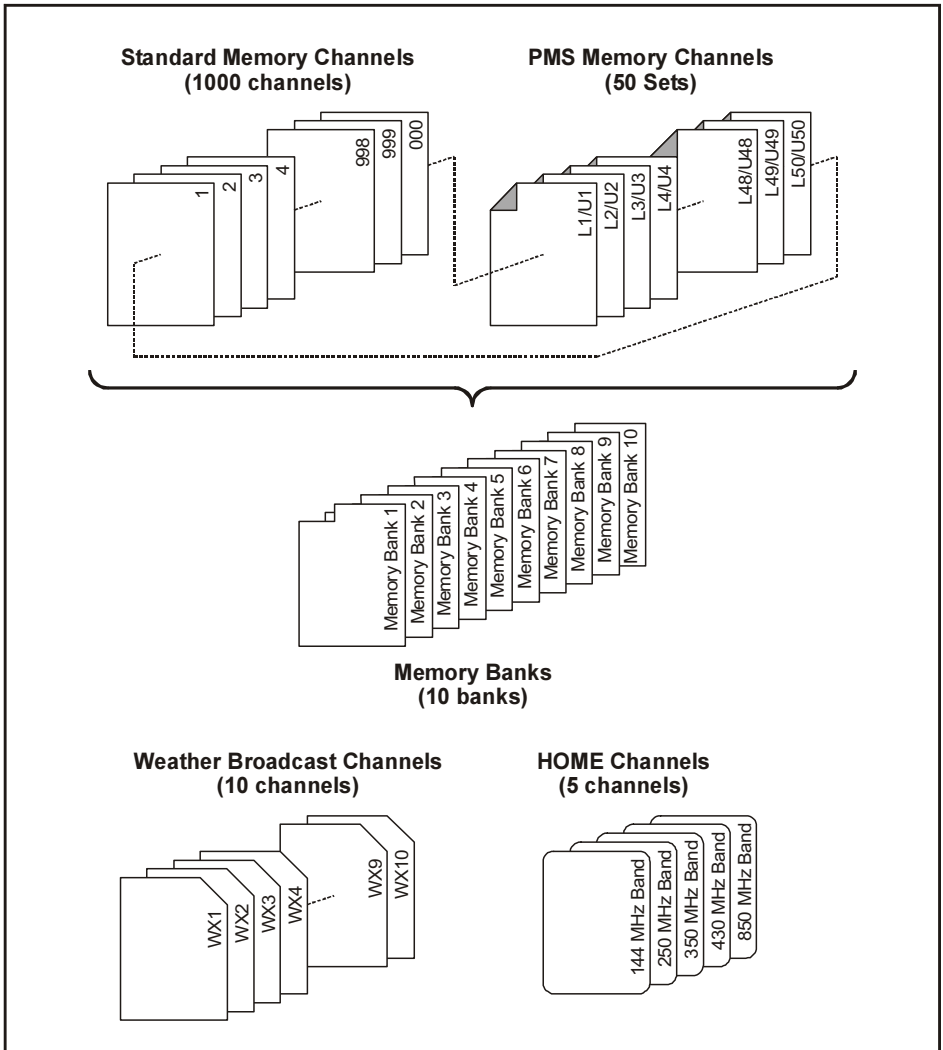

# MEMORY MODE

## MEMORY STORAGE

1. Select the desired frequency, while operating in the VFO mode. Be *sure* to set up any desired CTCSS or DCS tones, as well as any desired repeater offset. The power level may also be set at this time, if you wish to store it.
2. Press and hold in the **[F/W]** key for one second.
3. Within ten seconds of releasing the **[F/W]** key, you need to make a decision regarding channel storage. The microprocessor will automatically select the next-available “free” channel (a memory register on which no data has been stored), so you may not wish to make any change; if this is the case, proceed to step 4. If you wish to select a different channel number into which to store the data, rotate the **DIAL** knob to select the desired memory channel. You may jump 100 memory channels, if you’re in a hurry (101 → 201 → 301 …) by pressing the **[BAND(BAND DN)]** key (multiple times, if necessary).
4. Press the **[F/W]** key once more to store the frequency into memory.
5. You still will be operating in the “VFO” mode, so you may now enter other frequencies, and store them into additional memory locations, by repeating the above process.

### Storing Independent Transmit Frequencies (“Odd Splits”)

All memories can store an independent transmit frequency, for operation on repeaters with non-standard shift. To do this:

1. Store the receive frequency using the method already described under **MEMORY STORAGE** (it doesn’t matter if a repeater offset is active).
2. Turn to the desired transmit frequency, then press and hold in the **[F/W]** key for one second.
3. Within five seconds of releasing the **[F/W]** key, rotate the **DIAL** knob to select the same memory channel number as used in step “1” above.
4. Press and hold in the **PTT** switch, then press the **[F/W]** key once more momentarily while holding the **PTT** switch in (this does not key the transmitter).



*Whenever you recall a memory which contains independently-stored transmit and receive frequencies, the “**FM**” indication will appear in the display.*

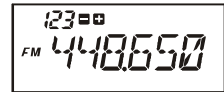

## MEMORY RECALL

1. While operating in the VFO mode, press the [V/M(PRI)] key to enter the Memory mode.
2. Rotate the **DIAL** knob to select the desired channel.
3. To return to the VFO mode, press the [V/M(PRI)] key.



When the radio is already set to the Memory mode, an easy way to recall memories is to key in the memory channel number, then press the [F/W] key.

*For example*, to recall memory channel #14, press [1] → [4] → [F/W].

You may also recall the Memory Channel #000 and Programmable Memory channels (“L01/U01” through “L50/U50.”) using the following numbers: Memory Channel #000 = “1000,” Programmable Memory channels #L1 = “1001,” U1 = “1002,” L50 = “1099,” and U50 = “1100.”

## HOME CHANNEL MEMORY

A special one-touch “HOME” channel is available for each of operating bands, to allow quick recall of a favorite operating frequency on each band.

Home Channel storage is simple to accomplish:

1. Change the setting of Set Mode Item 36: REV/HM from “REV” to “HOME,” if it is not already set to this option (see page 75).
2. Select the desired frequency, while operating in the VFO mode. Be sure to set up any desired CTCSS or DCS tones, as well as any desired repeater offset. The power level may also be set at this time, if you wish to store it.
3. Press and hold in the [F/W] key for one second.
4. While the memory channel number is blinking, just press the [HM/RV] key. The frequency and other data (if any) will now be stored in the special HOME channel register.
5. You may repeat this process on the other operating bands.
6. To recall the HOME channel, press the [HM/RV] key momentarily while operating either in the VFO or MR mode.

**DEFAULT HOME CHANNELS**

| BAND         | FREQUENCY   |
|--------------|-------------|
| 144 MHz Band | 146.520 MHz |
| 250 MHz Band | 250.000 MHz |
| 350 MHz Band | 350.000 MHz |
| 430 MHz Band | 446.000 MHz |
| 850 MHz Band | 850.000 MHz |

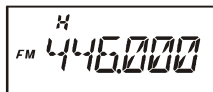

*The UHF HOME channel is the one used during “Emergency channel operation.” See page 46 for details regarding this feature.*

# MEMORY MODE

## LABELING MEMORIES

You may wish to append an alpha-numeric “Tag” (label) to a memory or memories, to aid in recollection of the channel’s use (such as a club name, etc.). This is easily accomplished using the Set Mode.

1. Recall the memory channel on which you wish to append a label.
2. Press the **[F/W]** key, then press the **[0(⊗)SET]** key to enter the Set mode.
3. Rotate the **DIAL** knob to select Set Mode Item 28: NM WRT.
4. Press the **[F/W]** key momentarily to display the previously stored label (if any).
5. Press the **[F/W]** key again to clear any previous label.
6. Rotate the **DIAL** knob to select the first digit of the desired label.
7. Press the **[F/W]** key to move to the next character.
8. If you make a mistake, press the **[▼(MHz)]** key to back-space the cursor, then re-enter the correct letter, number, or symbol.
9. Repeat steps 5 through 7 to program the remaining letters, numbers, or symbols of the desired label. A total of six characters may be used in the creation of a label.
10. When you have programmed a label which is under 6 characters, press and hold in the **[F/W]** key for one second to confirm the label (if the label is exactly 6 characters in length, you do not need to press and hold in **[F/W]**).
11. When you have completed the creation of the label, press the **PTT** key to save the label and exit.

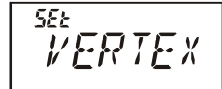
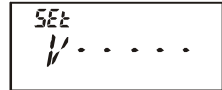
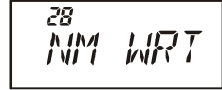

### To display the alpha-numeric “Tag” (label):

1. Set the **FT-60R** to the “MR” (Memory Recall) mode, and recall the memory channel on which you wish to display its label.
2. Press the **[F/W]** key, then press the **[0(⊗)SET]** key to enter the Set mode.
3. Rotate the **DIAL** knob to select the Set Mode Item labeled 27: NAME.
4. Press the **[F/W]** key momentarily to enable adjustment of this Item’s setting.
5. Rotate the **DIAL** knob to set this Set Mode Item to “ALPHA” (thus enabling the alpha-numeric display).
6. Press the **PTT** key to save the new setting and activate the alpha-numeric Tag.

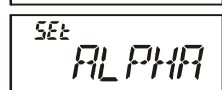
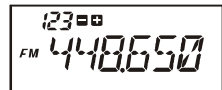



## LABELING MEMORIES

To disable the alpha-numeric Tag (enabling the frequency display), just repeat the above procedure, rotating the **DIAL** knob to select “FREQ” in step 5 above.



*You may set up some memory channels to have their frequencies displayed, while others may be set to have their Name Tag displayed; the selection within Set Mode Item 27 is not applied to all memory channels at once (just the channel on which you currently are operating).*

## MEMORY OFFSET TUNING

Once you have recalled a particular memory channel, you may easily tune off that channel, as though you were in the “VFO” mode.

1. With the **FT-60R** in the “MR” (Memory Recall) mode, select the desired memory channel.
2. Press the [**BAND(BAND DN)**] key momentarily to activate the “Memory Tuning” feature. The Memory Channel number will be replaced by “tun.” And if you have an alpha-numeric Tag displayed on the memory channel, the display will automatically revert to display of the operating frequency, so you can navigate without having to enter the Menu to change the display configuration.
3. Rotate the **DIAL** knob, as desired, to tune to a new frequency. The synthesizer steps selected for VFO operation on the current band will be the steps used during Memory Tuning.
4. If you wish to return to the original memory frequency, just press the [**BAND(BAND DN)**] key momentarily. The display will revert to display of the alpha-numeric Tag (if any) that may have originally appeared on the LCD.
5. If you wish to store a new frequency set during Memory Tuning, just press and hold in the [**F/W**] key for one second, per normal memory storage procedure. The microprocessor will automatically set itself to the next-available clear memory location, and you then press [**F/W**] again to lock in the new frequency.



- 1) *If you want to replace the original memory contents with those of the new frequency, be sure to rotate the **DIAL** knob to the original memory channel number!*
- 2) *Any required **CTCSS/DCS** changes, or repeater offset modifications, must be done before storing the data into the new (or original) memory channel location.*

# MEMORY MODE

---

## DELETING MEMORIES

---

You may desire to delete the memories (except the Memory Channel “1” and Home Channel). The procedure for deleting a channel is quite simple.

1. Press the [**VM(PRI)**] key, if needed, to enter the MR mode.
2. Press and hold in the [**F/W**] key for one second, then rotate the DIAL knob to select the memory channel to be “deleted.”
3. Press the [**HM/RV**] key momentarily. The display will revert to memory channel #1. The previously-selected memory will be deleted.

***Important Notice! Once deleted, the channel data cannot be recovered!***

---

## MOVING MEMORY DATA TO THE VFO

---

Data stored on memory channels can easily be moved to the VFO, if you like.

1. Select the memory channel containing the frequency data to be moved to the VFO.
2. Press the [**BAND(BAND DN)**] key momentarily to activate the “Memory Tune” feature temporarily, then press and hold in the [**BAND(BAND DN)**] key for one second. The data will now have been copied to the VFO, although the original memory contents will remain intact on the previously-stored channel.



***If a Split Frequency Memory channel was transferred, the TX frequency will be ignored (you will be set up for Simplex operation on the Receive frequency).***

## MEMORY BANK OPERATION

The large number of memories available in the **FT-60R** could be difficult to utilize without some means of organizing them. Fortunately, the **FT-60R** includes provision for dividing the memories into as many as ten Memory Groups, so you can categorize the memories in a manner convenient to you. You may enter and exit the “Memory Group” mode by a single press of the [**BAND(BAND DN)**] key, as we shall see below.

### Assigning Memories to a Memory Bank

1. Recall the memory channel to be assigned to a Memory Bank.
2. Press and hold in the [**BAND(BAND DN)**] key for one second, then rotate the **DIAL** knob to select the Memory Bank number you want as the Memory Bank for this channel (“BANK 1” ~ “BANK10”).
3. Press and hold in the [**F/W**] key for one second to copy the memory channel data into the Memory Bank.

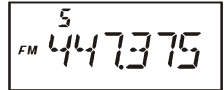

*1) You may assign one memory channel into several Memory Banks.*

*2) The PMS memory channels (L1/U1 through L50/U50) may not be assigned to a Memory Bank.*

| Memory Channel |             |
|----------------|-------------|
| CH 000         | 145.000 MHz |
| CH 001         | 145.500 MHz |
| CH 002         | 435.000 MHz |
| CH 003         | 435.500 MHz |
| CH 004         | 145.800 MHz |
| CH 005         | 436.000 MHz |
| CH 006         | 128.800 MHz |
|                |             |
| CH 997         | 145.620 MHz |
| CH 998         | 436.780 MHz |
| CH 999         | 128.800 MHz |



### Memory Bank Recall

1. Press the [**V/M(PRI)**] key, if needed, to enter the Memory mode.
2. Press and hold in the [**BAND(BAND DN)**] key, then rotate the **DIAL** knob to select the desired Memory Bank (“BANK 1” through “BANK10”).
3. Press the [**V/M(PRI)**] key momentarily; now, as you rotate the **DIAL** knob to select memories, you will observe that you can only select memory channels in the current memory bank. The “**BANK**” indication will appear at the left side of the frequency display while operating within a Memory Bank.
4. To change to another Memory Bank, press and hold in the [**BAND(BAND DN)**] key, rotate the **DIAL** knob to select the new Memory Bank, then press the [**V/M(PRI)**] key momentarily.
5. To exit from Memory Bank operation, select “**NOBANK**” in step 4 above. You are now in the “standard” Memory Recall mode, without utilization of the Memory Banks. The memories stored in the various Banks will remain in those banks, however; you do not need to store them again.

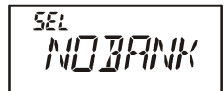
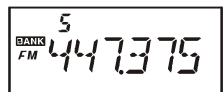
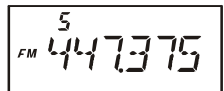

# MEMORY MODE

## MEMORY BANK OPERATION

### Removing Memories from a Memory Bank

1. Recall the memory channel to be removed from a Memory Bank.
2. Press and hold in the [BAND(BAND DN)] key for one second, then press and hold in the [F/W] key for one second to remove the memory channel data from the Memory Bank.

## MEMORY ONLY MODE

Once memory channel programming has been completed, you may place the radio in a “Memory Only” mode, whereby VFO operation is impossible. This may be particularly useful during public-service events, where a number of operators may be using the radio for first time, and ultimate simplicity of channel selection is desired.

To place the radio into the Memory Only mode:

1. Turn the radio off.
2. Press and hold in the **MONI** switch (just below the **PTT** switch) while turning the radio on.
3. Rotate the **DIAL** knob to select the “F5 M-ONLY” option, then press the [F/W] key.



F1  
SETRST



F5  
M-ONLY

To return to normal operation, repeat the above power-on procedure.

## WEATHER BROADCAST CHANNELS (U. S. VERSION)

The VHF Weather Broadcast Station Memory Channel Bank has been pre-programmed at the factory, for quick selection of NOAA weather information stations.

1. Press and hold in the [1(SQ TYP)] key for one second to recall the Weather Broadcast Memory Bank.
2. Rotate the **DIAL** knob to select the desired Weather Broadcast channel.
3. If you wish to scan this bank to search for louder stations, just press the **PTT** switch. When the scanner pauses on a station, press the **PTT** key once to halt the scan, or press it twice to restart the scan.
4. To exit to normal operation, press the [V/M(PRI)] key, or press and hold in the [1(SQ TYP)] key again.

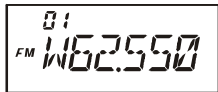

01  
FM 162.550

| CH | FREQUENCY   | CH | FREQUENCY   |
|----|-------------|----|-------------|
| 01 | 162.550 MHz | 06 | 162.500 MHz |
| 02 | 165.400 MHz | 07 | 165.525 MHz |
| 03 | 162.475 MHz | 08 | 161.650 MHz |
| 04 | 162.425 MHz | 09 | 161.775 MHz |
| 05 | 162.450 MHz | 10 | 163.275 MHz |

### Severe Weather Alert

In the event of extreme weather disturbances, such as severe thunderstorms and hurricanes, the NOAA (National Oceanic and Atmospheric Administration) sends a weather alert accompanied by a 1050 Hz tone and subsequent weather report on one of the NOAA weather channels. See page 39 for details regarding activation of this mode.

The **FT-60R** allows you to scan just the memory channels, the entire operating band, or a portion of that band. It will halt on signals encountered, so you can talk to the station(s) on that frequency, if you like.

Scanning operation is basically the same in each of the above modes. Before you begin, take a moment to select the way in which you would like the scanner to resume scanning after it halts on a signal.

## Setting the Scan-Resume Technique

Three options for the Scan-Resume mode are available:

**BUSY:** In this mode, the scanner will halt on a signal it encounters. One second after the carrier has dropped because the other station(s) ceased transmission, the scanner will resume. In the case of constant-carrier signals like Weather Station broadcasts, the scanner will likely remain on this frequency indefinitely.

**HOLD:** In this mode, the scanner will halt on a signal it encounters. It will not restart automatically; you must manually re-initiate scanning if you wish to resume.

**TIME:** In this mode, the scanner will halt on a signal it encounters, and will hold there for five seconds. If you do not take action to disable the scanner within that time period, the scanner will resume even if the stations are still active.

To set the Scan-Resume mode:

1. Press the **[F/W]** key, then press the **[0(∅)SET]** key to enter the Set mode.
2. Rotate the **DIAL** knob to select Set Mode Item 35: RESUME.
3. Press the **[F/W]** key momentarily to enable adjustment of this Set Mode Item.
4. Rotate the **DIAL** knob to select the desired scan-resume mode.
5. When you have made your selection, press the **PTT** key to save the new setting and exit to normal operation.

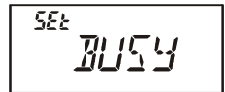
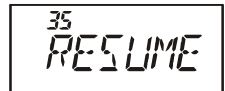

*The default condition for this Set Mode Item is “BUSY.”*

---



---

## VFO SCANNING

---

The **FT-60R** provides two VFO scanning functions: “Manual VFO Scanning” and “Programmed VFO Scanning.”

### Manual VFO Scan

1. Select the VFO mode by pressing the **[V/M(PRI)]** key, if necessary.
2. Press and hold in either the **[▲(MHz)]** or **[▼(MHz)]** key for one second to initiate upward or downward scanning, respectively.
3. If and when the scanner encounters a signal strong enough to open the squelch, the scanner will halt temporarily; the decimal point of the frequency display will blink during this “Pause” condition.

## VFO SCANNING

4. The scanner will then resume according to the Scan-Resume mode selected in the previous section.
5. To cancel scanning, press the **PTT** switch or **[V/M(PRI)]** key.

### Programmed VFO Scan

1. Select the VFO mode by pressing the **[V/M(PRI)]** key, if necessary.
2. Press and hold in the **[BAND(BAND DN)]** key for one second, then rotate the **DIAL** knob to select the bandwidth for the Programmed VFO scanner. Available selections are  $\pm 1$  MHz,  $\pm 2$  MHz,  $\pm 5$  MHz, ALL, PMS-X, and BAND.



ALL: The scanner will sweep all frequencies.

PMS-X: The scanner will sweep frequencies within the currently-selected PMS frequency pair. See page 40 for details.

BAND: The scanner will sweep frequencies only on the current band.

3. Press the **[BAND(BAND DN)]** key momentarily to save the new setting and exit to normal operation.
4. Press and hold in the **[V/M(PRI)]** key for one second to start scanning.
5. If and when the scanner encounters a signal strong enough to open the squelch, the scanner will halt temporarily; the decimal point of the frequency display will blink during this "Pause" condition.
6. The scanner will then resume according to the Scan-Resume mode selected in the previous section.
7. To cancel scanning, press the **PTT** switch or **[V/M(PRI)]** key.

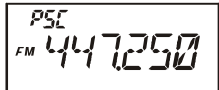

*1) When you start the Programmed VFO Scanner, the FT-60R will be changing frequency in the upward direction. If you want to change direction of the scan while it is underway, rotate the DIAL knob one click in the opposite direction (in this case, one click counter-clockwise). You'll see the scanner turn around and change frequency downward!*

*2) You may change the scanner's method of operation so that the VFO frequency will jump to the low band edge of the next band when the VFO frequency reaches the high edge of the current band (or vice versa). See page 78 regarding Set Mode Item 54: VFO .BND.*

## MEMORY SCANNING

Memory scanning is similarly easy to initiate:

1. Select the Memory mode by pressing the [V/M(PRI)] key, if necessary.
2. Press and hold in either the [▲(MHz)] or [▼(MHz)] key for one second to initiate upward or downward scanning, respectively.
3. If and when the scanner encounters a signal strong enough to open the squelch, the scanner will halt temporarily; the decimal point of the frequency display will blink during this “Pause” condition.
4. The scanner will then resume according to the Scan-Resume mode selected in the previous section.
5. To cancel scanning, press the PTT switch or [V/M(PRI)] key.

### How to Skip (Omit) a Channel during Memory Scan Operation

As mentioned previously, some continuous-carrier stations like a Weather Broadcast station will seriously impede scanner operation if you are using the “Carrier Drop” Scan-Resume mode, as the incoming signal will not pause long enough for the transceiver to resume scanning. Such channels may be “Skipped” during scanning, if you like:

1. Recall the Memory Channel to be skipped during scanning.
2. Press the [F/W] key, then press the [0(⊗)SET] key to enter the Set mode.
3. Rotate the **DIAL** knob to select Set Mode Item 46: SKIP.
4. Press the [F/W] key momentarily to enable adjustment of this Set Mode Item.
5. Rotate the **DIAL** knob so as to select “SKIP.” The current Memory Channel will now be ignored during scanning. The “ONLY” selection is used for “Preferential Memory Scan,” described in the next section.
6. When you have made your selection, press the PTT key to save the setting and exit to normal operation.

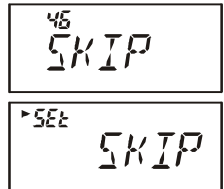

When you recall the “skipped” memory channel manually, a small “▶” icon will appear at the left of the memory channel number, indicating it is to be ignored during scanning.

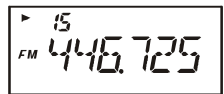

To re-institute a channel into the scanning loop, select “OFF” in step 5 above (the “Skipped” channel will, of course, still be accessible via manual channel selection methods using the **DIAL** knob in the MR mode, whether or not it is locked out of the scanning loop).



*In the factory default configuration, you may recall Set Mode Item 46: SKIP by pressing [F/W] → [8(P2)].*

## MEMORY SCANNING

### Preferential Memory Scan

The **FT-60R** also allows you to set up a “Preferential Scan List” of channels which you can “flag” within the memory system. These channels are designated by a blinking “▶” icon when you have selected them, one by one, for the Preferential Scan List.

Here is the procedure for setting up and using the Preferential Scan List:

1. Recall the Memory Channel which you wish to add to the Preferential Scan List.
2. Press the **[F/W]** key, then press the **[0(⊗)SET]** key to enter the Set mode.
3. Rotate the **DIAL** knob to select Set Mode Item 46: SKIP.
4. Press the **[F/W]** key momentarily to enable adjustment of this Set Mode Item.
5. Rotate the **DIAL** knob so as to select “ONLY.”
6. When you have made your selection, press the **PTT** key to save the settings and exit to normal operation.
7. To remove a channel from the Preferential Scan List, just repeat the above procedure, rotating the **DIAL** knob to select “OFF” in step 5 above.

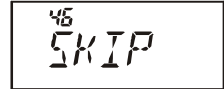

46  
SKIP



▶SET  
ONLY

*In the factory default configuration, you may recall Set Mode Item 46: SKIP by pressing [F/W] → [8(P2)].*

To initiate Preferential Memory Scan:

1. Press the **[F/W]** key, then press the **[0(⊗)SET]** key to enter the Set mode.
2. Rotate the **DIAL** knob to select Set Mode Item 43: SCN MD.
3. Press the **[F/W]** key momentarily to enable adjustment of this Set Mode Item.
4. Rotate the **DIAL** knob so as to select “ONLY.”
5. Press the **PTT** key to save the settings and exit to normal operation.
6. Now, press and hold in either the **[▲(MHz)]** or **[▼(MHz)]** key for one second to initiate the Preferential Memory Scan. Only the channels which have the blinking “▶” icon appended to the channel number will be scanned.
7. To cancel the Preferential Memory Scan, just repeat the above procedure, rotating the **DIAL** knob to select “MEM” in step 4 above.



43  
SCN MD



SET  
ONLY



## MEMORY SCANNING

### Memory Bank Scan

When the Memory Bank feature is engaged, the scanner sweeps only memory channels in the current Memory Bank. However, if the Memory Bank Link Scan feature is enabled, you may sweep the memory channels in several Memory Banks which you have selected.

To enable the Memory Bank Link Scan feature:

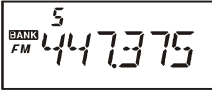

1. Set the radio to the Memory mode by pressing the **[V/M(PRI)]** key, if necessary.
2. Press and hold in the **[BAND(BAND DN)]** key for one second, then rotate the **DIAL** knob to select the first Memory Bank (“BANK 1” ~ “BANK10”) you wish to sweep using Memory Bank Link Scan.
3. Press the **[FW]** key momentarily. The current Memory Bank will now be swept during Memory Bank Scan. A “decimal point” will be appended between the “N” and “K” of the Memory Bank number indication (such as BAN.K 2). 
4. Repeat steps 2 and 3 above, to append the “decimal point” to any other Memory Banks you wish to sweep.
5. Now, press and hold in the **[V/M(PRI)]** key for one second to initiate the Memory Bank Link Scan. 
6. To remove a Memory Bank from the Memory Bank Link Scan, repeat steps 2 and 3 above, to delete the “decimal point” from the Memory Bank number indication.

## WEATHER ALERT SCAN

This feature allows you to check the Weather Broadcast Memory Channels for the presence of the NOAA Alert Tone while operating using VFO scan or Memory channel scan.

When the Weather Alert Scan feature is engaged, the **FT-60R** will check the Weather Broadcast Memory Channels for activity every five seconds while scanning. If you watch the display carefully, you'll observe the scanner periodically shifting to the Weather Broadcast bank, scanning the Weather channels quickly in search of the Alert Tone, after which regular scanning will resume for another five seconds.

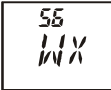
To enable the Weather Alert Scan feature:

1. Press the **[FW]** key, then press the **[0(⊗)SET]** key to enter the Set mode.
2. Rotate the **DIAL** knob to select Set Mode Item 56: WX ALT. 
3. Press the **[FW]** key momentarily to enable adjustment of this Set Mode Item.
4. Rotate the **DIAL** knob so as to select “ALT. ON.” 
5. When you have made your selection, press the **PTT** key to save the setting and exit to normal operation.
6. To disable the Weather Alert Scan feature, select “ALT.OFF” in step 4 above.

---

## WEATHER ALERT SCAN

---



1) When the Weather Alert Scan feature is engaged, the Scan-Resume mode is fixed to “TIME.”

2) If you are just scanning the Weather Broadcast Channels, the FT-60R's receiver will remain muted indefinitely unless the Alert Tone is received. This yields a long period of monitoring time, as no power will be consumed via audio output while scanning for the Alert Tone is in progress.

---

## PROGRAMMABLE (BAND LIMIT) MEMORY SCAN (PMS)

---

This feature allows you to set sub-band limits for either scanning or manual VFO operation. For example, you might wish to set up a limit (in North America) of 144.300 MHz to 148.000 MHz so as to prevent encroachment into the SSB/CW “Weak Signal” portion of the band below 144.300 MHz. Here's how to do this:

1. Set the radio to the VFO mode by pressing the [V/M(PRI)] key, if necessary.
2. Using the techniques learned earlier, store (per the above concept) 144.300 MHz into Memory Channel #L01 (the “L” designates the Lower sub-band limit).
3. Likewise, store 148.000 MHz into Memory Channel #U01 (the “U” designates the Upper sub-band limit).
4. Confirm the radio is in the VFO mode, press and hold in the [BAND(BAND DN)] key for one second, and rotate the **DIAL** knob to select the desired PMS frequency pair (PMSxx), then press the [BAND(BAND DN)] key.
5. Now, press and hold in the [V/M(PRI)] key for one second to initiate the Programmable (Band Limit) Memory Scan; the Memory Channel number will be replaced by “Pxx.” Scanning and tuning will now be limited within the just-programmed range.
6. 50 pairs of Band Limit memories, labeled L01/U01 through L50/U50 are available. You therefore can set upper and lower operation limits in multiple segments on a number of bands, if you like.

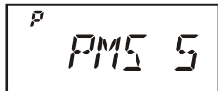

## “PRIORITY CHANNEL” SCANNING (DUAL WATCH)

The **FT-60R**'s scanning features include a two-channel scanning capability which allows you to operate on a VFO or Memory channel, while periodically checking a user-defined Memory Channel for activity. If a station is received on the Memory Channel which is strong enough to open the Squelch, the scanner will pause on that station in accordance with the Scan-Resume mode set via Set Mode Item 35: RESUME. See page 35.

Here is the procedure for activating Priority Channel Dual Watch operation:

### VFO Priority

1. Recall the memory channel you wish to use as the “Priority” frequency.
2. Now, set the radio to the VFO mode by pressing the **[V/M(PRI)]** key.
3. Press the **[F/W]** key, then press the **[V/M(PRI)]** key to activate the VFO Priority mode. The display will remain on the VFO frequency, but every five seconds the radio will check the Priority Channel (memory channel) for activity.
4. Press **[F/W] → [V/M(PRI)]** again to disable the VFO Priority mode.

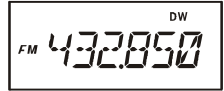

### Memory Channel Priority

1. Store the frequency you wish to be the “Priority” Channel into memory channel “1.”
2. Now, set the radio for operation on another memory channel.
3. Press the **[F/W]** key, then press the **[V/M(PRI)]** key to activate the Memory Priority mode. The display will remain on the current memory channel frequency, but every five seconds the radio will check the Priority Channel (memory channel “1”) for activity.
4. Press **[F/W] → [V/M(PRI)]** again to disable the Memory Priority mode.

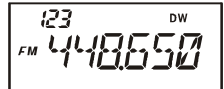

*When the Memory Bank feature is activated, the FT-60R will check the lowest memory channel in the current Memory Bank as the priority channel.*

### HOME Channel Priority

1. Recall the memory channel you wish to use as the “Priority” frequency.
2. Now set the radio for operation on a HOME channel by pressing the **[F/W]** key followed by **[HM/RV]**.
3. Press the **[F/W]** key, then press the **[V/M(PRI)]** key to activate the HOME Priority mode. The display will remain on the HOME channel frequency, but every five seconds the radio will check the Priority Channel (memory channel) for activity.
4. Press **[F/W] → [V/M(PRI)]** again to disable the HOME Priority mode.

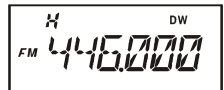

## “PRIORITY CHANNEL” SCANNING (DUAL WATCH)

### WX Channel Priority

1. Recall the memory channel you wish to use as the “Priority” frequency.
2. Now, set the radio for operation on a WX channel by pressing and holding in the [1(SQ TYP)] key for one second.
3. Press the [F/W] key, then press the [V/M(PRI)] key to activate the WX Priority mode. The display will remain on the WX channel frequency, but every five seconds the radio will check the Priority Channel (memory channel) for activity.
4. Press [F/W] → [V/M(PRI)] again to disable the WX Priority mode.



### Priority Revert Mode

During Priority channel operation (Dual Watch), a special feature is available which will allow you to move to the Priority channel instantly, without waiting for activity to appear on the Priority channel.

When this feature is enabled, and Priority monitoring is engaged, just press the **PTT** switch; operation will instantly revert to the Priority channel.

To enable the Priority Revert operation:

1. Press the [F/W] key, then press the [0(⊗)SET] key to enter the Set mode.

2. Rotate the **DIAL** knob to select Set Mode Item 39: PRI.RVT.



3. Press the [F/W] key momentarily to enable adjustment of this Set Mode Item.

4. Rotate the **DIAL** knob to set this Set Mode Item to “RVT. ON.”



5. When you have made your selection, press the **PTT** key to save the setting and exit to normal operation.
6. To disable the Priority Revert operation, just repeat the above procedure, rotating the **DIAL** knob to select “RVT.OFF” in step 4 above.

---

## AUTOMATIC LAMP ILLUMINATION ON SCAN STOP

---

The **FT-60R** will automatically illuminate the LCD/Keypad Lamp whenever the scanner stops on a signal; this allows you to see the frequency of the incoming signal better at night. Note that this will, of course, increase the battery consumption, so be sure to switch it off during the day (the default condition for this feature is “ON”).

The procedure for disabling the Scan Lamp is:

1. Press the **[F/W]** key, then press the **[0(⊗)SET]** key to enter the Set mode.
2. Rotate the **DIAL** knob to select Set Mode Item 44: SCN.LMP.
3. Press the **[F/W]** key momentarily to enable adjustment of this Set Mode Item.
4. Rotate the **DIAL** knob to set this Set Mode Item to “OFF.”
5. When you have made your selection, press the **PTT** key to save the setting and exit to normal operation.



---

## BAND EDGE BEEPER

---

The **FT-60R** will automatically “beep” when a band edge is encountered during scanning (either in standard VFO scanning or during PMS operation). You may also enable this feature (band edge beeper) to operate when the frequency reaches the band edge while tuning using the **DIAL** knob.

The procedure for enabling the Band-Edge Beeper is:

1. Press the **[F/W]** key, then press the **[0(⊗)SET]** key to enter the Set mode.
2. Rotate the **DIAL** knob to select Set Mode Item 19: EDG.BEP.
3. Press the **[F/W]** key momentarily to enable adjustment of this Set Mode Item.
4. Rotate the **DIAL** knob to set this Set Mode Item to “BEP. ON.”
5. When you have made your selection, press the **PTT** key to save the setting and exit to normal operation.

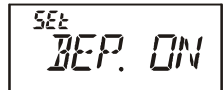

# EPCS (ENHANCED PAGING & CODE SQUELCH)

The **FT-60R** includes an Enhanced CTCSS tone encoder/decoder and a dedicated micro-processor providing paging and selective calling feature. This allows you to place a call to a specific station (Paging), and to receive calls of your choice directed only to you (Code Squelch).

The paging and code squelch systems use two pairs of (alternately switched) CTCSS tones which are stored in the pager memories. Basically, your receiver remains silent until it receives the CTCSS tone pair that matches those stored in the Receiving Pager Memory. The squelch then opens so the caller is heard, and the paging ringer immediately sounds, if activated. When you close the **PTT** switch to transmit, the CTCSS tone pair which is stored in the Transmitting Pager Memory will be transmitted automatically.

On the paged radio, the squelch will close automatically after the incoming page ends. Meanwhile, on the paging radio, the Enhanced Paging and Code Squelch system will be disabled after the **PTT** switch is released after the paging transmission. You may re-activate the Enhanced Paging and Code Squelch system again using Set Mode Item 29: PAGER, if desired.

## Storing the CTCSS Tone Pairs for EPCS Operation

1. Press the **[F/W]** key, then press the **[0(⊗)SET]** key to enter the Set mode.
2. Rotate the **DIAL** knob to select Set Mode Item 31: PAG.CDR for the Receiving CTCSS Tone Pair or Set Mode Item 32: PAG.CDT for the Transmitting CTCSS Tone Pair.
3. Press the **[F/W]** key momentarily to enable adjustment of this Set Mode Item.
4. Rotate the **DIAL** knob to set the CTCSS Tone number which corresponds to the first tone of the CTCSS Tone Pair.
5. Press the **[▲(MHz)]** or **[▼(MHz)]** key, then rotate the **DIAL** knob to set the CTCSS Tone number which corresponds to the second tone of the CTCSS Tone Pair.
6. Press the **PTT** switch to save the new setting and exit to normal operation.

31  
PAG.CDR

32  
PAG.CDT

SET  
\*07 47

SET  
07\*43

**CTCSS TONE NUMBER**

| No. | Hz   | No. | Hz    | No. | Hz    | No. | Hz    | No. | Hz    |
|-----|------|-----|-------|-----|-------|-----|-------|-----|-------|
| 01  | 67.0 | 11  | 94.8  | 21  | 131.8 | 31  | 171.3 | 41  | 203.5 |
| 02  | 69.3 | 12  | 97.4  | 22  | 136.5 | 32  | 173.8 | 42  | 206.5 |
| 03  | 71.9 | 13  | 100.0 | 23  | 141.3 | 33  | 177.3 | 43  | 210.7 |
| 04  | 74.4 | 14  | 103.5 | 24  | 146.2 | 34  | 179.9 | 44  | 218.1 |
| 05  | 77.0 | 15  | 107.2 | 25  | 151.4 | 35  | 183.5 | 45  | 225.7 |
| 06  | 79.7 | 16  | 110.9 | 26  | 156.7 | 36  | 186.2 | 46  | 229.1 |
| 07  | 82.5 | 17  | 114.8 | 27  | 159.8 | 37  | 189.9 | 47  | 233.6 |
| 08  | 85.4 | 18  | 118.8 | 28  | 162.2 | 38  | 192.8 | 48  | 241.8 |
| 09  | 88.5 | 19  | 123.0 | 29  | 165.5 | 39  | 196.6 | 49  | 250.3 |
| 10  | 91.5 | 20  | 127.3 | 30  | 167.9 | 40  | 199.5 | 50  | 254.1 |



*The FT-60R does not recognize the order of the 1st tone and the 2nd tone. In other words, for example, the FT-60R considers both CTCSS pairs "10, 35" and "35, 10" to be identical.*

# EPCS (ENHANCED PAGING & CODE SQUELCH)

## Activating the Enhanced Paging & Code Squelch System

1. Press the **[F/W]** key, then press the **[0(⊗)SET]** key to enter the Set mode.
2. Rotate the **DIAL** knob to select Set Mode Item 29: PAGER.
3. Press the **[F/W]** key momentarily to enable adjustment of this Set Mode Item.
4. Rotate the **DIAL** knob to select PAG. ON.
5. Press the **PTT** switch to save the new setting and activate the Enhanced Paging & Code Squelch.
6. To disable the Enhanced Paging & Code Squelch, just repeat the above procedure, rotating the **DIAL** knob to select “PAG.OFF” in step 4 above.

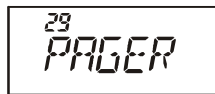

29  
PAGER

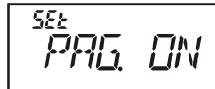

SET  
PAG. ON



*1) In the factory default configuration, you may recall Set Mode Item 29: PAGER by pressing [F/W] → [7(P1)].*

*2) During Enhanced Paging & Code Squelch operation, you may set up the FT-60R such that a ringing “bell” sound alerts you to the fact that a call is coming in, as described previously. See page 25 for details.*

## Paging Answer Back

When you press the **PTT** switch to respond to a page call, the **FT-60R** transmits the same CTCSS tone pair. This tone pair will open the Code Squelch of the calling station. If you prefer, you can have the **FT-60R** respond to page calls automatically (“transpond”).

To enable this feature:

1. Press the **[F/W]** key, then press the **[0(⊗)SET]** key to enter the Set mode.
2. Rotate the **DIAL** knob to select Set Mode Item 30: PAG.ABK.
3. Press the **[F/W]** key momentarily to enable adjustment of this Set Mode Item.
4. Rotate the **DIAL** knob to select ABK. ON.
5. Press the **PTT** switch to save the new setting and exit to normal operation.



30  
PAG.ABK

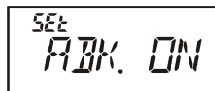

SET  
ABK. ON



*The Paging Answer Back feature constitutes a form of “remote control” operation that may be restricted to certain frequencies. U.S. users should confirm the current status of §97.201(b) of the FCC’s rules governing the Amateur service before utilizing this feature on the 144 MHz band.*

# EMERGENCY FEATURE

---

## EMERGENCY CHANNEL OPERATION

---

The **FT-60R** includes an “Emergency” feature which may be useful if you have someone monitoring on the same frequency as your transceiver’s UHF “Home” channel. See page 29 for details on setting the Home channel.

The “Emergency” feature is activated by pressing and holding in the **[4(RPT)]** key for one second. When this is done, (A) the radio is placed on the UHF amateur band Home channel, (B) it emits a loud “Alarm” sound (the volume is controlled by the **VOL** knob), (C) it flashes the LCD/keypad lamp, (D) if you press the **PTT** switch, you will disable the Emergency feature temporarily; you can then transmit on the UHF Home channel, and (E) two seconds after the **PTT** release, the Emergency feature will resume.

To disable the “Emergency” feature, press the **[FW]** key momentarily or turn the radio off by rotating the **VOL** knob fully counter-clockwise into the click-stop position.

Use this feature if you are out for a walk and want a quick way of alerting a family member as to a dangerous situation. The alarm sound may discourage an attacker and allow you to escape.



- 1) Be sure to arrange with a friend or family member to be monitoring on the same frequency, as there will be no identification sent via the Emergency alarm sound. And do not transmit the alarm tone except in a true emergency!*
- 2) The “Emergency” feature may be changed to another function via Set Mode Item 20: EMG S; see page 72 for details.*
- 3) If you place the radio in the “VHF Only” mode (see page 62 for details), the radio will transmit on the VHF Home channel when you press the PTT switch.*

---

## EMERGENCY AUTOMATIC ID (EAI) FEATURE

---

The Emergency Automatic ID (EAI) feature can be used for searching for persons who are incapacitated in disasters like earthquakes, especially search-and-rescue personnel who may have become injured in a debris field. In such cases, if another searcher sends out a unique command (CTCSS tone pair), the radio of the incapacitated party, who may not be able to speak or even press the **PTT** switch, will automatically cause the injured party’s radio to transmit, so others may perform direction-finding and effect a rescue. The call sign of the incapacitated person will also be transmitted, to assist the rescue team.

If an emergency group is working in a dangerous area, all members should engage the EAI feature on their transceiver, so that others can provide assistance to a fallen team member, if necessary.

The Emergency Automatic ID (EAI) Feature has two operating modes: (1) Interval mode and (2) Continuous mode.

In the Interval mode, when the **FT-60R** receives the CTCSS tone pair which is stored in the Receiving Pager Code Memory (configured via Set Mode Item 31: PAG.CDR) on the



## EMERGENCY AUTOMATIC ID (EAI) FEATURE

frequency which is stored in Memory Channel “000” for more than five seconds, the radio will automatically transmit a brief (0.5 second) beep tone every 2.5 seconds until the EAI timer expiration at the power level stored in that memory channel; it is NOT necessary for the incapacitated person to press the **PTT** switch.

In the Continuous mode, when the **FT-60R** receives the CTCSS tone pair which is stored in the Receiving Pager Code Memory (configured via Set Mode Item 31: PAG.CDR) on the frequency which is stored in Memory Channel “000” for more than five seconds, the radio will automatically transmit (with maximum microphone gain) *continuously*, until the EAI timer expiration, at the power level stored in that memory channel; it is NOT necessary for the incapacitated person to press the **PTT** switch.

Furthermore, if your call sign is stored in the radio via Set Mode Item 11: CW WRT and you have enabled the CW identifier by Set Mode Item 10: CWID, the radio will transmit your callsign on the air when the EAI feature is first engaged by the remote page, and every 10 minutes thereafter.

The “callsign” ID can be changed to any desired sequence of characters, such as a name. After sending the callsign or name, the radio will repeatedly transmit three tones for a user-defined period of time (between 1 and 30 minutes). The callsign or name will be transmitted every 10 minutes.

The Emergency Automatic ID (EAI) Feature requires that you (1) store the CTCSS Tone Pair into the Receiving Pager Memory (see page 44 for procedure), and (2) store the desired *UHF coordination frequency* into Memory Channel “000” (see page 28 for procedure).

To enable this feature:

1. Press the **[F/W]** key, then press the **[0(⊗)SET]** key to enter the Set mode.
2. Rotate the **DIAL** knob to select Set Mode Item 18: EAI.
3. Press the **[F/W]** key momentarily to enable adjustment of this Set Mode Item.
4. Rotate the **DIAL** knob to select the desired EAI mode (Interval EAI or Continuous EAI) and its transmit time (1-10, 15, 20, 30, 40, and 50 minutes) or OFF.
5. Press the **PTT** switch to save the new setting and exit to normal operation.
6. To disable the Emergency Automatic ID feature, just repeat the above procedure, rotating the **DIAL** knob to select “OFF” in step 4 above.

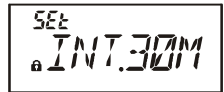
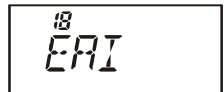

When the Emergency Automatic ID feature is activated, the “” icon will blink in the LCD.

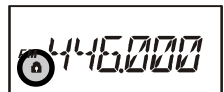

*The FT-60R will ignore the EAI feature when the (1) the squelch is open, (2) there is an incoming signal on the operating frequency, (3) the operating frequency is the same as the frequency which is stored in the Memory Channel “000,” or (4) a VHF frequency is stored in Memory Channel “000.”*

# SMART SEARCH OPERATION

The Smart Search feature allows you to load frequencies automatically according to where activity is encountered by your radio. When Smart Search is engaged, the transceiver will search above and below your current frequency, storing active frequencies as it goes (without stopping on them even momentarily); these frequencies are stored into a special Smart Search memory bank, consisting of 31 memories (15 above the current frequency, 15 below the current frequency, plus the current frequency itself).

Two basic operating modes for Smart Search are available:

**SINGLE:** In this mode, the transceiver will sweep the current band once in each direction starting on the current frequency. All channels where activity is present will be loaded into the Smart Search memories; whether or not all 31 memories are filled, the search will stop after one sweep in each direction.

**CONT:** In this mode, the transceiver will make one pass in each direction as with One-Shot searching; if all 31 channels are not filled after the first sweep, however, the radio will continue sweeping until they are all filled.

## Setting the Smart Search Mode

1. Press the **[F/W]** key, then press the **[0(⊗)SET]** key to enter the Set mode.
2. Rotate the **DIAL** knob to select Set Mode Item 42: S SRCH.
3. Press the **[F/W]** key momentarily to enable adjustment of this Set Mode Item.
4. Rotate the **DIAL** knob to select the desired Smart Search mode (see above).
5. When you have made your selection, press the **PTT** switch to save the setting and exit to normal operation.

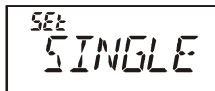
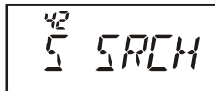

## Storing Smart Search Memories



1. Set the radio to the VFO mode. Be sure that you have the Squelch adjusted properly (so that band noise is quieted).
2. Press and hold in the **[3(TX PO)]** key for one second to begin the Smart Search scanning.
3. As active channels are detected, you will observe the number of “loaded” channels increasing in the regular memory channel window.
4. Depending on the mode you set for Smart Search operation (“SINGLE” or “CONT”), the Smart Search scan will eventually terminate, and the LCD will revert to Smart Search Memory Channel “C.”
5. To recall the Smart Search memories, rotate the **DIAL** knob to choose from among the frequencies stored by Smart Search.
6. To return to normal operation, press the **[V/M(PRI)]** key.



*Smart Search is a great tool when visiting a city for the first time. You don't need to spend hours looking up repeater frequencies from a reference guide-book. . .just ask your FT-60R where the action is!*

# INTERNET CONNECTION FEATURE

The **FT-60R** can be used to access a “node” (repeater or base station) which is tied into the Vertex Standard WIREST<sup>™</sup> (Wide-Coverage Internet Repeater Enhancement System) network, operating in the “SRG” (Sister Radio Group) mode. Details may be found at the WIREST-II Web site: <http://www.vxstd.com/en/wiresinfo-en/>. This feature may also be used to access other systems, as described below.

1. Press the **[0(⊗)SET]** key momentarily to activate the Internet Connection feature. The “⊗” icon will appear in the upper right corner of the display. 
2. Press and hold in the **[0(⊗)SET]** key for one second, then rotate the **DIAL** knob to select the access number (ICOD “0” ~ “9,” “A,” “B,” “C,” “D,” “E (\*),” “F (#),”) corresponding to the WIREST<sup>™</sup> node to which you wish to establish an Internet link (ask the node or repeater owner/operator if you don’t know the access number in the network). Now press the **PTT** switch to exit from the selection mode. 
3. With the Internet Connection feature activated (as in step 1 above), the **FT-60R** will generate a brief (0.1 second) DTMF tone according to your selection in step 2. This DTMF tone is sent at the beginning of every transmission to establish or maintain the link to the local WIREST<sup>™</sup> node operating in the SRG mode.
4. To disable the Internet Connection feature, press the **[0(⊗)SET]** key momentarily (the “⊗” icon will disappear from the display).



*If other users report that you always have a DTMF “beep” at the beginning of each transmission, and you are not operating in conjunction with Internet access, disable this function via step (4) above.*

You may access other Internet Link Systems (including WIREST<sup>™</sup> in the “FRG” mode) that use a DTMF string for access.

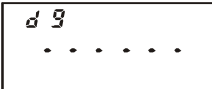
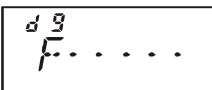
1. Load the DTMF tones which you wish to use for Internet-link access into a DTMF Autodial memory register. For purposes of this example, we will use “#123” as the access code.
  - A. Press the **[FW]** key, then press the **[0(⊗)SET]** key to enter the Set mode.
  - B. Rotate the **DIAL** knob to select Set Mode Item 17: DT WRT. 
  - C. Press the **[FW]** key to enable adjustment of this Set Mode Item. 
  - D. Rotate the **DIAL** knob to select the DTMF Memory register into which you wish to store the access code.
  - E. Press the **[FW]** key momentarily. The first digit will blink.
  - F. Rotate the **DIAL** knob to select “F” (representing DTMF “#”: the first digit of the DTMF string). 
  - G. Press the **[FW]** key momentarily to accept the first digit and move to the second digit of the DTMF string.

# INTERNET CONNECTION FEATURE

- H. Repeat the previous steps until you have completed the access code (“#123”).
- I. Press and hold in the **[F/W]** key for one second to save the setting.
2. Press the **PTT** switch to save the setting and exit to normal operation.
3. Press the **[F/W]** key, then press the **[0(⊗)SET]** key to enter the Set mode again.
4. Rotate the **DIAL** knob to select Set Mode Item 21: I NET.
5. Press the **[F/W]** key to enable adjustment of this Set Mode Item.
6. Rotate the **DIAL** knob to set this Set Mode Item to “INT.MEM” (thus activating the “Other Internet Link System” mode).
7. Press the **PTT** switch to save the new settings.
8. Press the **[0(⊗)SET]** key momentarily to activate the Internet Connection feature. The “⊗” icon will appear in the upper right corner of the display.
9. Press and hold in the **[0(⊗)SET]** key for one second, rotate the **DIAL** knob to select the DTMF access number (“IMEM 1” ~ “IMEM 9”) corresponding to the Internet link repeater to which you wish to establish an Internet link, then press the **PTT** switch momentarily to lock in the selected access number.
10. Once the Internet Connection feature is activated per step 8 above, you may now press the **[0(⊗)SET]** key, while you are transmitting, to send out the selected DTMF string (to establish the link to the desired Internet-link mode).
11. To return to the WIREST<sup>TM</sup> mode, repeat steps 3 - 6 above, selecting “INT.COD” in step 6.

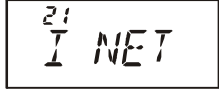

# ARTS™ (AUTOMATIC RANGE TRANSPONDER SYSTEM)

The ARTS™ feature uses DCS signaling to inform both parties when you and another ARTS™-equipped station are within communications range. This may be particularly useful during Search-and Rescue situations, where it is important to stay in contact with other members of your group.

Both stations must set up their DCS codes to the same code number, then activate their ARTS™ feature using the command appropriate for their radio. Alert ringers may be activated, if desired.

Whenever you push the **PTT**, or every 25 (or 15) seconds after ARTS™ is activated, your radio will transmit a signal which includes a (subaudible) DCS signal for about 1 second. If the other radio is in range, the beeper will sound (if enabled) and the display will show “IN.RNG” as opposed to the out of range display “OUT.RNG” in which ARTS™ operation begins.

Whether you talk or not, the polling every 15 or 25 seconds will continue until you de-activate ARTS™. Every 10 minutes, moreover, you can have your radio transmit your callsign via CW, so as to comply with identification requirements. When ARTS™ is de-activated, DCS will also be deactivated (if you were not using it previously in non-ARTS™ operation).

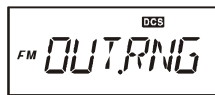

If you move out of range for more than one minute (four pollings), your radio will sense that no signal has been received, three beeps will sound, and the display will revert to “OUT.RNG.” If you move back into range, your radio will again beep, and the display will change back to the “IN.RNG” indication.

During ARTS™ operation, it is not possible to change the operating frequency or other settings; you must terminate ARTS™ in order to resume normal operation. This is a safety feature designed to prevent accidental loss of contact due to channel change, etc.

## Basic ARTS™ Setup and Operation

1. Set your radio and the other radio(s) to the same DCS code number, per the discussion on page 23.
2. Press and hold in the **[2(CODE)]** key for one second. You will observe the “OUT.RNG” display on the LCD below the operating frequency. ARTS™ operation has now commenced.
3. Every 25 seconds, your radio will transmit a “polling” call to the other station. When that station responds with its own ARTS™ polling signal, the display will change to “IN.RNG” to confirm that the other station’s polling code was received in response to yours.
4. Press the **[FW]** key momentarily to exit ARTS™ operation and resume normal functioning of the transceiver.

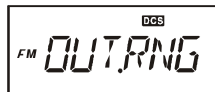

# ARTS™ (AUTOMATIC RANGE TRANSPONDER SYSTEM)



*ARTS™ constitutes a form of “remote control” operation that may be restricted to certain frequencies. U.S. users should confirm the current status of §97.201(b) of the FCC’s rules governing the Amateur service before utilizing this feature on the 144 MHz band.*

## ARTS™ Polling Time Options

The ARTS™ feature may be programmed to poll every 25 seconds (default value) or 15 seconds. The default value provides maximum battery conservation, because the polling signal is sent out less frequently. To change the polling interval:

1. Press the **[F/W]** key, then press the **[0(⊗)SET]** key to enter the Set mode.
2. Rotate the **DIAL** knob to select Set Mode Item 3: AR INT.
3. Press the **[F/W]** key momentarily to enable adjustment of this Set Mode Item.
4. Rotate the **DIAL** knob to select the desired polling interval (15 or 25 seconds).
5. When you have made your selection, press the **PTT** switch to save the new setting and exit to normal operation.

3  
AR INT

SET  
25 SEC

## ARTS™ Alert Beep Options

The ARTS™ feature allows two kinds of alert beeps (with the additional option of turning them off), so as to alert you to the current status of ARTS™ operation. Depending on your location and the potential annoyance associated with frequent beeps, you may choose the Beep mode which best suits your needs. The choices are:

**INRANG:** The beeps are issued only when the radio first confirms that you are within range, but does not re-confirm with beeps thereafter.

**ALWAYS:** Every time a polling transmission is received from the other station, the alert beeps will be heard.

**OFF:** No alert beeps will be heard; you must look at the display to confirm current ARTS™ status.

To set the ARTS™ Beep mode, use the following procedure:

1. Press the **[F/W]** key, then press the **[0(⊗)SET]** key to enter the Set mode.
2. Rotate the **DIAL** knob to select Set Mode Item 2: AR BEP.
3. Press the **[F/W]** key momentarily to enable adjustment of this Set Mode Item.
4. Rotate the **DIAL** knob to select the desired ARTS™ Beep mode (see above).
5. When you have made your selection, press the **PTT** switch to save the new setting and exit to normal operation.

2  
AR BEP

SET  
ALWAYS

# ARTS™ (AUTOMATIC RANGE TRANSPONDER SYSTEM)

## CW Identifier Setup

The ARTS™ feature includes a CW identifier, as discussed previously. Every ten minutes during ARTS™ operation, the radio can be instructed to send “DE (your callsign) K” if this feature is enabled. The callsign field may contain up to 6 characters.

Here’s how to program the CW Identifier:

1. Press the **[F/W]** key, then press the **[0(⊗)SET]** key to enter the Set mode.
2. Rotate the **DIAL** knob to select Set Mode Item 11: CW WRT.
3. Press the **[F/W]** key momentarily to display any previously-stored callsign.
4. Press the **[F/W]** key again to *clear* any previous callsign.
5. Rotate the **DIAL** knob to select the first letter/number of your callsign, then press the **[F/W]** key momentarily to save the first letter/number and move on to the next character.
6. Repeat the previous step, as many times as necessary, to complete your callsign. If you make a mistake, press the **[▼(MHz)]** key to move back to the previous letter/number’s slot, then re-select the correct letter/number.
7. When you have finished entering your entire callsign and it contains less than 6 characters, press and hold in the **[F/W]** key for one second to confirm the callsign. (if your callsign has exactly 6 characters, you do not need to press and hold in **[F/W]** in this step).
8. Press the **PTT** switch to save the settings and exit to normal operation.
9. Press the **[F/W]** key, then press the **[0(⊗)SET]** key to enter the Set mode again.
10. Rotate the **DIAL** knob to select Set Mode Item 10: CWID.
11. Press the **[F/W]** key momentarily to enable adjustment of this Set Mode Item.
12. Rotate the **DIAL** knob to set this Item to “TX ON” (to enable the CW ID function).
13. Press the **PTT** switch to save the settings and exit to normal operation.

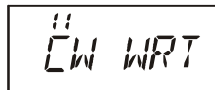

11  
CW WRT

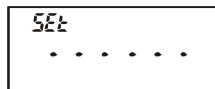

SET  
· · · · ·

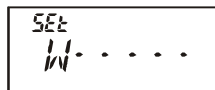

SET  
W · · · · ·

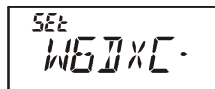

SET  
W6DXC ·



10  
CWID

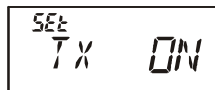

SET  
TX ON



*You may check your work by monitoring the entered callsign. To do this, repeat steps 1- 7 above, then press the MONI switch.*

# DTMF OPERATION

The **FT-60R**'s 16-button keypad allows easy DTMF dialing for Autopatch, repeater control, or Internet-link access purposes. Besides numerical digits [0] through [9], the keypad includes the [\*] and [#] digits, plus the [A], [B], [C], and [D] tones often used for repeater control.

## Manual DTMF Tone Generation

You can generate DTMF tones during transmission manually.

1. Press the [F/W] key, then press the [9(DTMF)] key to disable the DTMF Autodialer, if necessary. The "CODE" indication will appear in the display for a moment.
2. Press the PTT switch to begin transmission.
3. While transmitting, press the desired numbers on the keypad.
4. When you have sent all the digits desired, release the PTT switch.



## DTMF Autodialer

Nine DTMF Autodial memories are provided, allowing you to store telephone numbers for autopatch use. You can also store short autopatch or Internet-link access code streams so as to avoid having to send them manually.

Here is the DTMF Autodial storage procedure:

1. Press the [F/W] key, then press the [0(⊗)SET] key to enter the Set mode.
2. Rotate the **DIAL** knob to select Set Mode Item 17: DT WRT.
3. Press the [F/W] key momentarily to enable adjustment of this Set Mode Item.
4. Rotate the **DIAL** knob to select the DTMF Memory register into which you wish to store this DTMF string.
5. Press the [F/W] key momentarily to begin DTMF Memory entry into the selected register.
6. Rotate the **DIAL** knob to select the first digit of the DTMF string. Selectable entries are 0 - 9, and A - F, with E and F representing DTMF "\*" and "#" tones respectively.
7. Press the [F/W] key to accept the first digit and move to the next digit of the DTMF string.
8. Repeat steps 5 and 6 until you have completed the telephone number.
9. If you make a mistake, press the [▼(MHz)] key to move back to the previous digit, then re-select the correct number.
10. If the telephone number made up of numbers only, you may key in the telephone number directly from the keypad.
11. Press and hold in the [F/W] key for one second to save the setting.

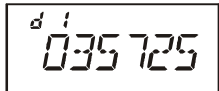
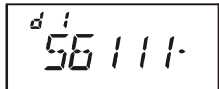
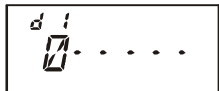
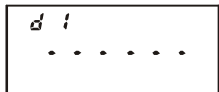



12. If you store other numbers, repeat steps 4- 10 above, using a different DTMF memory register.
13. When all required DTMF memories are filled to your satisfaction, press the **PTT** switch to save the settings and exit to normal operation



*You may check your work by monitoring the entered DTMF string. To do this, repeat steps 1- 4 above, then press the **MONI** switch.*

To send the telephone number:

1. Press the [**F/W**] key, then press the [**9(DTMF)**] key to activate the DTMF Autodialer. The “MEM” indication display will appear in the display for a moment. 
2. While the DTMF Autodialer is activated, first press the **PTT** switch, then press the numerical key ([**1**] through [**9**]) corresponding to the DTMF memory string you wish to send. Once the string begins, you may release the **PTT** switch, as the transmitter will be held “on the air” until the DTMF string is completed.
3. To disable the DTMF Autodialer, press [**F/W**] → [**9(DTMF)**] again. The “CODE” indication will appear in the display for a moment.

You can change the DTMF Audodialer sending speed, using Set Mode Item 16: DT SPD. See page 71 for details.

You can also set a longer delay between the time you press the numerical key (corresponding to the DTMF memory string; with PTT switch pressed) and the instant when the first DTMF digit is sent, using Set Mode Item 15: DT DLY. See page 71 for details.

# MISCELLANEOUS SETTINGS

## PASSWORD

The **FT-60R** provides the password feature which can minimize the chance that your transceiver could be used by an unauthorized party.

When the password feature is activated, the radio will ask for the four digit password to be entered when the radio is first turned on. You must enter the four digit password from the keypad. If the wrong password is entered, the microprocessor will shut down the radio automatically.

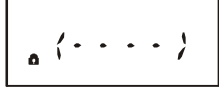

To enter the password, use the following procedure:

1. Press the **[F/W]** key, then press the **[0(⊗)SET]** key to enter the Set mode.
2. Rotate the **DIAL** knob to select Set Mode Item 34: PSWD W.
3. Press the **[F/W]** key momentarily to display any previously-stored password.
4. Press the **[F/W]** key again to clear any previous password.
5. Rotate the **DIAL** knob to select the first digit of the desired number/letter (0-9, A, B, C, D, E (substitute for “\*”), and F (substitute for “#”).
6. Press the **[F/W]** key to move to the next digit.
7. Repeat steps 5 and 6 to program the remaining numbers/letters of the desired password.
8. If you make a mistake, press the **[▼(MHz)]** key to move back to the previous digit, then re-select the correct number/letter.
9. If your password is made up of numbers only, you may enter your password directly from the keypad. For example, to enter the “1234” as your password, press **[1] → [2] → [3] → [4]**.
10. When you have finished entering the password, press the **PTT** switch to save the new setting and exit to normal operation.

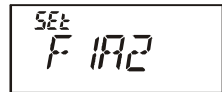
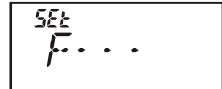
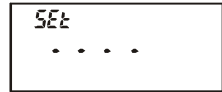

*We recommend that you to write down the password number, and keep it in a safe place you can easily find if you forget your password.*

To Activate the Password feature:

1. Press the **[F/W]** key, then press the **[0(⊗)SET]** key to enter the Set mode.
2. Rotate the **DIAL** knob to select Set Mode Item 33: PSWD.
3. Press the **[F/W]** key momentarily to enable adjustment of this Item.
4. Rotate the **DIAL** knob to set this Set Mode Item to “PWD. ON.”
5. When you have made your selection, press the **PTT** switch to save the new setting and exit to normal operation.
6. If you wish to disable the Password feature, just repeat the above procedure, rotating the **DIAL** knob to select “PWD.OFF” in step 4 above.

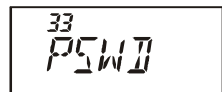

# MISCELLANEOUS SETTINGS

## PASSWORD



*If you forget the password number, you may turn on the transceiver by performing the “All Reset” procedure (see page 64). However, the FT-60R will clear the password, as well as all memories, and will restore all other settings to factory defaults.*

## PROGRAMMING THE KEY ASSIGNMENTS

Default **FT-60R** Set Mode Items have been assigned (at the factory) to the [7(P1)] and [8(P2)] keys. These may be changed by the user, if you wish to assign another Set Mode Item to either or both of these keys.

To change the assignment of a key’s Set Mode Item:

1. Press the [F/W] key, then press the [0(⊗)SET] key to enter the Set mode.
2. Rotate the **DIAL** knob to select the Set Mode Item which you wish to assign to the key as a Menu short-cut.
3. Press and hold in the [7(P1)] or [8(P2)] key for one second to assign the Set Mode Item to the [7(P1)] or [8(P2)] key.

*The following Set Mode Items may not be assigned to the [7(P1)] and [8(P2)] keys.*

*Set Mode Item 11: CW WRT*

*Set Mode Item 17: DT WRT*

*Set Mode Item 28: NW WRT*

*Set Mode Item 34: PSWD W*

## CHANGING THE CHANNEL STEPS

The **FT-60R**’s synthesizer provides the option of utilizing channel steps of 5/10/12.5/15/20/25/50/100 kHz per step, as well as an automatic step selection based on the current operating frequency (“AUTO”), any number of which may be important to your operating requirements. The **FT-60R** is set up at the factory in the “AUTO” configuration, which probably is satisfactory for most operation. However, if you need to change the channel step increments, the procedure to do so is very easy.

1. Press the [F/W] key, then press the [0(⊗)SET] key to enter the Set mode.
2. Rotate the **DIAL** knob to select Set Mode Item 49: STEP.
3. Press the [F/W] key momentarily to enable adjustment of this Item.
4. Rotate the **DIAL** knob to select the new channel step size.
5. When you have made your selection, press the **PTT** switch to save the new setting and return to normal operation.

# MISCELLANEOUS SETTINGS

## CHANGING THE RECEIVING MODE

The **FT-60R** provides for automatic mode changing when the radio is tuned to different operating frequencies. However, should an unusual operating situation arise in which you need to change between the available operating modes (FM and AM), here is the procedure for doing so:

1. Press the **[FW]** key, then press the **[0(⊗)SET]** key to enter the Set mode.
2. Rotate the **DIAL** knob to select Set Mode Item 40: RX MOD.
3. Press the **[FW]** key momentarily to enable adjustment of this Item.
4. Rotate the **DIAL** knob to select the new operating mode. The available selections are:  
AUTO: Automatic mode setting per default values for the selected frequency range.  
FM: Frequency Modulation  
AM: Amplitude Modulation
5. When you have made your selection, press the **PTT** switch to save the new setting and return to normal operation.

The LCD display shows the number '40' in the top left corner, followed by 'RX' and 'MOD' in a larger font.

The LCD display shows 'SET' in the top left corner, with 'AM' in a smaller font below it, and a larger 'AM' in the center.



*Unless you have a compelling reason to do so, leave the Automatic Mode Selection feature on so as to save time and trouble when changing bands. If you make a mode change for a particular channel or station, you can always store that one channel into memory, as the mode setting will be memorized along with the frequency information.*

# MISCELLANEOUS SETTINGS

## RECEIVE BATTERY SAVER SETUP

An important feature of the **FT-60R** is its Receive Battery Saver, which “puts the radio to sleep” for a time interval, periodically “waking it up” to check for activity. If somebody is talking on the channel, the **FT-60R** will remain in the “active” mode, then resume its “sleep” cycles. This feature significantly reduces quiescent battery drain, and you may change the amount of “sleep” time between activity checks using the Set Mode:

1. Press the **[F/W]** key, then press the **[0(⊗)SET]** key to enter the Set mode.
2. Rotate the **DIAL** knob to select Set Mode Item 41: RXSAVE.
3. Press the **[F/W]** key momentarily to enable adjustment of this Set Mode Item.
4. Rotate the **DIAL** knob to select the desired “sleep” duration. The selections available are 200 ms, 300 ms, 500 ms, 1 second, 2 seconds, or OFF. The default value is 200 ms.
5. When you have made your selection, press the **PTT** switch to save the new setting and exit to normal operation.

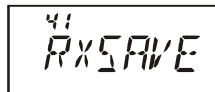

41  
RXSAVE

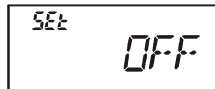

SEL  
OFF



*When you are operating on Packet, switch the Receive Battery Saver OFF, as the sleep cycle may “collide” with the beginning of an incoming Packet transmission, causing your TNC not to receive the full data burst.*

## TX BATTERY SAVER

The **FT-60R** also includes a useful Transmit Battery Saver, which will automatically lower the power output level when the last signal received was very strong. For example, when you are in the immediate vicinity of a repeater station, there generally is no reason to use the High Power output in order to achieve full-quieting access to the repeater. With the Transmit Battery Saver, the automatic selection of Low Power operation conserves battery drain significantly.

To activate the Transmit Battery Saver:

1. Press the **[F/W]** key, then press the **[0(⊗)SET]** key to enter the Set mode.
2. Rotate the **DIAL** knob to select Set Mode Item 53: TXSAVE.
3. Press the **[F/W]** key momentarily to enable adjustment of this Set Mode Item.
4. Rotate the **DIAL** knob to set this Set Mode Item to “SAV. ON” (thus activating the Transmit Battery Saver).
5. When you have made your selection, press the **PTT** switch to save the new setting and exit to normal operation.

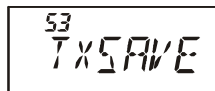

53  
TXSAVE

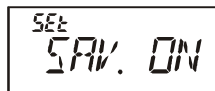

SEL  
SAV. ON

# MISCELLANEOUS SETTINGS

## DISABLING THE TX/BUSY INDICATOR

Further battery conservation may be accomplished by disabling the **TX** indicator while transmitting and disabling the **BUSY** indicator while receiving a signal. Use the following procedure:

1. Press the **[FW]** key, then press the **[0(⊗)SET]** key to enter the Set mode.
2. Rotate the **DIAL** knob to select Set Mode Item 8: BSY.LED if you wish to disable the **BUSY** indicator or Set Mode Item 52: TX.LED if you wish to disable the **TX** indicator.
3. Press the **[FW]** key momentarily to enable adjustment of this Set Mode Item.
4. Rotate the **DIAL** knob to set this Set Mode Item to “LED.OFF” (thus disabling the **BUSY** or **TX** indicator).
5. When you have made your selection, press the **PTT** switch to save the new setting and exit to normal operation.
6. If you wish to re-enable the **TX/BUSY** Indicator, just repeat the above procedure, rotating the **DIAL** knob to select “LED. ON” in step 4 above.

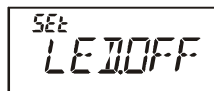
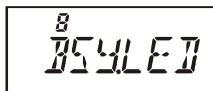

## AUTOMATIC POWER-OFF (APO) FEATURE

The APO feature helps conserve battery life by automatically turning the radio off after a user-defined period of time within which there has been no dial or key activity. The available selections for the time before power-off are 0.5 to 12.0 hours in 0.5 hour multiple, as well as APO Off. The default condition for the APO is OFF, and here is the procedure for activating it:

1. Press the **[FW]** key, then press the **[0(⊗)SET]** key to enter the Set mode.
2. Rotate the **DIAL** knob to select Set Mode Item 1: APO.
3. Press the **[FW]** key momentarily to enable adjustment of this Set Mode Item.
4. Rotate the **DIAL** knob to select the desired time period after which the radio will automatically shut down.
5. When you have made your selection, press the **PTT** switch to save the new setting and exit to normal operation.

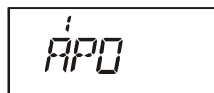

When the APO is activated, the “**⓪**” icon will appear at the upper right corner on the LCD. If there is no action by you within the time interval programmed, the microprocessor will shut down the radio automatically.

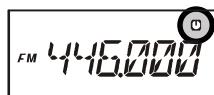

Rotate the **VOL/PWR** knob counter-clockwise to the “off” position, then clockwise out of the click-stop, to turn the radio on after an APO shutdown.

# MISCELLANEOUS SETTINGS

## TRANSMITTER TIME-OUT TIMER (TOT)

The TOT feature provides a safety switch which limits transmission time to a pre-programmed value. This will promote battery conservation by not allowing you to make excessively-long transmissions, and in the event of a stuck **PTT** switch (perhaps if the radio or a Speaker/Mic is wedged between car seats) it can prevent interference to other users as well as battery depletion. As configured at the factory the TOT feature is set to OFF, and here is the procedure for activating it:

1. Press the **[F/W]** key, then press the **[0(⊗)SET]** key to enter the Set mode.
2. Rotate the **DIAL** knob to select Set Mode Item 51: TOT.
3. Press the **[F/W]** key momentarily to enable adjustment of this Set Mode Item.
4. Rotate the **DIAL** knob to set the Time-Out Timer to the desired “Maximum TX” time (between 1 and 30 minutes), or OFF.
5. When you have made your selection, press the **PTT** switch to save the new setting and exit to normal operation.



51  
TOT

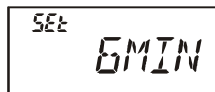

SET  
6MIN



- 1) *When your transmission time is within 10 seconds of the Time-Out Timer expiration, an Alert bell will provide an audible warning from the speaker.*
- 2) *Since brief transmissions are the mark of a good operator, try setting up your radio's TOT feature for a maximum transmission time of one minute. This will significantly improve battery life, too!*

## BUSY CHANNEL LOCK-OUT (BCLO)

The BCLO feature prevents the radio's transmitter from being activated if a signal strong enough to break through the “noise” squelch is present. On a frequency where stations using different CTCSS or DCS codes may be active, BCLO prevents you from disrupting their communications accidentally (because your radio may be muted by its own Tone Decoder). The default setting for the BCLO is OFF, and here is how to change that setting:

1. Press the **[F/W]** key, then press the **[0(⊗)SET]** key to enter the Set mode.
2. Rotate the **DIAL** knob to select Set Mode Item 5: BCLO.
3. Press the **[F/W]** key momentarily to enable adjustment of this Set Mode Item.
4. Rotate the **DIAL** knob to set this Set Mode Item to “BCL. ON” (thus activating the BCLO feature).
5. When you have made your selection, press the **PTT** switch to save the new setting and exit to normal operation.



5  
BCLO



SET  
BCL. ON

# MISCELLANEOUS SETTINGS

## MONO BAND OPERATION

You may place the radio in a “VHF Only” or “UHF Only” mode which will cause it to function as a 144 MHz or 430 MHz Mono band transceiver.

To place the radio into the Mono band operation configuration:

1. Turn the radio off.
2. Press and hold in the **MONI** switch (just below the **PTT** switch) while turning the radio on.
3. Rotate the **DIAL** knob to select the configuration mode menu:  
F6 V-ONLY: The **FT-60R** will operate on the 144 MHz band only.  
F7 U-ONLY: The **FT-60R** will operate on the 430 MHz band only.
4. Press the [**F/W**] key momentarily.



F6  
V-ONLY



F7  
U-ONLY

To return to normal operation, press and hold in the **MONI** switch while turning the radio on, and then press the [**F/W**] key momentarily.

## CHANGING THE TX DEVIATION LEVEL

In many areas of the world, channel congestion has required that operating channels be closely spaced. In such operating environments, it often is required that operators use reduced deviation levels, so as to reduce the potential for interference to users on adjacent channels. The **FT-60R** includes a simple method of accomplishing this:

1. Press the [**F/W**] key, then press the [**0(⊗)SET**] key to enter the Set mode.
2. Rotate the **DIAL** knob to select Set Mode Item 55: WID.NAR.
3. Press the [**F/W**] key momentarily to enable adjustment of this Set Mode Item.
4. Rotate the **DIAL** knob to set this Set Mode Item to “NARROW.”  
In this configuration (HALF DEVIATION active), the transmitter’s deviation will be approximately  $\pm 2.5$  kHz, and the received audio output level will be increased, for easier listening on the narrow signal.
5. When you have made your selection, press the **PTT** switch to save the new setting and exit to normal operation.



55  
WID.NAR



SET  
NARROW

*The “normal” setting for the deviation (when this Menu Item is set to WIDE) is  $\pm 5$  kHz.*



## DCS CODE INVERSION

The DCS system was first introduced in the commercial LMR (Land Mobile Radio) service, where it is now in widespread use. DCS is sometime referred to by its different proprietary names, such as DPL® (Digital Private Line®, a registered trademark of Motorola, Inc.).

DCS uses a codeword consisting of a 23-bit frame, transmitted (subaudible) at a data rate of 134.4 bps (bit/sec). Occasionally, signal inversion can result in the complement of a code to be sent or received. This prevents the receiver's squelch from opening with DCS enabled, as the decoded bit sequence would not match that selected for operation.

Typical situations that might cause inversion to occur are:

- Connection of an external receiver preamplifier.
- Operating through a repeater.
- Connection of an external linear amplifier.

Note that code inversion does not mean that any of the above listed equipment is defective!

In certain amplifier configurations, the output signal (phase) is inverted from the input. Small signal or power amplifiers having an odd number (1, 3, 5, etc.) of amplification stages may result in inversion of a transmitted or received DCS code.

While under most circumstances this should not occur (amplifier designs and industry standards take this into account), if you find that your receiver squelch does not open when both you and the other station are using a common DCS code, you or the other station (but not both) can try the following:

1. Press the **[F/W]** key, then press the **[0(⊗)SET]** key to enter the Set mode.
2. Rotate the **DIAL** knob to select Set Mode Item 14: DCS.N/R.
3. Press the **[F/W]** key momentarily, then rotate the **DIAL** knob to select one of the following modes:

T/RX N: Encoder, Normal; Decoder, Normal

RX R: Encoder, Normal; Decoder, Reverse (Inverted)

TX R: Encoder, Reverse (Inverted); Decoder, Normal

T/RX R: Encoder, Reverse (Inverted); Decoder, Reverse (Inverted)

4. When you have made your selection, press the **PTT** switch to save the new setting and exit to normal operation.
5. Remember to restore the default setting to "T/RX N" (Encoder; Normal, Decoder; Normal) when done.

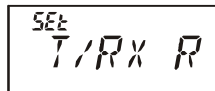
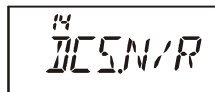

# RESET PROCEDURES

---

In the event of erratic operation of the transceiver, it is possible that data on the microprocessor may have become corrupted. While this is a highly unusual situation, the only path to recovery may involve resetting of the microprocessor. Here's how to do this:

1. Turn the radio off.
2. Press and hold in the **MONI** switch (just below the **PTT** switch) while turning the radio on.
3. Rotate the **DIAL** knob to select one choice from the reset menu:
  - F1 SETRST: Resets the Set (Menu) mode settings to their factory defaults.
  - F2 MEMRST: Clears the Memory settings to factory defaults.
  - F3 MB RST: Clears the Memory Bank Assignments.
  - F4 ALLRST: Clears all memories and other settings to factory defaults.
4. Press the [**F/W**] key momentarily to complete the reset procedure.



The **FT-60R** includes a convenient “Clone” feature, which allows the memory and configuration data from one transceiver to be transferred to another **FT-60R**. This can be particularly useful when configuring a number of transceivers for a public service operation. Here is the procedure for Cloning one radio’s data to another:

1. Turn both radios off.
2. Connect the optional **CT-27** Clone Cable between the **MIC/SP** jacks of the two radios.
3. Press and hold in the **MONI** switch (just below the **PTT** switch) while turning the radios on. Do this for both radios (the order of switch-on does not matter).
4. Rotate the **DIAL** knob on each radio to select to “F8 CLONE,” then press the [**F/W**] key momentarily.
5. The display will disappear for a moment, then the “CLONE” notation will appear on the displays of both radios when the Clone mode is successfully activated in this step.
6. On the Destination radio, press the **MONI** switch (“--RX--” will appear on the LCD).
7. Press and hold the **PTT** switch for one second on the Source radio; “--TX--” will appear on the Source radio, and the data from this radio will be transferred to the other radio.
8. If there is a problem during the cloning process, “ERROR” will be displayed. Check your cable connections and battery voltage, and try again.
9. If the data transfer is successful, “CLONE” will reappear on both displays. Turn both radios off and disconnect the cloning cable. You can then turn the radios back on, and begin normal operation.

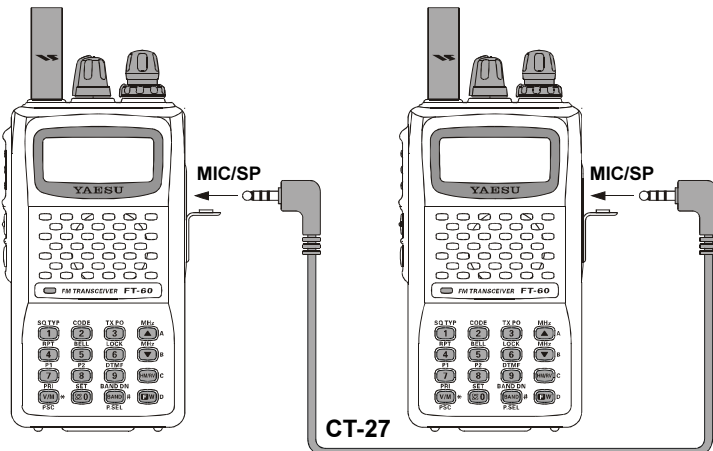
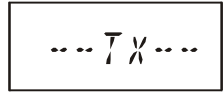

# SET (MENU) MODE

The **FT-60R** Set Mode, already described in parts of many previous chapters, is easy to activate and set. It may be used for configuration of a wide variety of transceiver parameters, some of which have not been detailed previously. Use the following procedure to activate the Set Mode:

1. Press the **[F/W]** key, then press the **[0(∅)SET]** key to enter the Set mode.
2. Rotate the **DIAL** knob to select the Set Mode Item to be adjusted.
3. Press the **[F/W]** key momentarily to enable adjustment of the Set Mode Item.
4. Rotate the **DIAL** knob to adjust or select the parameter to be changed on the Set Mode Item selected in above step.
5. After completing your selection and adjustment, press the **PTT** switch momentarily to save the new setting and exit to normal operation.

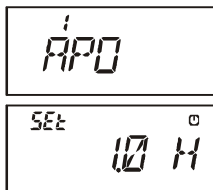

*1) Some Set Mode Items (like Set Mode Item 50: TN FRQ) require that the [F/W] key be pressed after setting of the parameter, and before exiting to normal operation.*

*2) Two Set Mode Item numbers (In the factory default, Set Mode Item 29: PAGER, and 46: SKIP) will blink while selecting the Set Mode Item; this indicates that this Set Mode Item has been assigned to the [7(P1)] or [8(P2)] key of the keypad.*

| SET MODE ITEM | FUNCTION  | AVAILABLE VALUES<br>(DEFAULT: BOLD ITALIC)              |
|---------------|---|---|
| 1 [APO]       | Setting of the Automatic Power-Off feature.   | <b>OFF</b> / 0.5H - 12.0 H                              |
| 2 [AR BEP]    | Selects the Beep option during ARTS operation.  | <b>INRANG</b> / ALWAYS / OFF                            |
| 3 [AR INT]    | Selects the Polling Interval during ARTS operation.   | <b>25 SEC</b> / 15 SEC                                  |
| 4 [ARS]       | Enables/Disables the Automatic Repeater Shift function.                                       | <b>ARS. ON</b> / ARS.OFF                                |
| 5 [BCLO]      | Enables/Disables the Busy Channel Lock-Out feature.   | <b>BCL. ON</b> / <b>BCL.OFF</b>                         |
| 6 [BEEP]      | Enables/Disables the beeper.  | <b>KEY+SC</b> / KEY / OFF                               |
| 7 [BELL]      | Selects the number of CTCSS/DCS Bell ringer repetitions.                                      | <b>OFF</b> / 1T / 3T /<br>5T / 8T / CONT                |
| 8 [BSY.LED]   | Enables/Disables the <b>BUSY</b> LED while the Squelch is open.                               | <b>LED. ON</b> / LED.OFF                                |
| 9 [CLK.SFT]   | Shifting of the CPU clock frequency.  | <b>SFT.OFF</b> / SFT. ON                                |
| 10 [CWID]     | Enables/disables the CW identifier during ARTS operation.                                     | <b>TX OFF</b> / TX ON                                   |
| 11 [CW WRT]   | Programs and activates the CW Identifier.   | ---   |
| 12 [DC VLT]   | Indicates the DC Supply Voltage.  | ---   |
| 13 [DCS.COD]  | Setting of the DCS code.  | 104 DCS codes ( <b>023</b> )                            |
| 14 [DCS.N/R]  | Enables/Disables "Inverted" DCS code decoding.  | <b>T/RX N</b> , RX R,<br>TX R, T/RX R                   |
| 15 [DT DLY]   | Setting of the DTMF Autodialer Delay Time.  | 50MS / 100MS / 250MS /<br><b>450MS</b> / 750MS / 1000MS |
| 16 [DT SPD]   | Setting of the DTMF Autodialer Sending Speed.   | <b>50MS</b> / 100MS                                     |
| 17 [DT WRT]   | Programming of the DTMF Autodialer.   | ---   |
| 18 [EAI]      | Enables/Disables the Emergency Automatic ID (EAI) Feature.                                    | INT. 1M - INT. 50M /<br>CON. 1M - CON.50M / <b>OFF</b>  |
| 19 [EDG.BEP]  | Enables/Disables the Band-edge beeper while selecting the frequency via the <b>DIAL</b> knob. | <b>BEP.OFF</b> / BEP. ON                                |

# SET (MENU) MODE

| SET MODE ITEM | FUNCTION  | AVAILABLE VALUES<br>(DEFAULT: <b>BOLD</b> <i>ITALIC</i> )                        |
|---------------|---|--|
| 20 [EMG S]    | Selects the alarm(s) utilized when the Emergency function is engaged.                     | EMG.BEP / EMG.LMP / <b>EMG.B+L</b> / EMG.CWT / EMG.C+B / EMG.C+L / EMG.ALL / OFF |
| 21 [I NET]    | Selects the Internet Link Connection mode.  | <b>INT.OFF</b> / INT.COD / INT.MEM   |
| 22 [INT CD]   | Selects the Access Number (DTMF digit) for WIRES™ operation.                              | CODE 0 - CODE 9<br>( <b>CODE 1</b> )   |
| 23 [INT MR]   | Selects the memory register for an Access Number (DTMF code) for non-WIRES™               | d1 - d9  |
| 24 [LAMP]     | Selects the LCD/Keypad Lamp mode.   | <b>KEY</b> / 5SEC / TOGGLE   |
| 25 [LOCK]     | Selects the Control Locking lockout combination.  | LK KEY / LKDIAL / <b>LK K+D</b> / LK PTT / LK P+K / LK P+D / LK ALL              |
| 26 [M/T-CL]   | Selects the <b>MONI</b> switch function.  | <b>MONI</b> / T-CALL   |
| 27 [NAME]     | Toggles the display indication between "frequency" and the channel's "Alpha/Numeric Tag." | <b>FREQ</b> / ALPHA  |
| 28 [NM WRT]   | Stores Alpha-Numeric "Tags" for the Memory channels.                                      | ---  |
| 29 [PAGER]    | Enables/disables the Enhanced CTCSS Paging & Code Squelch function.                       | <b>PAG.OFF</b> / PAG. ON   |
| 30 [PAG.ABK]  | Enables/disables the Answer Back function of the Enhanced CTCSS Paging & Code Squelch.    | <b>ABK.OFF</b> / ABK. ON   |
| 31 [PAG.CDR]  | Setting the Receiver Pager Code for the Enhanced CTCSS Paging & Code Squelch.             | (05_47)  |
| 32 [PAG.CDT]  | Setting the Transmitting Pager Code for the Enhanced CTCSS Paging & Code Squelch.         | (05_47)  |
| 33 [PSWD]     | Enables/disables the Password feature.  | <b>PWD.OFF</b> / PWD. ON   |
| 34 [PSWD W]   | Stores the password.  | ---  |
| 35 [RESUME]   | Selects the Scan Resume mode.   | <b>BUSY</b> / HOLD / TIME  |
| 36 [REV/HM]   | Selects the function of the [HM/RV] key.  | <REV> / <HOME>   |
| 37 [RF SQL]   | Adjusts the RF Squelch threshold level.   | S-1 / S-2 / S-3 / S-4 / S-5 / S-6 / S-8 / S-FULL / <b>OFF</b>                    |
| 38 [RPT.MOD]  | Sets the Repeater Shift Direction.  | RPT.OFF / RPT.- / RPT. + (※)   |
| 39 [PRI. RVT] | Enables/disables the Priority Revert feature.   | <b>RVT.OFF</b> / RVT. ON   |
| 40 [RX MOD]   | Selects the receiving mode.   | <b>AUTO</b> / FM / AM  |
| 41 [RXSAVE]   | Selects the Receive-mode Battery Saver interval ("sleep" ratio)                           | <b>200 MS</b> / 300 MS / 500 MS / 1 S / 2 S / OFF                                |
| 42 [S SRCH]   | Selects the Smart Search Sweep mode.  | <b>SINGLE</b> / CONT   |
| 43 [SCN MD]   | Selects the Memory Scan channel-selection mode.   | <b>ONLY</b> / <b>MEM</b>   |
| 44 [SCN.LMP]  | Enables/Disables the Scan lamp while paused.  | <b>ON</b> / OFF  |
| 45 [SHIFT]    | Sets the magnitude of the repeater Shift.   | 0.00 - 99.95 MHz (※)   |
| 46 [SKIP]     | Selects the Memory Scan "Skip" channel-selection mode.                                    | <b>OFF</b> / SKIP / ONLY   |
| 47 [SPLIT]    | Enables/Disables split CTCSS/DCS coding.  | <b>SPL.OFF</b> / SPL. ON   |
| 48 [SQL.TYP]  | Selects the Tone Encoder and/or Decoder mode.   | <b>OFF</b> / TONE / TSQL / REV TN / DCS  |
| 49 [STEP]     | Setting of the synthesizer steps.   | 5 / 10 / 12.5 / 15 / 20 / 25 / 50 / 100 kHz, or <b>AUTO</b>                      |
| 50 [TN FRQ]   | Setting of the CTCSS Tone Frequency.  | 50 CTCSS tones ( <b>100 Hz</b> )   |
| 51 [TOT]      | Setting of the TOT time.  | 1MIN - 30MIN or OFF ( <b>6MIN</b> )  |
| 52 [TX.LED]   | Enables/Disables the TX LED while the radio is transmitting.                              | <b>LED. ON</b> / LED.OFF   |
| 53 [TXSAVE]   | Enables/Disables the Transmitter Battery Saver.   | <b>SAV.OFF</b> / SAV. ON   |
| 54 [VFO.BND]  | Enables or disables the VFO band edge limiting for the current band.                      | <b>BAND</b> / ALL  |
| 55 [WID.NAR]  | Select Wide (±5 kHz) or Narrow (±2.5 kHz) TX Deviation.                                   | <b>WIDE</b> / NARROW   |
| 56 [WX ALT]   | Enables/Disables the Weather Alert Scan feature.  | <b>ALT.OFF</b> / ALT. ON   |

※: Depends on the transceiver version.

# SET (MENU) MODE

## REPEATER SETTING

Enables/Disables the Automatic Repeater Shift function.  
Sets the Repeater Shift Direction.  
Sets the magnitude of the repeater Shift.

| SET MODE ITEM | AVAILABLE VALUES (DEFAULT)     |
|---------------|--------------------------------|
| 4 [ARS]       | ARS. ON / ARS. OFF             |
| 38 [RPT.MOD]  | RPT. OFF / RPT. - / RPT. + (X) |
| 45 [SHIFT]    | 0.00 - 99.95 MHz (X)           |

## CTCSS/DSC/DTMF SETTING

Selects the number of CTCSS/DCS Bell ringer repetitions.  
Setting of the DCS code.  
Enables/Disables "Inverted" DCS code decoding.  
Setting of the DTMF Autodialer Delay Time.

| SET MODE ITEM | AVAILABLE VALUES (DEFAULT)                    |
|---------------|---|
| 7 [BELL]      | OFF / 1T / 3T / 5T / 8T / CONT                |
| 13 [DCS.COD]  | 104 standard DCS codes (023)                  |
| 14 [DCS.N/R]  | T/RX N, RX R, TX R, T/RX R                    |
| 15 [DT DLY]   | 50MS / 100MS / 250MS / 450MS / 750MS / 1000MS |

Setting of the DTMF Autodialer Sending Speed.  
Programming of the DTMF Autodialer.  
Enables/Disables split CTCSS/DCS coding.  
Selects the Tone Encoder and/or Decoder mode.

|              |                                 |
|--------------|---------------------------------|
| 16 [DT SPD]  | 50MS / 100MS                    |
| 17 [DT WRT]  | -                               |
| 47 [SPLIT]   | SPL. OFF / SPL. ON              |
| 48 [SQL.TYP] | OFF / TONE / TSQ / REV TN / DCS |

Setting of the CTCSS Tone Frequency.

|             |                                  |
|-------------|----------------------------------|
| 50 [TN FRQ] | 50 standard CTCSS tones (100 Hz) |
|-------------|----------------------------------|

## ARTS SETTING

Selects the Beep option during ARTS operation.  
Selects the Polling Interval during ARTS operation.  
Enables/disables the CW identifier during ARTS operation.  
Programs and activates the CW Identifier (used during ARTS operation).

| SET MODE ITEM | AVAILABLE VALUES (DEFAULT) |
|---------------|----------------------------|
| 2 [AR BEP]    | INRANG / ALWAYS / OFF      |
| 3 [AR INT]    | 25 SEC / 15 SEC            |
| 10 [CWID]     | TX OFF / TX ON             |
| 11 [CW WRT]   | -                          |

## MEMORY SETTING

Toggles the display indication between "frequency" and the channel's "Alpha/Numeric Tag."  
Stores Alpha-Numeric "Tags" for the Memory channels.

| SET MODE ITEM | AVAILABLE VALUES (DEFAULT) |
|---------------|----------------------------|
| 27 [NAME]     | FREQ / ALPHA               |
| 28 [NM WRT]   | -                          |

## SCAN SETTING

Selects the Scan Resume mode.  
Enables/disables the Priority Revert feature.  
Selects the Memory Scan channel-selection mode.  
Enables/Disables the Scan lamp while paused.  
Selects the Memory Scan "Skip" channel-selection mode.  
Enables/Disables the Weather Alert Scan feature.

| SET MODE ITEM | AVAILABLE VALUES (DEFAULT) |
|---------------|----------------------------|
| 35 [RESUME]   | BUSY / HOLD / TIME         |
| 39 [PRI.RVT]  | RVT.OFF / RVT. ON          |
| 43 [SCN MD]   | ONLY / MEM                 |
| 44 [SCN.LMP]  | ON / OFF                   |
| 46 [SKIP]     | OFF / SKIP / ONLY          |
| 56 [WX ALT]   | ALT.OFF / ALT. ON          |

## POWER SAVER SETTING

Selects the Receive-mode Battery Saver interval ("sleep" ratio).  
Enables/Disables the Transmitter Battery Saver.

| SET MODE ITEM | AVAILABLE VALUES (DEFAULT)                 |
|---------------|--|
| 41 [RXSAVE]   | 200 MS / 300 MS / 500 MS / 1 S / 2 S / OFF |
| 53 [TXSAVE]   | SAV.OFF / SAV. ON                          |

## WIRES™ SETTING

Selects the Internet Link Connection mode.  
Selects the Access Number (DTMF digit) for WIRES™ operation.  
Selects the memory register for an Access Number (DTMF digit) for non-WIRES™.

| SET MODE ITEM | AVAILABLE VALUES (DEFAULT)  |
|---------------|-----------------------------|
| 21 [I NET]    | INT.OFF / INT.COD / INT.MEM |
| 22 [INT CD]   | CODE 0 - CODE 9 (CODE 1)    |
| 23 [INT MR]   | d1 - d9                     |

X: Depends on the transceiver version.

# SET (MENU) MODE

| <b>EAI/EPCS SETTING</b>  | <b>SET MODE ITEM</b> | <b>AVAILABLE VALUES (DEFAULT)</b>  |
|--|----------------------|--|
| Enables/Disables the Emergency Automatic ID (EAI) Feature.                             | 18 [EAI]             | INT. 1M - INT. 50M /<br>CON. 1M - CON.50M / <b>OFF</b>                                 |
| Enables/disables the Enhanced CTCSS Paging & Code Squelch function.                    | 29 [PAGER]           | <b>PAG.OFF</b> / PAG. ON   |
| Enables/disables the Answer Back function of the Enhanced CTCSS Paging & Code Squelch. | 30 [PAG.ABK]         | <b>ABK.OFF</b> / ABK. ON   |
| Setting the Receiver Pager Code for the Enhanced CTCSS Paging & Code Squelch.          | 31 [PAG.CDR]         | (05_47)  |
| Setting the Transmitting Pager Code for the Enhanced CTCSS Paging & Code Squelch.      | 32 [PAG.CDT]         | (05_47)  |
| <b>SWITCH/KNOB SETTING</b>   | <b>SET MODE ITEM</b> | <b>AVAILABLE VALUES (DEFAULT)</b>  |
| Enables/Disables the beeper.   | 6 [BEEP]             | <b>KEY+SC</b> / KEY / OFF  |
| Selects the LCD/Keypad Lamp mode.  | 24 [LAMP]            | <b>KEY</b> / 5SEC / TOGGLE   |
| Selects the Control Locking lockout combination.                                       | 25 [LOCK]            | LK KEY / LKDIAL / <b>LK K+D</b> / LK<br>PTT / LK P+K / LK P+D / LK ALL                 |
| Selects the MONI switch function.  | 26 [M/T-CL]          | <b>MONI</b> / T-CALL   |
| Selects the function of the [HM/RV] key.   | 36 [REV/HM]          | <b>&lt;REV&gt;</b> / <HOME>  |
| <b>MISCELLANEOUS SETTING</b>   | <b>SET MODE ITEM</b> | <b>AVAILABLE VALUES (DEFAULT)</b>  |
| Setting of the Automatic Power-Off feature.  | 1 [APO]              | <b>OFF</b> / 0.5H - 12.0 H   |
| Enables/Disables the Busy Channel Lock-Out feature.                                    | 5 [BCLO]             | <b>BCL. ON</b> / <b>BCL.OFF</b>  |
| Enables/Disables the BUSY LED while the Squelch is open.                               | 8 [BSY.LED]          | <b>LED. ON</b> / LED.OFF   |
| Shifting of the CPU clock frequency.   | 9 [CLK.SFT]          | <b>SFT.OFF</b> / SFT. ON   |
| Indicates the DC Supply Voltage.   | 12 [DC VLT]          | -  |
| Enables/Disables the Band-edge beeper while selecting the frequency via the DIAL knob. | 19 [EDG.BEP]         | <b>BEP.OFF</b> / BEP. ON   |
| Selects the alarm(s) utilized when the Emergency function is engaged.                  | 20 [EMG S]           | EMG.BEP / EMG.LMP / <b>EMG.B+L</b> /<br>EMG.CWT / EMG.C+B /<br>EMG.C+L / EMG.ALL / OFF |
| Enables/disables the Password feature.   | 33 [PSWD]            | <b>PWD.OFF</b> / PWD. ON   |
| Stores the password.   | 34 [PSWD W]          | -  |
| Adjusts the RF Squelch threshold level.  | 37 [RF SQL]          | S-1 / S-2 / S-3 / <b>S-4</b> / S-5 / S-6 /<br>S-8 / S-FULL / <b>OFF</b>                |
| Selects the receiving mode.  | 40 [RX MOD]          | <b>AUTO</b> / FM / AM  |
| Selects the Smart Search Sweep mode.   | 42 [S SRCH]          | <b>SINGLE</b> / CONT   |
| Setting of the synthesizer steps.  | 49 [STEP]            | 5 / 10 / 12.5 / 15 / 20 / 25 /<br>50 / 100 kHz, or <b>AUTO</b>                         |
| Setting of the TOT time  | 51 [TOT]             | 1MIN - 30MIN or OFF ( <b>6MIN</b> )  |
| Enables/Disables the TX LED while the radio is transmitting.                           | 52 [TX.LED]          | <b>LED. ON</b> / LED.OFF   |
| Enables or disables the VFO band edge limiting for the current band.                   | 54 [VFO.BND]         | <b>BAND</b> / ALL  |
| Select Wide (±5 kHz) or Narrow (±2.5 kHz) TX Deviation.                                | 55 [WID.NAR]         | <b>WIDE</b> / NARROW   |

# SET (MENU) MODE

---

## Set Mode Item 1 [APO]

**Function:** Setting of the Automatic Power-Off feature.

**Available Values:** OFF/0.5H - 12.0 H in 0.5 hour multiples

**Default:** OFF

## Set Mode Item 2 [AR BEP]

**Function:** Selects the Beep option during ARTS operation.

**Available Values:** INRANG/ALWAYS/OFF

**Default:** INRANG

**INRANG:** Beeps sound only when the radio first detects that you are within range.

**ALWAYS:** Beeps sound every time a polling transmission is received from the other station (every 15 or 25 seconds when in range).

**OFF:** No alert beeps sound.

## Set Mode Item 3 [AR INT]

**Function:** Selects the Polling Interval during ARTS operation.

**Available Values:** 25 SEC/15 SEC

**Default:** 25SEC

## Set Mode Item 4 [ARS]

**Function:** Enables/Disables the Automatic Repeater Shift function.

**Available Values:** ARS. ON/ARS.OFF

**Default:** ARS. ON

## Set Mode Item 5 [BCLO]

**Function:** Enables/Disables the Busy Channel Lock-Out feature.

**Available Values:** BCL. ON/BCL.OFF

**Default:** BCL.OFF

## Set Mode Item 6 [BEEP]

**Function:** Enables/Disables the beeper.

**Available Values:** KEY+SC/KEY/OFF

**Default:** KEY+SC

**KEY+SC:** The beeper sounds when you press any key, or when the scanner stops.

**KEY:** The beeper sounds when you press any key.

**OFF:** Beeper is disabled.

## Set Mode Item 7 [BELL]

**Function:** Selects the number of CTCSS/DCS Bell ringer repetitions.

**Available Values:** OFF/1T/3T/5T/8T/CONT (Continuous ringing)

**Default:** OFF



# SET (MENU) MODE

## Set Mode Item 8 [BSY.LED]

**Function:** Enables/Disables the **BUSY** LED while the Squelch is open.

**Available Values:** LED. ON/LED.OFF

**Default:** LED. ON

## Set Mode Item 9 [CLK.SFT]

**Function:** Shifting of the CPU clock frequency.

**Available Values:** SFT.OFF/SFT. ON

**Default:** SFT.OFF

This function is only used to move a spurious response “birdie,” should it fall on a desired frequency.

## Set Mode Item 10 [CWID]

**Function:** Enables/disables the CW identifier during ARTS operation.

**Available Values:** TX OFF/TX ON

**Default:** TX OFF

## Set Mode Item 11 [CW WRT]

**Function:** Programs and activates the CW Identifier (used during ARTS operation).

See page 53 for details.

## Set Mode Item 12 [DC VLT]

**Function:** Indicates the DC Supply Voltage.

## Set Mode Item 13 [DCS.COD]

**Function:** Setting of the DCS code.

**Available Values:** 104 standard DCS codes

**Default:** DCS.023

## Set Mode Item 14 [DCS.N/R]

**Function:** Enables/Disables “Inverted” DCS code decoding.

**Available Values:** T/RX N, RX R, TX R,  
T/RX R

**Default:** T/RX N

| DCS CODE |     |     |     |     |     |     |     |     |     |  |
|----------|-----|-----|-----|-----|-----|-----|-----|-----|-----|--|
| 023      | 025 | 026 | 031 | 032 | 036 | 043 | 047 | 051 | 053 |  |
| 054      | 065 | 071 | 072 | 073 | 074 | 114 | 115 | 116 | 122 |  |
| 125      | 131 | 132 | 134 | 143 | 145 | 152 | 155 | 156 | 162 |  |
| 165      | 172 | 174 | 205 | 212 | 223 | 225 | 226 | 243 | 244 |  |
| 245      | 246 | 251 | 252 | 255 | 261 | 263 | 265 | 266 | 271 |  |
| 274      | 306 | 311 | 315 | 325 | 331 | 332 | 343 | 346 | 351 |  |
| 356      | 364 | 365 | 371 | 411 | 412 | 413 | 423 | 431 | 432 |  |
| 445      | 446 | 452 | 454 | 455 | 462 | 464 | 465 | 466 | 503 |  |
| 506      | 516 | 523 | 526 | 532 | 546 | 565 | 606 | 612 | 624 |  |
| 627      | 631 | 632 | 654 | 662 | 664 | 703 | 712 | 723 | 731 |  |
| 732      | 734 | 743 | 754 | -   | -   | -   | -   | -   | -   |  |

## Set Mode Item 15 [DT DLY]

**Function:** Setting of the DTMF Autodialer Delay Time.

**Available Values:** 50MS/100MS/250MS/450MS/750MS/1000MS

**Default:** 450MS

## Set Mode Item 16 [DT SPD]

**Function:** Setting of the DTMF Autodialer Sending Speed.

**Available Values:** 50MS (high speed)/100MS (low speed)

**Default:** 50MS

# SET (MENU) MODE

---

## Set Mode Item 17 [DT WRT]

**Function:** Programming of the DTMF Autodialer.

See page 54 for details.

## Set Mode Item 18 [EAI]

**Function:** Enables/Disables the Emergency Automatic ID (EAI) Feature.

**Available Values:**

INT. 1M - INT.10M, INT.15M, INT.20M, INT.30M, INT.40M, INT. 50M,

CON. 1M - CON.10M, CON.15M, CON.20M, CON.30M, CON.40M, CON. 50M, and

OFF

**Default:** OFF

## Set Mode Item 19 [EDG.BEP]

**Function:** Enables/Disables the Band-edge beeper while selecting the frequency via the **DIAL** knob.

**Available Values:** BEP.OFF/ BEP. ON

**Default:** BEP.OFF

## Set Mode Item 20 [EMG S]

**Function:** Selects the alarm(s) utilized when the Emergency function is engaged.

**Available Values:** EMG.BEP/EMG.LMP/EMG.B+L/EMG.CWT/EMG.C+B/EMG.C+L/  
EMG.ALL/OFF

**Default:** EMG.B+L

**EMG.BEP:** Loud “Alarm” sounds.

**EMG.LMP:** The LCD/Keypad lamp flashes.

**EMG.B+L:** Loud “Alarm” sounds and the LCD/Keypad lamp flashes.

**EMG.CWT:** Transmits the Morse Code “SOS” (••• – – –•••) message on the air beginning one minute after activation of the Emergency function.

**EMG.C+B:** Loud “Alarm” sounds and the Morse Code “SOS” (••• – – –•••) message is transmitted on the air beginning one minute after activation of the Emergency function.

**EMG.C+L:** The LCD/Keypad lamp flashes, and the Morse Code “SOS” (••• – – –•••) message is transmitted on the air beginning one minute after activation of the Emergency function.

**EMG.ALL:** All of the above are activated.

**OFF:** Disables the Emergency function. The Emergency function also cannot be engaged, by pressing and holding in the [**4(RPT)**] key, if this Menu is set to “OFF.”

When the radio is set to the EMG.CWT, EMG.C+B, EMG.C+L, or EMG.ALL mode, the radio will be instructed to send “DE (your callsign)” after the sending of the SOS message, if your callsign is entered via Set Mode Item 11: CW WRT.

## **Set Mode Item 21 [I NET]**

**Function:** Selects the Internet Link Connection mode.

**Available Values:** INT.OFF/INT.COD/INT.MEM

**Default:** INT.OFF

**INT.OFF:** Disables the Internet Link Connection mode.

**INT.COD:** Sets up the Internet Link Connection mode for WIRES™ access.

**INT.MEM:** Sets up the Internet Link Connection mode for other (DTMF string) Internet Link System access.

## **Set Mode Item 22 [INT CD]**

**Function:** Selects the Access Number (DTMF digit) for WIRES™ operation.

**Available Values:** CODE 0 - CODE 9

**Default:** CODE 1

## **Set Mode Item 23 [INT MR]**

**Function:** Selects the memory register for an Access Number (DTMF code) for non-WIRES™ Internet Link System access.

**Available Values:** d1 - d9

**Default:** d1

## **Set Mode Item 24 [LAMP]**

**Function:** Selects the LCD/Keypad Lamp mode.

**Available Values:** KEY/5SEC/TOGGLE

**Default:** KEY

**KEY:** Illuminates the Keypad/LCD for five seconds when you rotate the **DIAL** knob or press any key or switch (except the **PTT** switch).

**5SEC:** Illuminates the Keypad/LCD for five seconds when you press the **LAMP** switch momentarily.

**TOGGLE:** Toggles the Keypad/LCD lamp on and off when you press the **LAMP** switch repeatedly.

## **Set Mode Item 25 [LOCK]**

**Function:** Selects the Control Locking lockout combination.

**Available Values:** LK KEY/LKDIAL/LK K+D/LK PTT/LK P+K/LK P+D/LK ALL

**Default:** LK K+D

**Note:** “K” = “Key;” “D” = “Dial;” and “P” = “PTT.”

# SET (MENU) MODE

---

## Set Mode Item 26 [M/T-CL]

**Function:** Selects the **MONI** switch (just below the **PTT** switch) function.

**Available Values:** MONI/T-CALL

**Default:** MONI

**MONI:** Pressing the **MONI** switch causes the Noise/Tone Squelch to be over-ridden, allowing you to listen for weak (or non-encoded) signals.

**T-CALL:** Pressing the **MONI** switch activates a 1750-Hz burst tone, used for repeater access in many countries (especially in Europe).

## Set Mode Item 27 [NAME]

**Function:** Toggles the display indication between “frequency” and the channel’s “Alpha/Numeric Tag.”

**Available Values:** FREQ/ALPHA

**Default:** FREQ

## Set Mode Item 28 [NM WRT]

**Function:** Stores Alpha-Numeric “Tags” for the Memory channels.

See page 30 for details.

## Set Mode Item 29 [PAGER]

**Function:** Enables/disables the Enhanced CTCSS Paging & Code Squelch function.

**Available Values:** PAG.OFF/PAG. ON

**Default:** PAG.OFF

## Set Mode Item 30 [PAG.ABK]

**Function:** Enables/disables the Answer Back function of the Enhanced CTCSS Paging & Code Squelch.

**Available Values:** ABK.OFF/ABK. ON

**Default:** ABK.OFF

## Set Mode Item 31 [PAG.CDR]

**Function:** Setting the Receiver Pager Code for the Enhanced CTCSS Paging & Code Squelch.

See page 44 for details.

## Set Mode Item 32 [PAG.CDT]

**Function:** Setting the Transmitting Pager Code for the Enhanced CTCSS Paging & Code Squelch.

See page 44 for details.

## Set Mode Item 33 [PSWD]

**Function:** Enables/disables the Password feature.

**Available Values:** PWD.OFF/PWD. ON

**Default:** PWD.OFF

## **Set Mode Item 34 [PSWD W]**

**Function:** Stores the password.

Available entries are 0-9, A, B, C, D, E (substitute for “\*”), and F (substitute for “#”)

## **Set Mode Item 35 [RESUME]**

**Function:** Selects the Scan Resume mode.

**Available Values:** BUSY/HOLD/TIME

**Default:** BUSY

**BUSY:** The scanner will hold until the signal disappears, then will resume when the carrier drops.

**HOLD:** The scanner will stop when a signal is received, and will not restart.

**TIME:** The scanner will hold for the five seconds, then resume whether or not the other station is still transmitting.

## **Set Mode Item 36 [REV/HM]**

**Function:** Selects the function of the [HM/RV] key.

**Available Values:** <REV> / <HOME>

**Default:** <REV>

**<REV>:** Pressing the [HM/RV] key reverses the transmit and receive frequencies during repeater operation.

**<HOME>:** Pressing the [HM/RV] key instantly recalls a favorite “Home” channel.

## **Set Mode Item 37 [RF SQL]**

**Function:** Adjusts the RF Squelch threshold level.

**Available Values:** S-1/S-2/S-3/S-4/S-5/S-6/S-8/S-FULL/OFF

**Default:** OFF

## **Set Mode Item 38 [RPT.MOD]**

**Function:** Sets the Repeater Shift Direction.

**Available Values:** RPT.OFF/RPT. -/RPT. +

**Default:** Depends on the transceiver version, as well as the setting of Set Mode Item 4: ARS.

## **Set Mode Item 39 [PRI.RVT]**

**Function:** Enables/disables the Priority Revert feature.

**Available Values:** RVT.OFF/RVT. ON

**Default:** RVT.OFF

See page 42 for details.

## **Set Mode Item 40 [RX MOD]**

**Function:** Selects the receiving mode.

**Available Values:** AUTO/FM/AM

**Default:** AUTO (Mode automatically changes according to operating frequency)

# SET (MENU) MODE

---

## **Set Mode Item 41 [RXSAVE]**

**Function:** Selects the Receive-mode Battery Saver interval (“sleep” ratio)

**Available Values:** 200 MS(1:1)/300 MS(1:1.5)/500 MS(1:2.5)/1 S(1:5)/2 S(1:10)/OFF

**Default:** 200 MS

## **Set Mode Item 42 [S SRCH]**

**Function:** Selects the Smart Search Sweep mode.

**Available Values:** SINGLE/CONT

**Default:** SINGLE

**SINGLE:** The transceiver sweeps the current band once in each direction, starting on the current frequency. All channels where activity is present (up to 15 in each direction) are loaded into the Smart Search memories. Whether or not all 31 memories are filled, the search stops after one sweep in each direction.

**CONT:** The transceiver makes a sweep in each direction as with the “SINGLE” mode, but if all 31 channels are not filled after the first sweep, the radio continues sweeping until they *are* all filled.

## **Set Mode Item 43 [SCN MD]**

**Function:** Selects the Memory Scan channel-selection mode.

**Available Values:** ONLY/MEM

**Default:** MEM

**ONLY:** The scanner will only scan channels that are flagged (Preferential Scan List).

**MEM:** The scanner will “skip” the flagged channels during scanning.

## **Set Mode Item 44 [SCN.LMP]**

**Function:** Enables/Disables the Scan lamp while paused.

**Available Values:** ON/OFF

**Default:** ON

## **Set Mode Item 45 [SHIFT]**

**Function:** Sets the magnitude of the repeater Shift.

**Available Values:** 0.00 - 99.95 MHz (50 kHz increments)

**Default:** Depends on the operating band and transceiver version.

## **Set Mode Item 46 [SKIP]**

**Function:** Selects the Memory Scan “Skip” channel-selection mode.

**Available Values:** OFF/SKIP/ONLY

**Default:** OFF

**SKIP:** The scanner will “skip” the flagged channels during scanning.

**ONLY:** The scanner will only scan channels that are flagged (Preferential Scan List).

**OFF:** All memory channels will be scanned (the “flag” will be ignored).

## **Set Mode Item 47 [SPLIT]**

**Function:** Enables/Disables split CTCSS/DCS coding.

**Available Values:** SPL.OFF/SPL. ON

**Default:** SPL.OFF

When this Set Mode Item is set to “SPL. ON,” you will see the following additional parameters after the “DCS” parameter while configuring Set Mode Item 48: SQL.TYP.

**D:** DCS Encode only.

**T DCS:** Encodes a CTCSS tone and Decodes a DCS code.

**D TSQL:** Encodes a DCS code and Decodes a CTCSS tone.

Select the desired operating mode from the selections shown above.

## **Set Mode Item 48 [SQL.TYP]**

**Function:** Selects the Tone Encoder and/or Decoder mode.

**Available Values:** OFF/TONE/TSQL/REV TN/DCS

**Default:** OFF

**TONE:** CTCSS Encoder

**TSQL:** CTCSS Encoder/Decoder

**REV TN:** Reverse CTCSS Decoder (Mutes receiver when matching tone is received)

**DCS:** Digital Coded Encoder/Decoder

**Note:** See also Set Mode Item 47: SPLIT regarding additional selections available during “Split Tone” operation.

## **Set Mode Item 49 [STEP]**

**Function:** Setting of the synthesizer steps.

**Available Values:** 5/10/12.5/15/20/25/50/100 kHz, or AUTO

**Default:** AUTO (Step automatically changes according to operating frequency.)

## **Set Mode Item 50 [TN FRQ]**

**Function:** Setting of the CTCSS Tone Frequency.

**Available Values:** 50 standard CTCSS tones

**Default:** 100.0 Hz

| CTCSS TONE FREQUENCY (Hz) |       |       |       |       |       |
|---------------------------|-------|-------|-------|-------|-------|
| 67.0                      | 69.3  | 71.9  | 74.4  | 77.0  | 79.7  |
| 82.5                      | 85.4  | 88.5  | 91.5  | 94.8  | 97.4  |
| 100.0                     | 103.5 | 107.2 | 110.9 | 114.8 | 118.8 |
| 123.0                     | 127.3 | 131.8 | 136.5 | 141.3 | 146.2 |
| 151.4                     | 156.7 | 159.8 | 162.2 | 165.5 | 167.9 |
| 171.3                     | 173.8 | 177.3 | 179.9 | 183.5 | 186.2 |
| 189.9                     | 192.8 | 196.6 | 199.5 | 203.5 | 206.5 |
| 210.7                     | 218.1 | 225.7 | 229.1 | 233.6 | 241.8 |
| 250.3                     | 254.1 | –     | –     | –     | –     |

## **Set Mode Item 51 [TOT]**

**Function:** Setting of the TOT time

**Available Values:** 1MIN - 30MIN or OFF

**Default:** 6MIN (minutes)

The time-out timer shuts off the transmitter after continuous transmission of the programmed time.

# SET (MENU) MODE

---

## **Set Mode Item 52 [TX.LED]**

**Function:** Enables/Disables the TX LED while the radio is transmitting.

**Available Values:** LED. ON/LED.OFF

**Default:** LED. ON

## **Set Mode Item 53 [TXSAVE]**

**Function:** Enables/Disables the Transmitter Battery Saver.

**Available Values:** SAV.OFF/ SAV. ON

**Default:** SAV.OFF

## **Set Mode Item 54 [VFO.BND]**

**Function:** Enables or disables the VFO band edge limiting for the current band.

**Available Values:** BAND/ALL

**Default:** BAND

**BAND:** When the VFO frequency reaches the high band edge of the current band, the VFO frequency will jump to the low band edge of the current band (or vice versa).

**ALL:** When the VFO frequency reaches the high edge of the current band, the VFO frequency will jump to the low band edge of the next band (or vice versa).

## **Set Mode Item 55 [WID.NAR]**

**Function:** Select Wide ( $\pm 5$  kHz) or Narrow ( $\pm 2.5$  kHz) TX Deviation.

**Available Values:** WIDE/NARROW

**Default:** WIDE

**Note:** If “Narrow” is selected, the receiver audio level is increased slightly to compensate for the reduced deviation. The receiver IF filter bandwidth is not changed via this setting.

## **Set Mode Item 56 [WX ALT]**

**Function:** Enables/Disables the Weather Alert Scan feature.

**Available Values:** ALT.OFF/ALT. ON

**Default:** ALT. OFF



## General

|   |  |
|---|--|
| <b>Frequency Ranges:</b><br>(Cellular Blocked)  | RX 108 - 137 MHz (Air Band),<br>137 - 520 MHz (AM/FM),<br>700 - 999.990 MHz (FM)<br>TX 144-148 MHz, 430-450 MHz  |
| <b>Channel Steps:</b>                           | 5/10/12.5/15/20/25/50/100 kHz  |
| <b>Frequency Stability:</b>                     | ±5 ppm @ 14 °F to 140 °F (−10 °C to +60 °C)  |
| <b>Repeater Shift:</b>                          | ±600 kHz (144 MHz), ±1.6/5.0/7.6 MHz (430 MHz)   |
| <b>Emission Type:</b>                           | F2D, F3E   |
| <b>Antenna Impedance:</b>                       | 50 Ω   |
| <b>Supply Voltage:</b><br>(Negative Ground)     | Nominal: 7.2 V DC, Negative Ground<br>Operating: 6.0 ~ 16.0 V DC (EXT DC Jack)<br>11.0 ~ 16.0 V DC (EXT DC Jack with Charging)   |
| <b>Current Consumption:</b><br>(Approx. @7.2 V) | 125 mA (Receive)<br>45 mA (144 MHz, Standby, Saver Off)<br>47 mA (430 MHz, Standby, Saver Off)<br>19 mA (Standby, Saver On)<br>0.8 mA (Auto Power Off)<br>1.5 A (5 W TX, 144 MHz)<br>1.6 A (5 W TX, 430 MHz) |
| <b>Operating Temperature:</b>                   | −4 °F to 140 °F (−20 °C to +60 °C)   |
| <b>Case Size:</b>                               | 2.3" (W) x 4.3" (H) x 1.2" (D) (58 x 109 x 30 mm)<br>(W/O knob, antenna, and belt clip)  |
| <b>Weight:</b>                                  | 13.05 Oz (370 g) with FNB-83, and antenna  |

## Transmitter

|                              |  |
|------------------------------|--|
| <b>RF Power Output:</b>      | 5.0 W (High) / 2.0 W (Middle) / 0.5 W (Low) (Approx.)                              |
| <b>Modulation Type:</b>      | Variable Reactance F2D, F3E  |
| <b>Maximum Deviation:</b>    | ±5.0 kHz (F2D, F3E)  |
| <b>Spurious Emission:</b>    | At least 60 dB down (@ High and Middle power)<br>At least 40 dB down (@ Low power) |
| <b>Microphone Impedance:</b> | 2 kΩ   |

## Receiver

|  |   |
|--|---|
| <b>Circuit Type:</b>                       | Double-Conversion Superheterodyne   |
| <b>Intermediate Frequencies:</b>           | 1st: 47.25 MHz, 2nd: 450 kHz  |
| <b>Sensitivity :</b><br>(Cellular Blocked) | 0.8 μV TYP for 10 dB SN (108-137 MHz, AM)<br>0.2 μV for 12 dB SINAD (137-140 MHz, FM)<br>0.16 μV for 12 dB SINAD (140-150 MHz, FM)<br>0.2 μV for 12 dB SINAD (150-174 MHz, FM)<br>0.3 μV TYP for 12 dB SINAD (174-300 MHz, FM)<br>0.8 μV for 10 dB SN (300-336 MHz, AM)<br>0.25 μV for 12 dB SINAD (336-420 MHz, FM)<br>0.2 μV for 12 dB SINAD (400-470 MHz, FM)<br>0.25 μV for 12 dB SINAD (470-520 MHz, FM)<br>0.5 μV TYP for 12 dB SINAD (800-900 MHz, FM)<br>0.8 μV TYP for 12 dB SINAD (800-999.990 MHz, FM) |
| <b>Selectivity:</b>                        | 12 kHz/35 kHz (−6 dB /−60 dB)   |
| <b>AF Output:</b>                          | 400 mW @ 8 W for 10 % THD (@ 7.5 V)   |

*Specifications are subject to change without notice, and are guaranteed within the 144 and 430 MHz amateur bands only. Frequency ranges will vary according to transceiver version; check with your dealer.*

# “AUTO” MODE PRESET OPERATING PARAMETERS

| FREQUENCY RANGE (MHz) | MODE | STEP     | FREQUENCY RANGE (MHz) | MODE | STEP     |
|-----------------------|------|----------|-----------------------|------|----------|
| 108.000 - 137.000     | AM   | 25 kHz   | 174.000 - 222.000     | FM   | 50 kHz   |
| 137.000 - 144.000     | FM   | 12.5 kHz | 222.000 - 225.000     | FM   | 5 kHz    |
| 144.000 - 148.000     | FM   | 5 kHz    | 225.000 - 300.000     | FM   | 12.5 kHz |
| 148.000 - 156.000     | FM   | 12.5 kHz | 300.000 - 336.000     | AM   | 100 kHz  |
| 156.000 - 157.450     | FM   | 25 kHz   | 336.000 - 420.000     | FM   | 12.5 kHz |
| 157.450 - 160.600     | FM   | 12.5 kHz | 420.000 - 450.000     | FM   | 25 kHz   |
| 160.600 - 160.975     | FM   | 25 kHz   | 450.000 - 470.000     | FM   | 12.5 kHz |
| 160.975 - 161.500     | FM   | 12.5 kHz | 470.000 - 520.000     | FM   | 50 kHz   |
| 161.500 - 162.900     | FM   | 25 kHz   | 700.000 - 800.000     | FM   | 50 kHz   |
| 162.900 - 174.000     | FM   | 12.5 kHz | 800.000 - 999.990     | FM   | 12.5 kHz |

1. Changes or modifications to this device not expressly approved by VERTEX STANDARD could void the user's authorization to operate this device.
2. This device complies with part 15 of the FCC Rules. Operation is subject to the following two conditions: (1) This device may not cause harmful interference, and (2) this device must accept any interference including received, interference that may cause undesired operation.
3. The scanning receiver in this equipment is incapable of tuning, or readily being altered, by the User to operate within the frequency bands allocated to the Domestic public Cellular Telecommunications Service in Part 22.

#### **DECLARATION BY MANUFACTURER**

The Scanner receiver is not a digital scanner and is incapable of being converted or modified to a digital scanner receiver by any user.

**WARNING:** MODIFICATION OF THIS DEVICE TO RECEIVE CELLULAR RADIOTELEPHONE SERVICE SIGNALS IS PROHIBITED UNDER FCC RULES AND FEDERAL LAW.



Copyright 2004  
VERTEX STANDARD CO., LTD.  
All rights reserved.

Printed in Japan

No portion of this manual  
may be reproduced  
without the permission of  
VERTEX STANDARD CO., LTD.



E H O 1 7 M 1 0 1

0407F-AK