



# **INSTRUCTION MANUAL FT-780R**

**YAESU MUSEN CO., LTD.**

TOKYO JAPAN

# TABLE OF CONTENTS

	(Page)
GENERAL DESCRIPTION .....	( 1)
SPECIFICATIONS .....	( 2)
SEMICONDUCTORS/ACCESSORIES .....	( 3)
FRONT PANEL CONTROLS AND SWITCHES .....	( 4)
REAR PANEL CONNECTIONS AND SWITCHES .....	( 6)
UNDER CABINET SWITCHES .....	( 7)
INSTALLATION .....	( 8)
OPERATION .....	(10)
CIRCUIT DESCRIPTION .....	(16)
MAINTENANCE AND ALIGNMENT .....	(20)
PARTS LIST .....	(30)

# FT-780R

## MICROPROCESSOR CONTROLLED 0.7 METER ALL-MODE TRANSCEIVER



### GENERAL DESCRIPTION

The FT-780R is a revolutionary, high performance USB, LSB, FM, and CW transceiver for the most demanding 70 cm operator. Controlled by a NMOS 4-bit microprocessor, the FT-780R features full PLL synthesis in 10 Hz, 100 Hz, 1 kHz, 25 kHz (US model), and 100 kHz steps. The extremely compact size of the FT-780R makes this model particularly well suited for mobile use.

The microprocessor chip allows never-before-possible operating flexibility. As many as four memory channels may be programmed to your favorite frequencies, and by switching to the MEMORY SCAN position, all four memory channels will be scanned.

Digital display of the operating frequency is provided. The front panel meter consists of a string of bright LED's, for easy monitoring of the received signal strength and transmitter output.

The standard microphone features a PTT switch and up/down scanning controls, plus a tone call button for repeater operation.

Among the convenience features of your FT-780R are receiver offset tuning for CW and SSB, and a digitally synthesized dual VFO system. For satellite work, the transmit frequency may be varied to counter Doppler shift.

We recommend that you read this manual in its entirety, so as to derive maximum benefit from your new FT-780R, an exciting breakthrough from the communications experts . . . . Yaesu.

# SPECIFICATIONS

## GENERAL

### Frequency coverage:

\*430,00 – 439.99 MHz Lowband model

\*\*440,00 – 449.99 MHz Highband model

### Modes of operation:

SSB (USB, LSB), CW, and FM

### Synthesizer steps:

SSB, CW 10 Hz, 100 Hz, 1 kHz

FM 1 kHz, 25 kHz, 100 kHz

### Frequency stability:

±10 ppm (–10°C – +60°C)

### Power requirements:

13.8 volts DC, negative ground

### Current consumption:

DC 0.5 amps receive

DC 4.0 amps transmit

### Antenna impedance:

50 ohms

### Case size:

60 (H) × 180 (W) × 250 (D) mm

### Weight:

Approx. 3.0 kg

## TRANSMITTER

### Power input:

SSB 30 watts PEP

FM/CW 30 watts DC

### Carrier suppression (SSB):

Better than 40 dB

### Unwanted sideband suppression (SSB):

Better than 40 dB

### Spurious emission (SSB):

At least 60 dB down

### Frequency response:

400 – 2600 Hz (–6 dB)

### FM Deviation:

±5 kHz

### Microphone impedance:

600 ohms

## RECEIVER

### Sensitivity:

SSB, CW 0.5 μV for 20 dB S/N

FM 12 dB SINAD 0.35 μV

1 μV S/N 35 dB

### Selectivity:

SSB, CW 2.2 kHz at 6 dB down

4.8 kHz at 60 dB down

FM 14 kHz at 6 dB down

25 kHz at 60 dB down

### Image response:

Better than –60 dB

### Audio output impedance:

8 ohms nominal

### Audio output:

2.0 watts @ 10% THD

\* Model A, B

\*\* Model X

Model	Frequency Range (MHz)	Synthesizer Steps (Hz)						Tone Burst Frequency (Hz)	Preset Frequency (MHz)	Repeater Offset Frequency (MHz)
		SSB, CW			FM					
		S	M	F	S	M	F			
A	430.00 – 439.99	10	100	1K	1K	25K	100K	1800	435.00	±5
X	440.0 – 449.99	10	100	1K	1K	25K	100K	1800	445.00	±5
B	430.0 – 439.99	10	100	1K	1K	25K	100K	1750	433.00	±7.6

## SEMICONDUCTOR

<b>IC:</b>		3SK73Y	9	1SS53	74
HD10551	2	3SK97	1	1SS97	7
M57716	1			10D1	3
MB84024B	1	<b>Transistor:</b>		1T25	4
MC1496P	2	2SA496-O/Y	2	HZ6A-L	1
MC14002B	1	(2SB548)		HZ11B-1	1
MC14011B	2	2SA564Q	3	M1301	3
MC14069UB	2	2SA733P/Q	19	U05B	1
MC14094B	4	2SC460B	3		
MC14504B	1	2SC535B	8	<b>LED:</b>	
MC14518B	1	2SC945K	1	TLG205	2
SN16913P	3	2SC945P	37	TLG226	5
TA7612AP	1	2SC1383R	1	TLR205	2
TC5081P	2	2SC1426	1	TLR226	3
TC5082P	1	2SC1583	3	TLY226	2
TC9122P	2	2SC1815GR	4		
$\mu$ PC78L05	3	2SC2002L	1	<b>FCD:</b>	
$\mu$ PC577H	1	2SC2026	4	LD8231/F1P9C5	1
$\mu$ PC1037H	1	2SC2053	1		
$\mu$ PC2002H	1	2SC2407	1		
$\mu$ PC7808H	2	2SC2785E	3		
$\mu$ PD1511-018	1	MPS-A13	2		
<b>FET:</b>		<b>Diode:</b>			
2SK19TM-GR	3	1S188FM	7		
2SK30A-Y	1	1S1555	4		

Specifications subject to change without notice of obligation.

## ACCESSORIES

1. Microphone (M3090028) 1 ea.
2. Power Cord (T9002805) 1 ea.
3. Spare Fuses (5A) (Q0000005) 2 ea.
4. Stand (R0062300A) 1 ea.
5. Miniature Phone Plug (P0090034) 2 ea.
6. Mobile Mounting Bracket (R0062900) 1 ea.
7. TONE IN Connector (P0090174) 1 ea.
8. ACC Connector (P0090188) 1 ea.

## FRONT PANEL CONTROLS AND SWITCHES

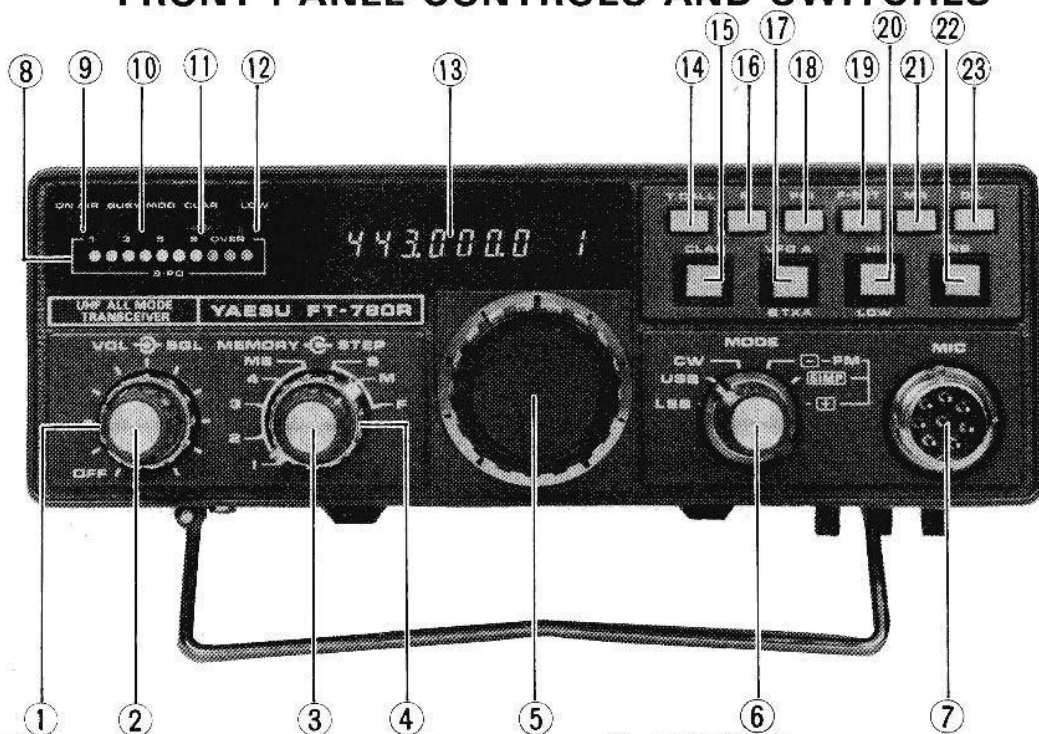

The FT-780R has been designed for ease of operation. However, the operator may not be familiar with some controls since the FT-780R utilizes modern computer technology. Be sure you thoroughly understand the function of each control and indicator before operating this equipment.

### (1) SQL

The squelch control quiets the receiver in the absence of a signal on FM. It should be set to the point where the background noise just disappears, in order to provide maximum sensitivity.

### (2) VOL

This control is the main ON/OFF switch for the transceiver, and it also sets the audio output level to the speaker. Clockwise rotation increases the audio output level.

### (3) STEP

The 3 positions of this switch control the tuning rate of the main dial, as shown in Table 1.

STEP SWITCH POSITION	MAIN DIAL FREQUENCY COVERAGE PER STEP	
	SSB/CW	FM
S	10 Hz	1 kHz
M	100 Hz	25 kHz
F	1 kHz	100 kHz

Table 1

\* USA Model (Model A)

### (4) MEMORY

This switch selects the MS mode (Memory Scan) or one of the four frequencies that the operator has programmed into memory. Memory scan control is exercised via the UP/DOWN switches on the microphone.

### (5) MAIN TUNING KNOB

The tuning knob is used to control the receive and transmit frequencies over the entire 0.7 meter amateur band. It is activated when the DIL button is pushed.

When the transceiver is initially turned on, the display will indicate \*435.000.0 MHz, and the dial may be turned from that point to the desired operating frequency.

### (6) MODE

This switch selects the mode of operation: USB (upper sideband), LSB (lower sideband), CW (code operation), and FM (frequency modulation). Selection of simplex or \*±5 MHz repeater shift is also provided on this switch.

### (7) MIC

The MIC jack is used for microphone input, PTT control, and scanner control lines.

### (8) S/PO

A string of LEDs provides indication of signal strength and relative power output.

### (9) ON AIR

This indicator lights up during transmission.

### (10) BUSY/MOD

This indicator has a dual function: it will light up when the channel is occupied, or indicate modulation during FM transmissions.

### (11) CLAR Indicator

This lamp lights when the clarifier switch is pushed.

### (12) LOW

This lamp lights when the HI/LOW switch is in the LOW position.

### (13) Digital Display

The digital display indicates the operating frequency. In the priority mode, the character "P" will be illuminated at the far right-hand side of the window. Also, the memory channel in use will be indicated for easy reference.

### (14) T.CALL

When this switch is pushed, the PTT line will close, and a 1750 Hz or 1800 Hz tone will be transmitted for accessing repeaters.

### (15) CLAR

The clarifier switch allows  $\pm 10$  kHz offset of the receive frequency from the dial or memory frequency. Clarifier tuning is accomplished via the main tuning dial. When the CLAR switch is pushed, the scanning step selector should be set to 10 Hz or 100 Hz; if not, control will be returned to the main dial, with the clarifier being disabled.

### (16) M (Memory)

This switch is used for programming a frequency into memory.

### (17) VFO A/B TXA

This switch, when pressed, allows split operation using the two internal VFOs.

### (18) PRI

While operating in the dial tuning mode, the PRIORITY switch allows scanning of the main dial and one of the memorized frequencies every 7

seconds. The SCAN switch controls the stopping of the scanner on a busy or clear channel.

### (19) F.SET

This switch, when pressed, clears all digits of the operating frequency below the step frequency you are using.

### (20) HI/LOW

This switch, when pressed, reduces the transmitter power from 10 watts to 1 watt RF output.

### (21) MR (Memory Recall)

This button transfers frequency control from the main dial to the memory channels.

### (22) NB (Noise Blanker)

This switch, when pressed, activates the noise blanker for minimizing pulse-type noise.

### (23) DIL (Dial)

This switch, when pressed, transfers frequency control from the memory channels to the main tuning dial.

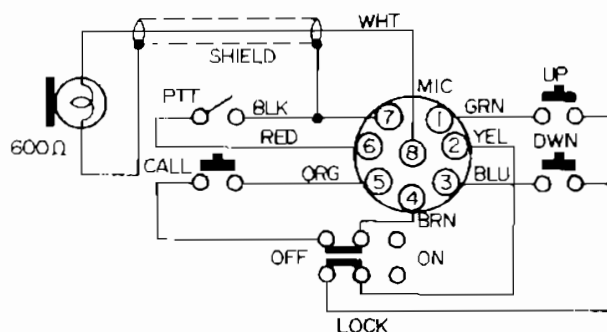
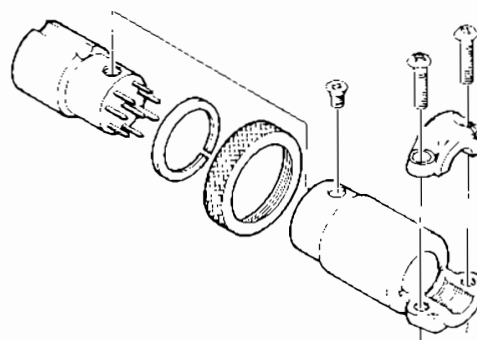

YM-40 MICROPHONE CONNECTIONS

## REAR PANEL CONNECTIONS AND SWITCH

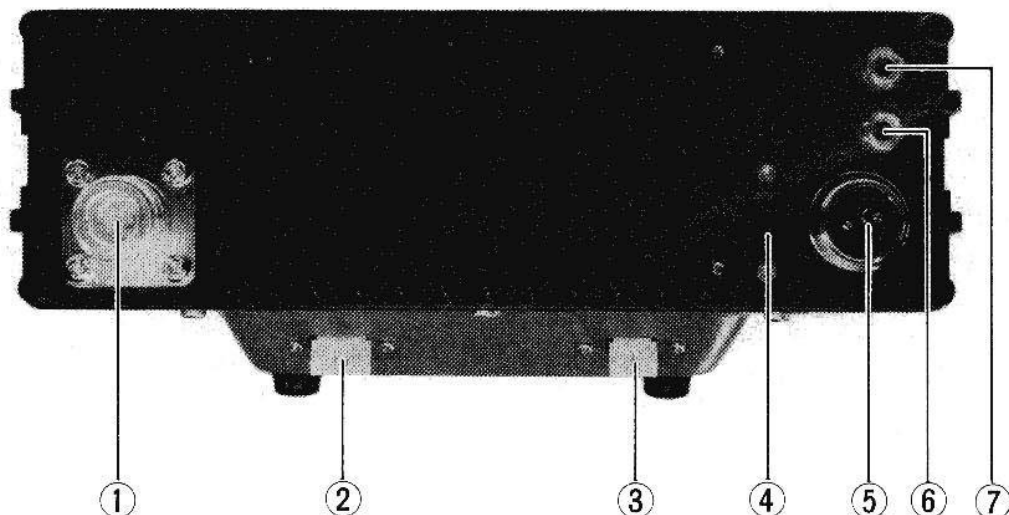

### (1) ANT

This is the main antenna connector.

### (2) TONE IN CONNECTOR

This connector is provided for the optional external FTS-64E Tone Encoder, which synthesizes 32 CTCSS or tone burst frequencies.

### (3) ACC CONNECTOR

This connector supplies output for the external S/PO meter and the stand-by control line for the external control (TX-GND).

### (4) BACKUP

When this switch is placed in the ON position, and DC power is still connected to the POWER connector, the memory circuit will still be held in operating condition. If DC power is removed, though, the memorized frequency will be lost.

### (5) POWER

This receptacle accommodates the power cord. A fuse rated at 5 amps is located in the power cord.

### (6) EXT SP

This is a miniature phone jack for connection to an

external speaker. Insertion of a plug into this jack automatically cuts off the internal speaker.

### (7) KEY

This is the key jack for CW operation. The key-up voltage is +8V, while the key-down current is approximately 1mA.

#### WARNING

WHEN REPLACING FUSES, BE CERTAIN TO USE A FUSE OF 5 AMP RATING. OUR WARRANTY DOES NOT COVER DAMAGE CAUSED BY USE OF AN IMPROPER FUSE.

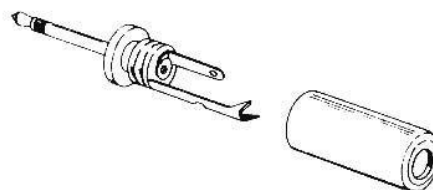
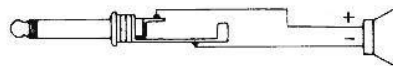

#### EXTERNAL SPEAKER CONNECTIONS

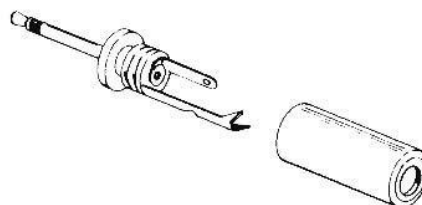
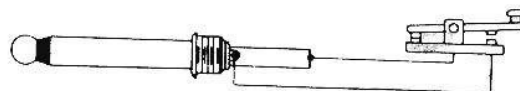

#### KEY CONNECTIONS

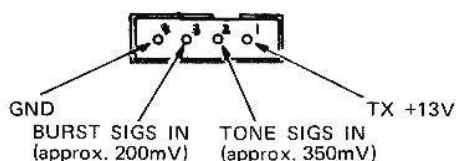

TONE IN CONNECTOR

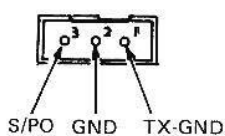

ACC CONNECTOR

## UNDERSIDE CABINET SWITCHES

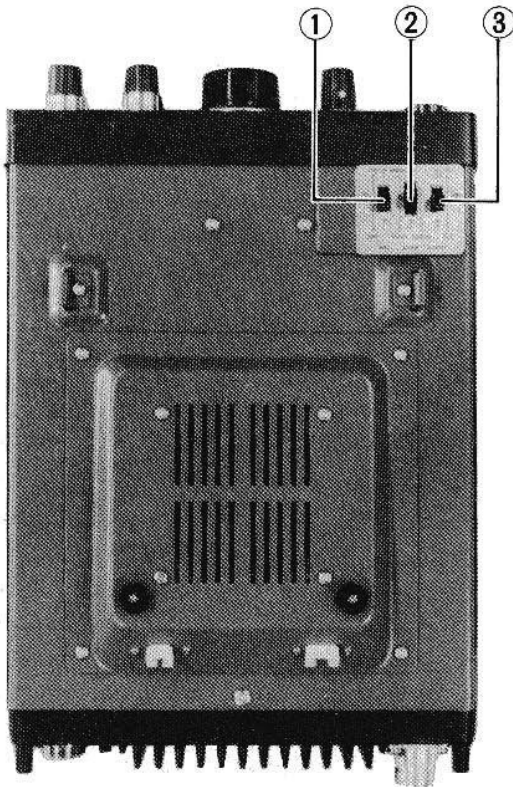

### (1) SAT (Satellite)

This switch allows the operating frequency to be changed while transmitting. This feature is useful especially for satellite operation, for it allows the operator to zero on the proper frequency within the satellite passband. Neither VFO A/B TXA nor the CLARIFIER function works when the SAT switch is placed in the ON position.

### (2) SCAN

This switch will select scanning stop on a busy or clear channel in the FM mode. Manual scanning stop is also provided on all modes.

### (3) BURST

The BURST switch applies a short "tone burst" to the carrier at the start of each transmission in the "ON" position. This is normally used only for "tone access" repeater actuation.

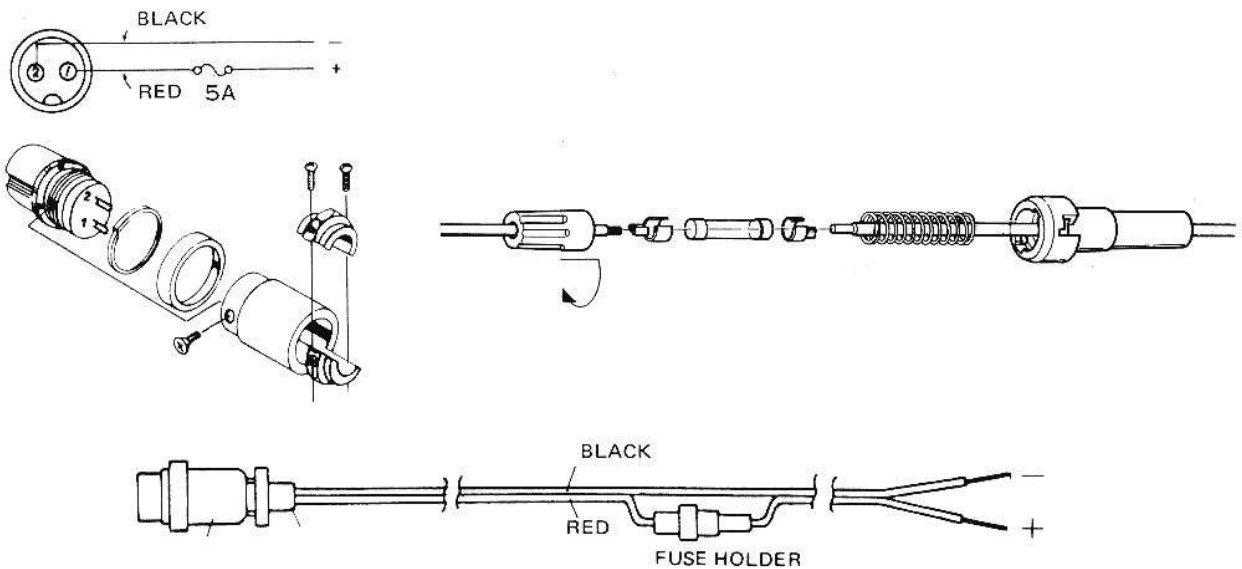

POWER CORD CONNECTIONS

# INSTALLATION

## ANTENNA CONSIDERATIONS

The FT-780R is designed for operation using an antenna presenting a 50 ohm resistive load. The automatic final transistor protection circuitry will reduce the power output to protect the transistors when a high antenna SWR is encountered. The SWR on the antenna should, if possible, be kept below 1.5 : 1 at all times to secure full output from the transceiver.

In most cases, coverage is a function of antenna height. The antenna for base station operation should be located as high and in the clear as possible. Vertical polarization is standard for FM communications in most areas, so be sure that your antenna is oriented appropriately. Popular antennas for base station use include the 5/8 wavelength vertical or one of the many stacked dipole arrays. For accessing repeaters a long distance away, a Yagi or other high gain directional array may be required.

For mobile applications, the most popular antennas are the 1/4 wavelength vertical and the 5/8 wavelength vertical, which shows approximately 3 dB gain over the 1/4 wavelength vertical.

Do not economize on coaxial cable, as much power can be wasted in lossy transmission line. For mobile use, the RG-58A/U type of coax may be used. To minimize loss, use the shortest length that is possible. For base stations, use type RG8A/U coaxial cable. For very long runs, type RG17A/U, aluminum-jacketed "foamflex" coax, or air dielectric "heliac" cable may be used.

## MOBILE INSTALLATION

For mobile service, the FT-780R should be installed where the digital display, controls, and microphone are easily accessible for operation. The transceiver may be installed in any position without loss of performance. A suitable location would be stop the transmission tunnel. A universal bracket is supplied with your transceiver for mobile installation. Refer to Fig. 1 for mounting details.

1. Use the universal mounting bracket as a template for positioning the mounting holes. Use a 3/16" diameter bit for drilling these holes, allowing clearance for the transceiver, its cables and microphone, and its controls. Secure the mounting bracket with the screws, washers, and nuts supplied, as shown in the drawing.
2. Ease the transceiver into the guide rail, and slide it into the desired position. Tighten the knobs on the outside of the universal bracket to secure the transceiver.
3. The microphone hanger may be installed wherever convenient for access to the microphone.

Power connections should be made directly to the automobile battery. Routing through the cigarette lighter may cause the lighter fuse to blow if the fuse is not of sufficient rating. As well, connection directly to the battery allows the memory circuits to remain activated when the ignition is turned off, using the BACKUP switch.

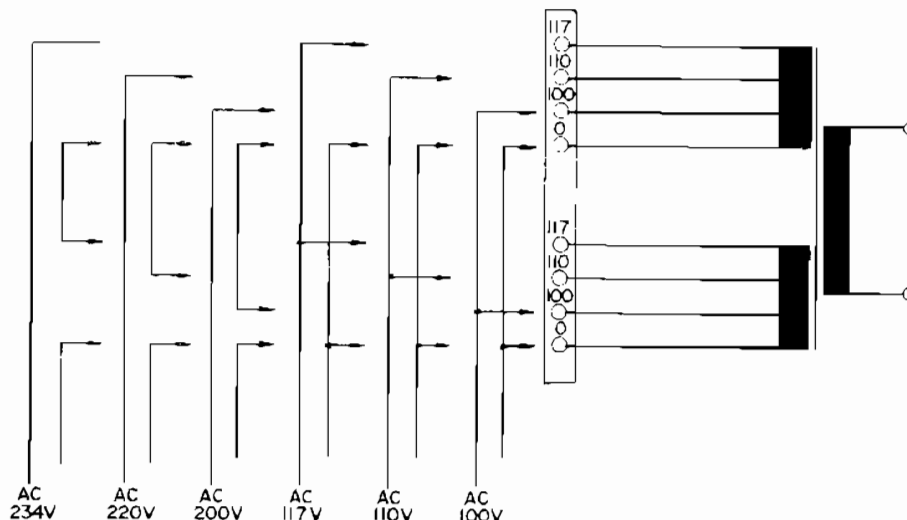

FP-80A POWER TRANSFORMER PRIMARY CONNECTIONS

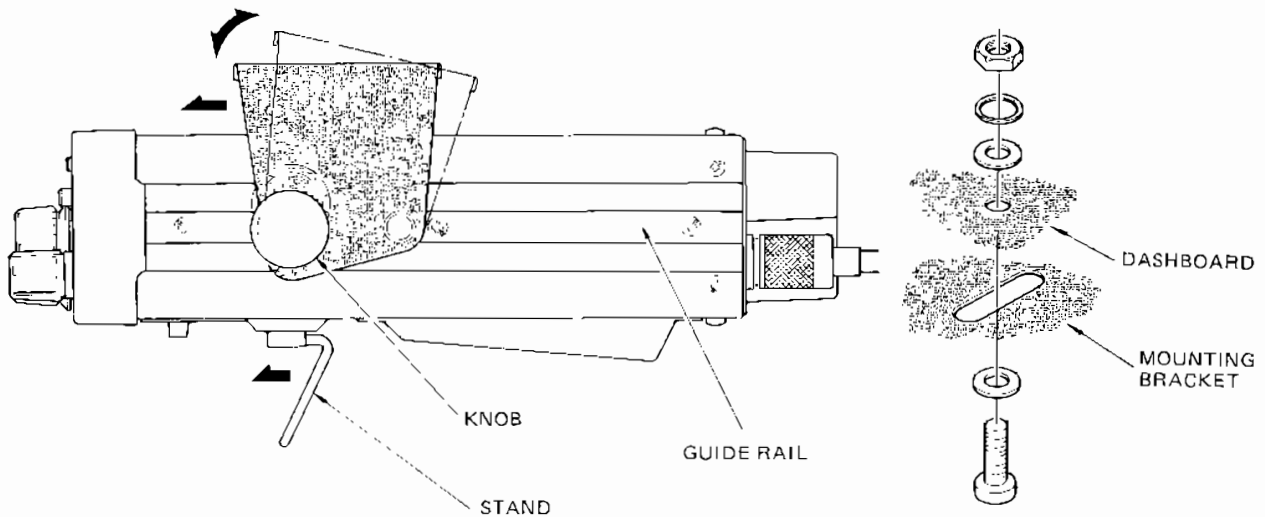

Figure 1

Connect the RED lead of the power cord to the POSITIVE (+) battery terminal, and connect the BLACK lead to the NEGATIVE (-) terminal. If it is necessary to extend the power cable, use #16 AWG insulated copper wire, and use the minimum length practicable to reduce voltage drop.

Connect the power cable to the POWER receptacle on the rear apron, connect the coaxial cable from the antenna to the rear apron ANT receptacle, and connect the microphone to the jack appropriate for the microphone in use. An external speaker may be connected to the rear apron SP jack, if desired. Use the speaker plug supplied with the transceiver. Insertion of a plug into this jack automatically cuts off the internal speaker.

**WARNING**

NEVER APPLY AC POWER TO THE REAR PANEL POWER JACK OF THE TRANSCEIVER. NEVER CONNECT A DC POWER SOURCE OF GREATER THAN 15 VOLTS TO THE REAR PANEL POWER JACK. ALWAYS REPLACE FUSES WITH A FUSE OF THE PROPER RATING. FAILURE TO OBSERVE THESE SIMPLE PRECAUTIONS WILL VOID ALL WARRANTIES ON THIS EQUIPMENT.

**BASE STATION INSTALLATION**

A base station mounting stand is supplied with your transceiver, to provide easier viewing of the display and controls. A power supply capable of supplying 5 amps at 13.8 VDC is required for operation from AC mains. The FP-80A AC power supply option provides the required 13.8 VDC for the FT-780R transceiver. See your Yaesu dealer.

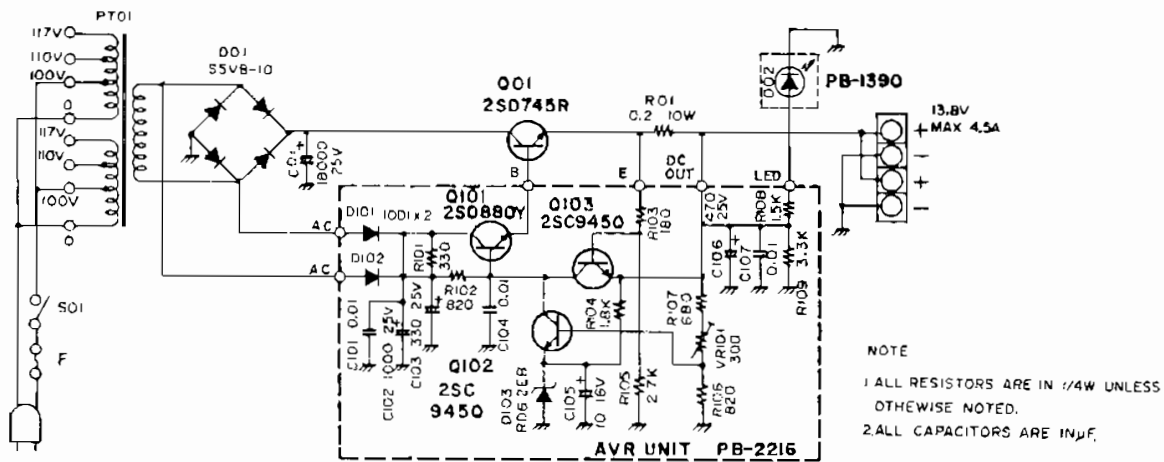

FP-80A POWER SUPPLY

# OPERATION

The all solid-state design of the FT-780R means that tuning procedures are very simple. The following paragraphs will describe the tuning procedures for receiver and transmitter operation.

## INITIAL CHECK

Before connecting the transceiver to the power supply, be certain that a fuse of the proper rating is in use, and that a 50 ohm antenna has been connected to the antenna jack.

## FREQUENCY SELECTION USING MAIN DIAL

When the transceiver is initially turned on, the digital display will read the preset frequency \*445.000.0 MHz, and frequency control will be via the main tuning dial. After memory, scanning, or priority operation, pressing the DIL button will return control to the main dial. Rotate the dial to secure the operating frequency desired. Since tuning steps depend on the combination of the MODE switch and STEP switch as shown in Table 1, use the synthesizer step for easy tuning. When the upper or lower bandedge is reached the next synthesizer step will automatically be to the opposite bandedge. Thus, after \*449.999.9 MHz, the next step is 440.000.0 MHz. While transmitting, the operation frequency can not be changed in any operation modes except the satellite mode.

\* A model.

## RECEIVER OPERATION

Preset the controls and switches as follows:

MODE . . . . . Desired mode  
SQL . . . . . Fully counterclockwise  
STEP . . . . . Desired synthesizer step  
VFO A/B TXA . . . . VFO "A" position  
SCAN . . . . . MAN position  
All other switches should be turned off initially.

Rotate the VOL control clockwise to turn the transceiver on and adjust for a comfortable level.

### (1) SSB mode

Using the main tuning dial, tune in an SSB signal. The STEP switch should be set to M or F position so that you can secure the operating frequency

desired in 100 Hz or 1 kHz steps. When you get close to the desired frequency, set the STEP switch to S position for 10 Hz step in order to tune in the signal smoothly. When pulse type noise such as ignition noise is encountered, press the NB (noise blanker) switch.

### (2) CW mode

With the clarifier off, tune in a CW signal. When the incoming signal is tuned to a beat note of 800 Hz, your transmit frequency will coincide with that of the other station. If another beat note is desired, or if the other station drift, then use the clarifier function.

### (3) FM mode

Using the main tuning control, tune in an FM signal for a maximum and steady S-meter reading and a clear, natural voice output from the speaker.

Set the STEP switch to the M (25 kHz) position, as almost all FM stations use 25 kHz steps. When you change the operating mode from SSB/CW to FM, all the digits of the operating frequency below 10 kHz will be set to zero by pressing the F.SET button.

When the channel is clear, rotate the SQL control to the point where the background noise is just silenced. Do not rotate the SQL control much beyond this threshold point, or else the receiver will not respond to weak signals. The BUSY/MOD lamp will light up when the squelch circuit is opened. If the S-meter wobbles, or if it is impossible to obtain clear audio, it is possible that the incoming signal is on another mode such as SSB.

## TRANSMITTER

Before transmission, be certain that the frequency on which you are going to operate is clear to prevent interruption of the other station's operation. It is important that an antenna or dummy load be connected to the antenna jack at all times.

### (1) SSB mode

Set the MODE switch to SSB and close the microphone PTT switch; the ON AIR lamp should light up. Speak into microphone in a normal voice; the S'PO LEDs will light up according to the relative output power.

## (2) CW mode

Plug a key into the KEY jack on the rear panel. In the key-down condition, the 8–9 LEDs of the indicator will light up. Since the semi-break-in circuit is furnished, when the key is closed, your keying activates the transmitter, and the 800 Hz side tone will be heard from the speaker. With the HI/LOW switch pressed, the power output of 10 watts may be reduced to 1 watt, and the LOW lamp will light up.

## (3) FM mode

Set the MODE switch to FM, and close the microphone PTT switch. When transmitting, 8–9 LEDs which show relative output power will light up, and BUSY/MOD lamp will be illuminated according to the voice input. On this mode, 10 watts of RF output power can also be reduced to 1 watt by pressing the HI/LOW button.

## MEMORY OPERATION

A total of four memory channels are available for operation. Storage and recall of memory channels allows considerable operating flexibility. The storage and recall procedure is extremely simple.

- (1) Rotate the main tuning dial to the desired frequency, for example 446.640.0 MHz. Now rotate the MEMORY switch to position 1. Press the M button to store 446.640.0 MHz into memory channel position 1.
- (2) Now rotate the main tuning dial to another frequency (for example 446.360.0 MHz). For instant return to 446.640.0 MHz, press MR button, the 446.640.0 will be displayed on the digital readout.
- (3) To return again to 446.360.0 MHz, press DIL, and you will be operating on 446.360.0 MHz.
- (4) Memory channels 2, 3 and 4 may be programmed and recalled as above.
- (5) When you push the MR button, the far right LED on the readout will illuminate, indicating the memory channel.
- (6) To return frequency control to the main tuning dial, push the DIL button.
- (7) Set the STEP switch to the desired step before activating the clarifier in the memory operation. Changing the synthesizer step with the CLAR switch ON will lock the operating frequency.

## SCANNER OPERATION

Fingertip switches, located on the microphone, allow convenient frequency control while driving. The simple operating procedure is described below.

- (1) Set the bottom panel SCAN switch to the MAN position. Push the DIL switch to select operation on the dial frequency.
- (2) Press the microphone UP switch for an instant to shift the frequency up by one step. If you hold the UP button for more than 1/2 second, the scanner will be activated. To stop the scan, press the PTT switch or one of the scanning controls on the microphone. If you push the PTT switch, no transmission will occur; release the PTT switch, then press it again for normal transmission.
- (3) To scan lower in frequency, use the same procedure, but press the DWN button.
- (4) In the FM mode, to halt the scan automatically on a busy channel, set the bottom panel SCAN switch to BUSY. In this mode, when the scanner encounters a signal strong enough to open the receiver squelch, scanning will stop. When the bottom panel switch is placed in the CLEAR position, the scan will stop when a clear channel (one where the squelch will not open) is found.
- (5) To scan only the memory channels, rotate the MEMORY switch to the MS (memory scan) position. Now press the UP or DWN switch on the microphone. The scanning rate for memory scan will be approximately two channels per second. The scan may be halted in any of the ways discussed previously. The BUSY and CLEAR positions of the SCAN switch are particularly helpful when scanning the memory channels in the FM mode.

## PRIORITY CHANNEL OPERATION

A priority channel may be used in conjunction with a memory channel for increased flexibility. Here is how to set up the FT-780R for priority operation.

- (1) First program one or more memory channels for priority use. For example, store 446.640.0 MHz into memory channel 1. Set the bottom panel SCAN switch to MAN. Rotate the main dial to the desired frequency (for example 446.360.0 MHz).
- (2) Now set the MEMORY switch to 1 and push MR to recall 446.640.0 MHz; now push the PRI (priority) switch. The display will indicate 446.360.0 P, and every 7 seconds the display will switch to 446.640.0 MHz allowing you to check it for activity.
- (3) If you have other frequencies stored in memory, you may rotate the MEMORY switch to select one for use with the priority channel.
- (4) In the FM mode, you may use the SCAN switch to good advantage during priority operation, as described in SCANNER OPERATION.
- (5) If you wish to return to normal operation from the priority mode, push the DIL button. Now control is shifted back to the main dial.

## REPEATER OPERATION

- (1) Repeater shifts of +5 MHz (+7.6 MHz), and - 5 MHz (- 7.6 MHz) are built into the FT-780R. To select these shifts, set the bottom panel RPT switch to the + or - position respectively.
- (2) To cover unusual repeater splits, you can use the VFO A/B TXA feature.  
Example: receive frequency 448.640 MHz with 1 MHz split. Rotate the main tuning dial to the 447.640 MHz and press the VFO A/B TXA button on the front panel; now the transmit frequency, 447.640 MHz, is memorized. Rotate the main tuning dial to 448.640 MHz for receiving. If you close the PTT switch, your transmit frequency will be shifted to 447.640 MHz.

- (3) A 1750 or 1800 Hz tone generator is included with your transceiver for accessing repeater requiring such a tone. When the T.CALL switch is pushed, a tone will be superimposed on your transmitted signal. This switch also activates the PTT function, and transmits the access tone, for as long as the switch is held. An external tone or burst generator, optional FTS-64E may be connected through the rear panel TONE IN CONNECTOR.

## INITIALIZING FREQUENCY/BACKUP FEATURE

The FT-780R includes a backup feature which will hold all memory frequencies, as well as dial frequency, when the front panel power switch is turned off. So long as the DC power to the rear apron power jack is not interrupted, these frequency will be held. When the power is again turned on, the frequency and mode (memory priority, dial, etc.) last used will be recalled, but scanning mode is automatically reset to dial mode. However, if the power cord is connected to 13.8 VDC circuit that is switched off along with the automobile ignition, all memory channels as well as the dial frequency will be reset to the preset frequency.

## SATELLITE OPERATION

The FT-780R includes provision for changing the transmitting frequency while you are transmitting (some other synthesized transceivers lock up during transmission). The ability to change frequency in this manner is important during satellite operation, as Doppler shift may cause your downlink frequency to be  $\pm 3$ –4 kHz from a predicted value. While listening on the downlink, and sending a series of dots, satellite operators can usually find themselves quite quickly.

To allow frequency change during transmission, set the bottom panel SAT (Satellite) switch to ON. For most satellite work on SSB or CW, the synthesizer step switch should be set to Slow or Medium. You may now close the PTT switch and vary your frequency as desired. Note that your receiver frequency will also change if you rotate the main dial.

When the SAT switch is set to ON, the  $\pm$  repeater shift and receive clarifier features are disabled.

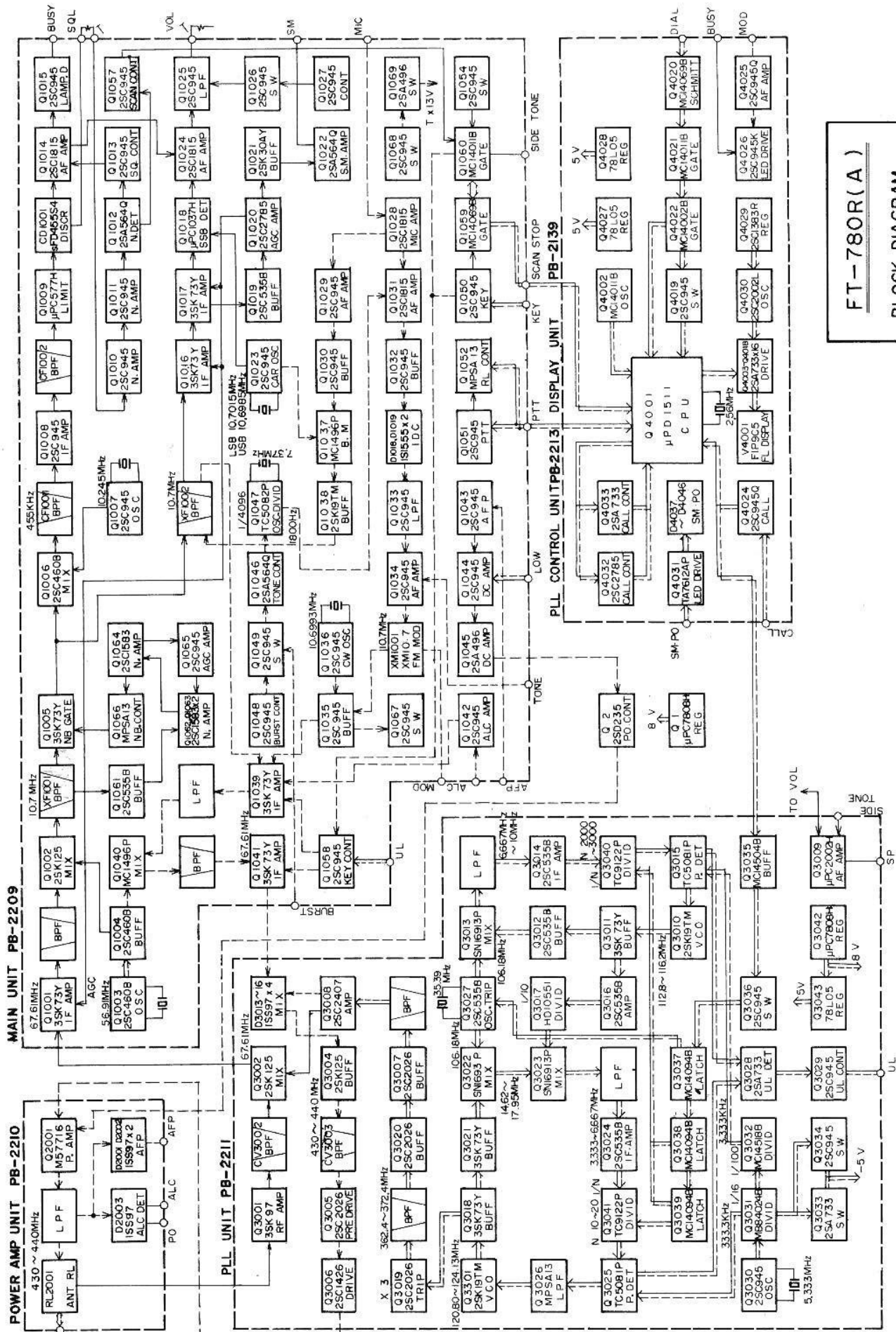

FT-780R(A)  
BLOCK DIAGRAM

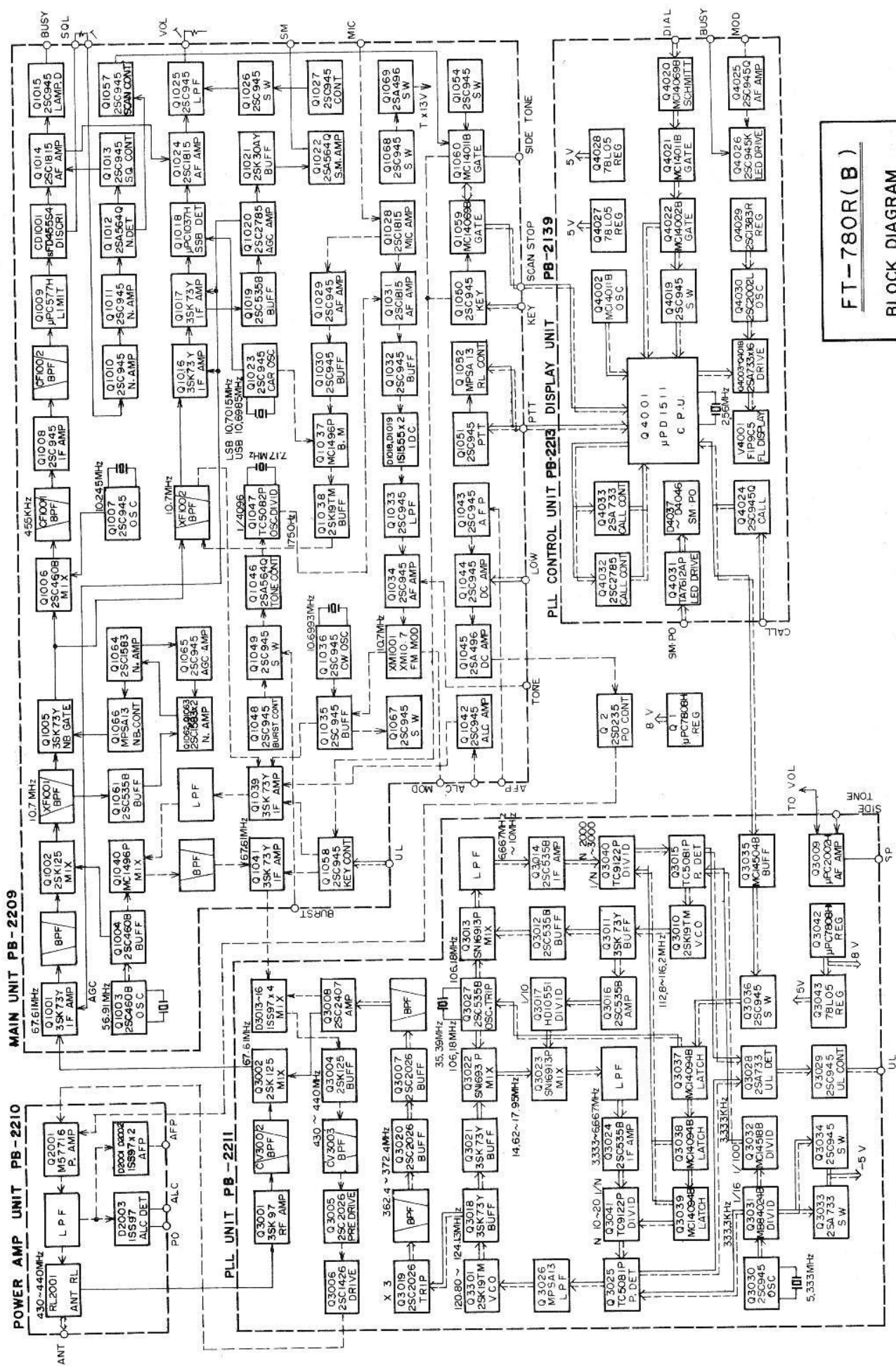

FT-780R(B)  
BLOCK DIAGRAM

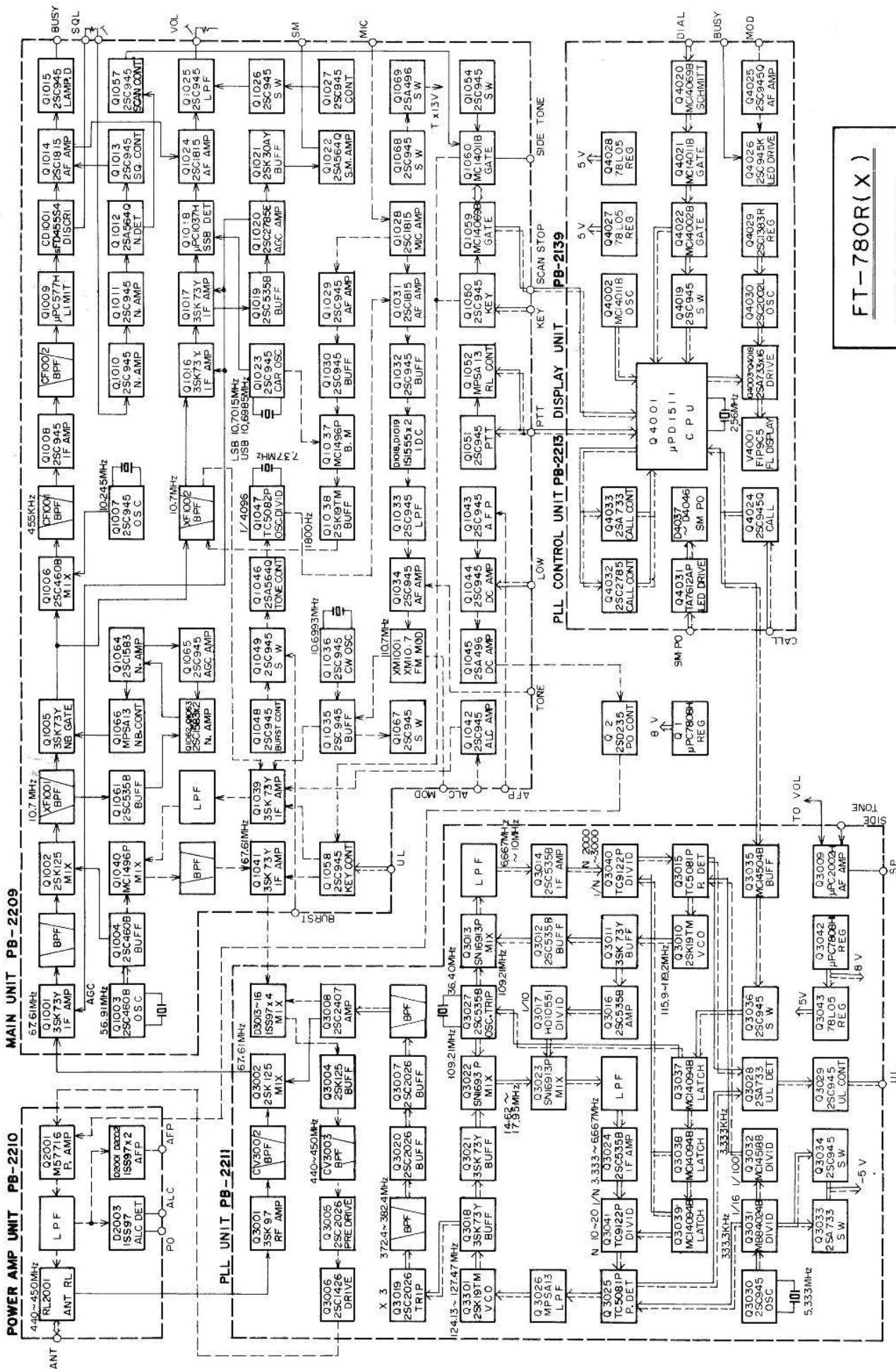

FT-780R(X)  
BLOCK DIAGRAM

## CIRCUIT DESCRIPTION

The block diagram, and circuit description to follow will provide you with a better understanding of this transceiver. Please refer to the block and schematic diagrams for specific circuit details.

### RECEIVER

The RF signal from the antenna jack is applied to the PLL UNIT through a low pass filter and the antenna relay, RL<sub>2001</sub>. The signal is amplified by Q<sub>3001</sub> (3SK97), a dual gate GaAs FET with excellent rejection of cross modulation and intermodulation. The amplified signal is fed to the 1st mixer, Q<sub>3002</sub> (2SK125), where the RF signal is mixed with a local signal delivered from Q<sub>3008</sub> (2SC2407), resulting in a 67.61 MHz first IF signal.

The first IF signal is amplified by Q<sub>1001</sub> (3SK73Y) and then passed through a stagger tuned bandpass filter to the second mixer Q<sub>1002</sub> (2SK125). The signal is then mixed with a second local signal of 56.91 MHz, which is delivered from buffer Q<sub>1004</sub> (2SC460), thus producing a second IF signal (10.7 MHz).

The 2nd IF signal is passed through a monolithic crystal filter, XF<sub>1001</sub> (10M30B), which has ±15 kHz bandwidth, and amplified by Q<sub>1005</sub> (3SK73Y), which acts as a switch driven by the NB (noise blanker) circuit. The amplified signal from Q<sub>1005</sub> is fed to IF amplifiers for each mode.

FM mode signals are fed to 3rd mixer Q<sub>1006</sub> (2SC460), where the signal is mixed with a 10.245 MHz local signal, resulting in a 455 kHz 3rd IF signal.

The 3rd IF signal is passed through a ceramic filter, CF<sub>1001</sub>, which has a ±4.5 kHz bandwidth, and then fed to the FM mode IF amplifier.

The filtered signal is amplified by Q<sub>1008</sub> (2SC945Q) and passed through CF<sub>1002</sub>, which has a ±7.5 kHz bandwidth. The filtered FM signal is amplified by Q<sub>1009</sub> (μPC577H) and demodulated by CD<sub>1001</sub> and D<sub>1002</sub>, D<sub>1003</sub> (1S188FM). The demodulated FM signal is amplified by Q<sub>1014</sub> (2SC1815GR) and then fed to the AF amplifier.

SSB and CW mode signals from the Q<sub>1005</sub> are passed through a crystal filter, XF<sub>1002</sub>, which has a

very high shape factor, to improve adjacent frequency selectivity. The filtered SSB signal is amplified by Q<sub>1016</sub> and Q<sub>1017</sub> (3SK73Y), and then fed to the balanced demodulator, Q<sub>1018</sub> (μPC1037H), where a carrier signal is applied from the carrier oscillator Q<sub>1023</sub> (2SC945P); the detected audio output is then fed to the AF amplifier.

The audio signals from each demodulator are passed to the active lowpass filter, which consists of Q<sub>1024</sub> and Q<sub>1025</sub> (2SC945Q) to eliminate the unwanted noise portion of the signal. The audio signal is then fed, through the AF gain control, to the audio output amplifier, Q<sub>3009</sub> (μPC2002H), providing about 2 watts of audio output to the speaker.

### S-METER CIRCUIT

A portion of the amplified IF signal is fed to Q<sub>1019</sub> (2SC535B), a buffer amplifier, through C<sub>1080</sub>. The amplified signal is then applied to the AGC detector, D<sub>1009</sub>/D<sub>1010</sub> (1S188FM). The rectified signal is amplified by DC amplifier Q<sub>1020</sub> (2SC-2785E) for AGC control. This AGC voltage is delivered to the front panel S.PO indicator to illuminate LEDs according to the input signal strength.

### SQUELCH CIRCUIT

A portion of the demodulated FM signal from the ceramic discriminator (CD<sub>1001</sub>, D<sub>1001</sub>, D<sub>1002</sub>) is fed to noise amplifiers Q<sub>1010</sub> and Q<sub>1011</sub> (2SC945P) through VR<sub>1001</sub> and the SQ Control (VR<sub>1B</sub>), and then rectified by Q<sub>1012</sub> (2SA564). The rectified signal is fed to the base of Q<sub>1013</sub> (2SC945P), the squelch control circuit.

When no carrier is present, the rectified DC voltage is applied to the base of Q<sub>1013</sub>, to turn Q<sub>1014</sub> (2SC1815GR) on. With conduction of Q<sub>1012</sub>, the base of Q<sub>1014</sub> is grounded, squelching the audio amplifier.

When a carrier is present, the rectified DC voltage is reduced, the audio amplifier Q<sub>1014</sub> then recovers to normal operation. The BUSY lamp switch, Q<sub>1015</sub> (2SC945P), is also activated by the rectified voltage from the demodulator to illuminate the BUSY lamp when a carrier is present.

## NB (Noise Blanker) CIRCUIT

A portion of the 2nd IF signal from monolithic filter XF<sub>1001...1</sub> is amplified by Q<sub>1061</sub> (2SC535B), Q<sub>1062</sub>, Q<sub>1063</sub>, and Q<sub>1064</sub> (2SC1583). The output signal is rectified by D<sub>1042</sub> and D<sub>1043</sub> (1S188FM), producing a DC voltage. This DC voltage is amplified by Q<sub>1066</sub> (MPSA13) and fed to gate 2 of Q<sub>1005</sub>, the noise blanker gate. A portion of the DC voltage is amplified by Q<sub>1065</sub> (2SC945P), and then fed to Q<sub>1062</sub>, Q<sub>1063</sub> (2SC1583) as a noise blanker AGC voltage. When impulse-type noise is received, the induced DC voltage reduces the gain of Q<sub>1005</sub>, and blocks the signal path momentarily. The noise AGC control voltage is not, however, induced by such impulse-type noise, because the time constant of C<sub>1204</sub>/R<sub>1257</sub> is long. Normal signals, though, induce the noise blanker AGC voltage, reducing the gain of the noise amplifier, allowing normal signal flow at Q<sub>1005</sub>.

## TRANSMITTER

The discussion of the signal flow on transmit will be on a mode by mode basis.

### SSB

The audio input signal from the microphone is amplified by Q<sub>1028</sub> (2SC1815GR) and Q<sub>1029</sub> (2SC945P), the audio level is adjusted to the proper level by VR<sub>1004</sub>, and is applied through an active lowpass filter, Q<sub>1030</sub> (2SC945P), to the double balanced modulator Q<sub>1037</sub> (MC1496P). Here the audio signal modulates the 10.7 MHz carrier signal delivered from the carrier oscillator Q<sub>1023</sub> (2SC945P), resulting in a 10.7 MHz double-sideband signal. The signal is amplified by Q<sub>1038</sub> (2SK19TM-GR) and fed to XF<sub>1002</sub>, a crystal filter, where the unwanted sideband is sliced out. The SSB signal is amplified by Q<sub>1039</sub> (3SK73), and then fed to mixer Q<sub>1040</sub> (MC1496) and mixed with a local signal from the PLL Unit, resulting in a 67.61 MHz SSB signal.

The SSB signal is passed through T<sub>1014</sub>-T<sub>1016</sub>, which minimizing spurious radiation. The signal is then amplified by Q<sub>1041</sub> (3SK73Y), and fed to PLL unit.

The SSB signal applied to mixer D<sub>3013</sub>-D<sub>3016</sub> (1SS97) is mixed with the local signal from the PLL circuit, resulting in a proper operating frequency. Next the signal is buffered by Q<sub>3004</sub> (2SK125), and fed through cavity CV<sub>3003</sub>, which eliminates spurious harmonics, thus providing a clean SSB signal. The signal is then amplified by Q<sub>3005</sub> (2SC2026) and Q<sub>2006</sub> (2SC1426) to the level necessary to drive the power amplifier circuit.

### FM

The output audio signal at Q<sub>1028</sub> is amplified by Q<sub>1031</sub> (2SC1815GR) and Q<sub>1032</sub> (2SC945P) and fed to IDC circuit, consisting of D<sub>1018</sub> and D<sub>1019</sub>, which clips both positive and negative peaks to control the maximum possible deviation; the clipped signal is then passed through an active lowpass filter to eliminate harmonics above the speech range caused by clipping. The output signal is amplified by Q<sub>1034</sub> (2SC945P) to a sufficient audio level and applied to the FM modulation module XM<sub>1001</sub> for modulation, and the maximum deviation is adjusted by VR<sub>1006</sub> prior to delivery to Q<sub>1039</sub>. The signal path is then identical to that of the SSB signal.

### CW

For CW, the 10.8107 MHz carrier signal is generated by Q<sub>1036</sub> (2SC945P), amplified by Q<sub>1035</sub> (2SC945P), and fed to IF amplifier Q<sub>1039</sub>. The signal path is then identical to that of the SSB signal.

The key line is connected to switching transistor Q<sub>1058</sub> (2SC945P) through inverter Q<sub>1060</sub> (MC14011B), which controls the gate voltages at Q<sub>1039</sub> (3SK73) and Q<sub>1041</sub> (3SK59Y), thus turning the RF signal on and off.

An RC circuit connected to the base of Q<sub>1058</sub> produces an ideal keying waveshape for click-free CW operation. The key line is also connected to side tone oscillator Q<sub>1059</sub> (MC14069UB) for

monitoring of the code signal during CW operation. In order to operate on semi-break-in, the Schmitt trigger and delay circuit at Q<sub>1059</sub> activates the RX-TX changeover relay.

### POWER AMPLIFIER CIRCUIT

The RF signal from the Main Unit is amplified by Q<sub>2001</sub> (M57716) in the Power Amplifier Unit, delivering approximately 10 watts of RF output to the antenna through a lowpass filter.

### POWER CONTROL CIRCUIT

When the HI/LOW switch is set to the LOW position, the base of Q<sub>1044</sub> is grounded through VR<sub>1010</sub>, and the collector current of Q<sub>1044</sub> is decreased. Because the output power of Q<sub>2001</sub> is controlled by Q<sub>1044</sub>, the drive level to Q<sub>2001</sub> is decreased, thus reducing the RF output power to approximately 1 watt.

### TONE BURST CIRCUIT

When the T.CALL switch is pressed, the base of Q<sub>1046</sub> (2SA564A) is grounded, and DC voltage is applied to tone burst oscillator Q<sub>1047</sub> (TC5082P) to generate a 1750 Hz or 1800 Hz tone signal. The tone is superimposed on the transmit signal as long as the switch is held.

### ALC (Automatic Level Control) CIRCUIT

A portion of the output power from Q<sub>2001</sub> is applied through strip line to rectifier D<sub>2003</sub> (1SS97) producing a DC voltage. The DC voltage is amplified by DC amplifier Q<sub>1042</sub> (2SC1815Y) and fed to gate 2 of Q<sub>1039</sub> to control its gain, thus preventing overdrive. The ALC level is adjusted by VR<sub>1008</sub> for proper drive to Q<sub>2001</sub>.

### AFP (Automatic Final Protection) CIRCUIT

If the transmitter is activated without an antenna being connected, or if a high VSWR is present at the antenna jack, the reflected power is coupled through a stripline to detector, D<sub>2002</sub> (1SS97).

The detected AFP voltage is applied through VR<sub>2002</sub> to Q<sub>1043</sub> (2SC945P) in the Main Unit. As the reflected power increases, the AFP voltage also increases, and consequently Q<sub>1043</sub> conducts. The voltage at gate 2 of Q<sub>1039</sub> (3SK73Y) then decreases, resulting in lower output power. When the transceiver is correctly matched to an antenna, full power output will be obtained.

### PLL CIRCUIT

The PLL circuit is comprised of three PLL oscillators each consisting of a reference crystal oscillator, a programmable divider, a prescaler, and a phase comparator. The PLL produces local signals for the receiver and transmitter stages, using a synthesis scheme which produces 10 Hz steps.

### PLL Circuit Configuration

Voltage Controlled Oscillator VCO-1, consisting of Q<sub>3301</sub> (2SK19TM), D<sub>3002</sub>/D<sub>3003</sub> (1T25), and associated circuitry, generates a signal at 128.80 – 124.13 MHz. This signal is multiplied by a factor of three at Q<sub>3019</sub> (2SC2026), then fed through a bandpass filter to eliminate spurious responses. The filtered signal is then amplified by Q<sub>3020</sub> and Q<sub>3007</sub> (2SC2060), passed through another bandpass filter, then amplified further by Q<sub>3008</sub> (2SC2047) prior to delivery to the receiver first mixer, Q<sub>3002</sub> (2SK125) or the transmit mixer, D<sub>3013</sub> – D<sub>3016</sub> (1SS97).

A portion of the signal from buffer Q<sub>3008</sub> is amplified by Q<sub>3007</sub> (2SC2026) and applied to mixer Q<sub>3022</sub> (SN16913), where the VCO signal is mixed with a local signal at 106.18 MHz delivered from Q<sub>3027</sub> (2SC3027). The resulting signal at 14.62–17.95 MHz is, in turn, delivered to another mixer, Q<sub>3023</sub> (SN16913), where the 14.62–17.95 MHz signal is mixed with a local signal at 11.28–11.68 MHz from PLL Loop 2. The resulting PLL IF signal at 3.333–6.667 MHz is fed through a low-pass filter, consisting of L<sub>3048</sub>, L<sub>3049</sub>, C<sub>3131</sub>, C<sub>3132</sub>, and C<sub>3133</sub>, then amplified by Q<sub>3024</sub> (2SC535B). The output from Q<sub>3024</sub> is then fed to a programmable divider, Q<sub>3041</sub> (TC9122P), where the PLL IF signal is divided according to the ratio programmed by the Central Processing Unit (CPU).

VCO-2 consists of Q<sub>3012</sub> (2SK19TM), D<sub>3002</sub>/D<sub>3003</sub> (1T25), providing a signal at 112.8–116.2 MHz. The VCO signal is buffered through Q<sub>3011</sub> (3SK73Y) and Q<sub>3012</sub> (2SC535B), while a portion of the output from Q<sub>3011</sub> is amplified by Q<sub>3016</sub> (2SC535B) in order to drive the 1/10 divider, Q<sub>3017</sub> (HD10551), where the 112 MHz signal is divided by 10 and delivered to mixer Q<sub>3023</sub> in PLL Loop 1.

The buffered output from Q<sub>3012</sub> is fed to the PLL Loop 2 local mixer, Q<sub>3013</sub> (SN16913), where the 112 MHz signal is mixed with a local signal at 106.18 MHz, generated by Q<sub>3027</sub>. The output from the mixer, at 6.667 10.000 MHz, is passed through a low-pass filter to IF amplifier Q<sub>3014</sub> (2SC535B).

The amplified signal is then applied to a programmable divider, Q<sub>3040</sub> (TC9122P), which divides the frequency by a factor of 2000–3000, resulting in a 3.333 kHz signal. This signal is applied to a phase detector, Q<sub>3015</sub> (TC5081P), where it is compared with a reference 3.333 kHz signal delivered from Q<sub>3032</sub> (MC14518). Any phase difference is converted into an error-correcting voltage, which is used to control varactor diodes in the PLL, locking the PLL on the proper frequency.

PLL local oscillator/tripler Q<sub>3027</sub> (2SC535B) oscillates either in 3 Hz steps (for control of PLL Loop 1) or 0.3 Hz (to control PLL Loop 2). The resultant synthesis provides local oscillator steps of 10 Hz.

The CPU command signals, which control the dividing ratio of Q<sub>3041</sub>, are converted into series by Q<sub>3037</sub>–Q<sub>3039</sub> (MC14094). The control signal is also delivered to programmable divider Q<sub>3040</sub> in PLL Loop 2 and to the VCXO oscillator/tripler, Q<sub>3027</sub>.

When any VCO is unlocked, an error voltage from the phase detector is fed to the unlock control circuit, consisting of Q<sub>3028</sub> (2SA733) and Q<sub>3029</sub> (2SC955). The amplified DC voltage is applied to a key control circuit so as to disable transmit capability under conditions of PLL unlock.

## PLL Control Circuit

In the PLL Control Unit, a 4 bit parallel processing CPU is used to control the operating frequency, UP/DOWN scanning, priority channel, or memory channel selections. The CPU has one input port, three I/O ports and four output ports. The CPU processes input data by means of the main dial or other control switches in accordance with the program stored in an ROM for control of the PLL frequency, indication of the operating frequency, or memory channels on digital display. The CPU is also furnished with a function to halt transmission when any VCO is unlocked, resulting in a fail-safe system.

## MAINTENANCE AND ALIGNMENT

This equipment has been carefully aligned and tested at the factory prior to shipment. If the instrument is not abused, it should not require other than the usual attention given to electronic equipment.

Service or replacement of a major component may require considerable realignment. Under no circumstances, though, should realignment be attempted unless the operation of the transceiver is fully understood, the malfunction has been carefully analyzed, and the fault has definitely been traced to misalignment rather than part failure. Service work must only be performed by experienced personnel using the proper test equipment.

Never align this transceiver without having a 50 ohm dummy load connected to the antenna jack, unless otherwise noted. Troubleshooting using an antenna can result in misleading indications on test equipment.

### EQUIPMENT REQUIRED

- (1) RF Signal Generator: Hewlett-Packard Model 8640B or equivalent, with one volt output at 50 ohms, and frequency coverage to 500 MHz.
- (2) Vacuum Tube Voltmeter (VTVM): Hewlett-Packard Model 410B or equivalent, with an RF probe good to 500 MHz.
- (3) Dummy Load/Wattmeter: bird Model 43 + UHF Dummy Load.
- (4) AF Signal Generator: Hewlett-Packard Model 200AB or equivalent.
- (5) IF Sweep Generator: capable of output at 10.81 MHz.
- (6) RF Sweep Generator: capable of output at 420–460 MHz.
- (7) Oscilloscope: Hewlett-Packard Model 1740A or equivalent.
- (8) FM Deviation Meter
- (9) Precision Frequency Counter: Yaesu Model YC-500 or equivalent, with resolution to 0.01 kHz and frequency coverage to 500 MHz.

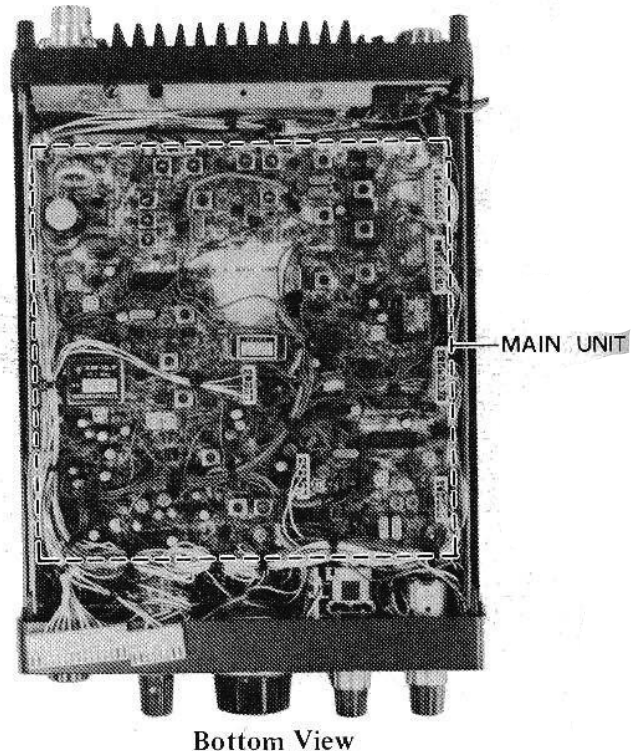
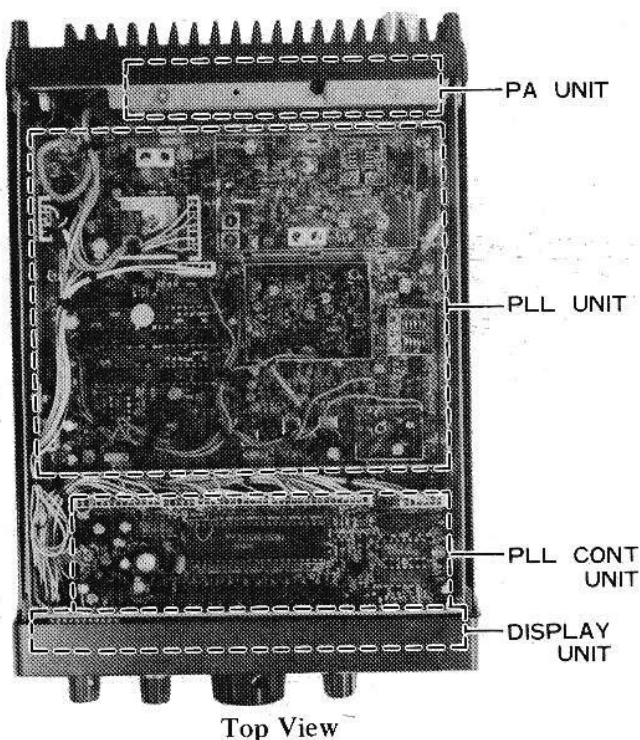

### UNIT LOCATIONS

## PERFORMANCE CHECKS

Make all performance checks at 13.8 VDC under load.

Check the transmitter power output as follows:

- (a) Connect a suitable dummy load/wattmeter to the antenna jack.
- (b) Set the MODE switch to the FM SIMP position, and key the transceiver while observing the power output, which should be approximately 10 watts. At full power output, 8–9 LED's will light up on the S.PO indicator.

- (c) Set the MODE switch to SSB, and key the transmitter. Speak in a normal voice into the microphone; 8–9 LED's should light up.

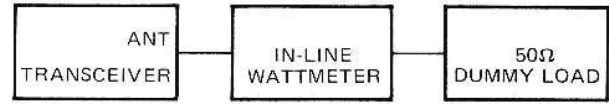

PO TEST SETUP

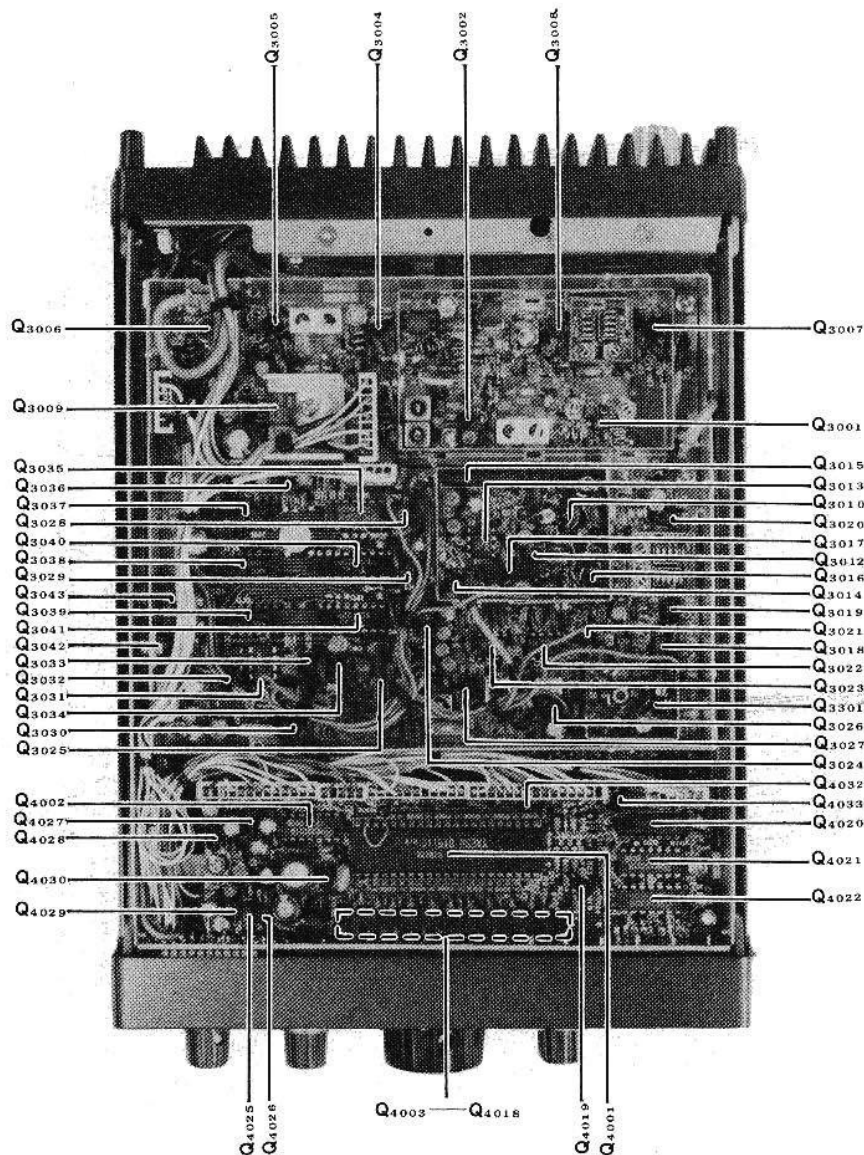

PART LOCATIONS (Top View)

Check the receiver sensitivity as follows:

- (a) Connect an AC VTVM to the SP jack. Set the MODE switch to the FM position and rotate the SQUELCH control fully counterclockwise.
- (b) Connect the RF output of a precision UHF signal generator to the antenna jack and note the VTVM reading with no signal input. Adjust the AF GAIN control and the VTVM range, as required, to obtain a full scale VTVM reading. DO NOT change the setting of the AF GAIN control after this calibration has been made.

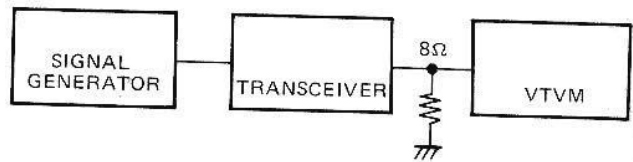

RX SENSITIVITY TEST SETUP

- (c) Set the signal generator to the receiver frequency of the transceiver, and adjust the output amplitude of the signal generator until the VTVM reads 20 dB (1/10 voltage) below the reading in step (b). The signal generator output voltage at this point is the 20 dB quieting sensitivity, and it should be approximately 0.35  $\mu$ V.

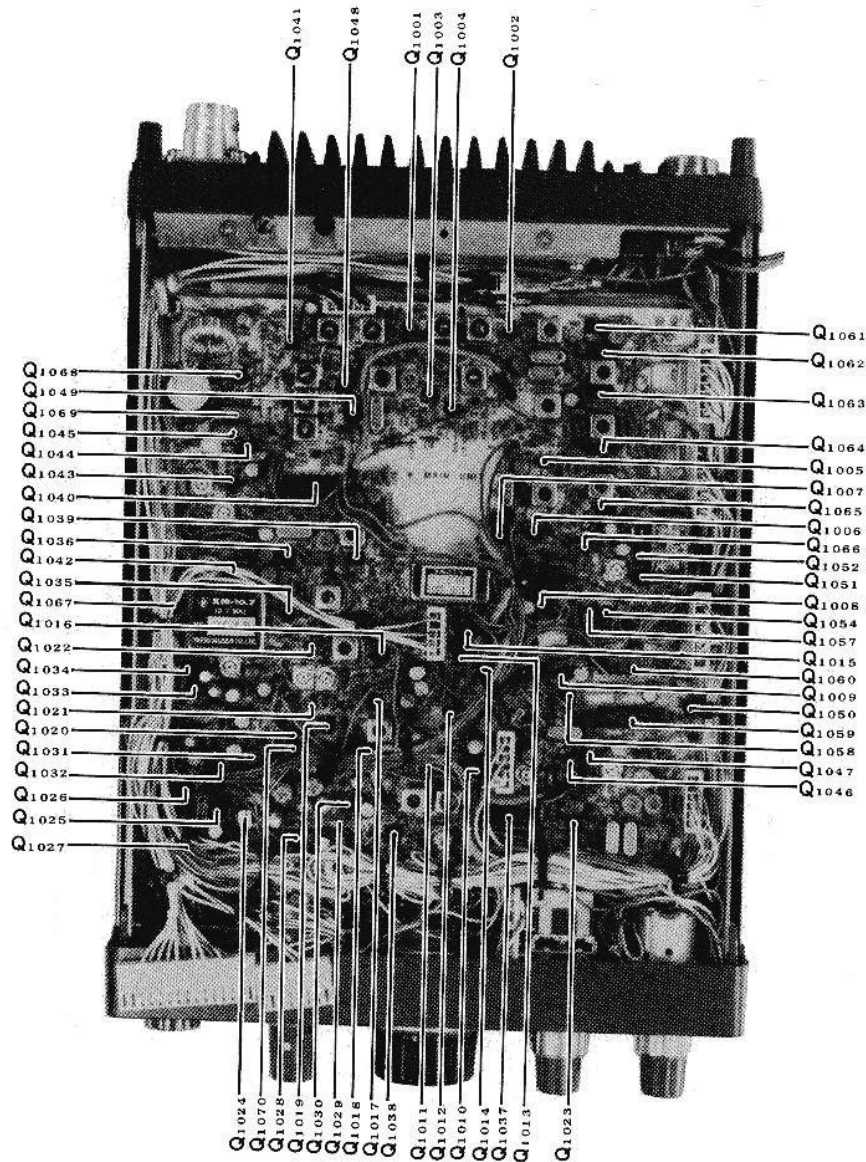

PART LOCATIONS (Bottom View)

- (d) Set the MODE switch to SSB and connect the AC VTVM to the speaker output. Apply an unmodulated 0.5  $\mu$ V signal from the signal generator, and tune the transceiver main dial for a maximum VTVM reading.
- (e) Adjust the AF GAIN control for a reading of 450 mV on the VTVM.
- (f) Reduce the signal generator output and read the VTVM: the VTVM reading should be 45 mV for a 20 dB S/N ratio.

If the above check indicates a need for realignment, it is recommended that the unit be returned to the dealer for servicing. The sophisticated CPU and control circuitry, in particular, are so critical that they should not be touched by other than an experienced technician. Attempts to realign the transceiver tuned circuits without the proper equipment may result in degraded transceiver performance.

## RECEIVER SECTION

### 1) 2nd Local Oscillator

- a) Set the MODE switch to FM SIMP, and connect the RF probe of a VTVM to the collector of Q<sub>1004</sub>.
- b) Adjust TC<sub>1001</sub> to the point where the deflection on the VTVM shows 10% less than the peak. Be certain the oscillator is working in a stable manner.
- c) Connect a frequency counter to the gate of Q<sub>1002</sub> and rotate the core of L<sub>1001</sub> for a reading of exactly 56.91 MHz.
- d) Connect the probe of a VTVM to the gate of Q<sub>1002</sub> and adjust the core of T<sub>1004</sub> for maximum deflection on the VTVM (400–500mV RMS).

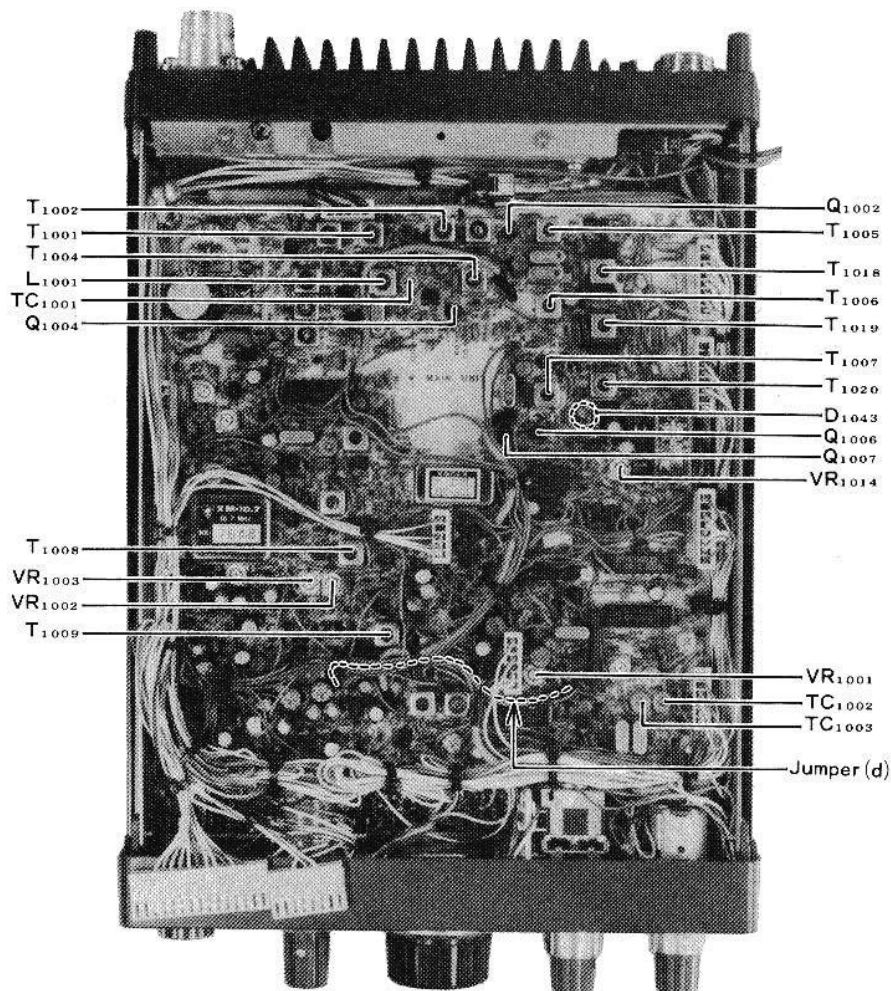

ALIGNMENT AND TEST POINTS FOR RECEIVER

## 2) 2nd IF Amplifier

- Set the MODE switch to FM SIMP, and adjust VR<sub>1001</sub> to the fully counterclockwise position.
- Connect a sweep generator to the gate of Q<sub>1002</sub> and connect an oscilloscope, through a detector, to the base of Q<sub>1006</sub>.
- Set the frequency of the sweep generator to 10.7 MHz, and apply output from the generator.
- Adjust T<sub>1005</sub>, T<sub>1006</sub> and T<sub>1007</sub> until the scope pattern illustrated in Figure 2 is obtained.

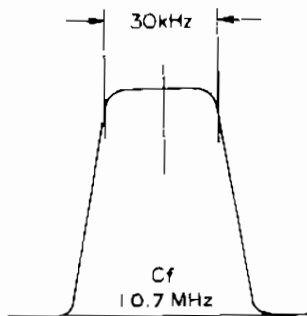

Figure 2

## 3) 3rd Local Oscillator

- Set the MODE switch to FM SIMP. Connect the probe of a VTVM to the emitter of Q<sub>1007</sub>, and measure the oscillation level. The nominal value is 50mV – 150mV RMS.
- Connect a frequency counter to the emitter of Q<sub>1007</sub>.
- Check the oscillation frequency, which should be 10.245 MHz ± 200 Hz.

## 4) SSB Carrier Oscillator

- Set the MODE switch to LSB.
- Pre-adjust TC<sub>1002</sub> and TC<sub>1003</sub> to their half capacity positions.



- Connect the probe of a VTVM to the inner wire of JUMPER SHIELD (d), referring to the RX alignment point photo for the exact location.
- Measure the output level on both LSB and USB. The nominal value is 150mV – 200mV. (TC<sub>1002</sub> and TC<sub>1003</sub> should be adjusted according to the alignment procedure for the TX section.)

## 5) RF Amplifier

- Connect a UHF sweep generator to the antenna jack, and connect an oscilloscope, through a detector, to the drain of Q<sub>3002</sub>.
- Set the frequency of the generator to 435 MHz (Model X: 445 MHz).
- Adjust TC<sub>3001</sub>, TC<sub>3002</sub> and CV<sub>3002</sub> until the scope pattern illustrated in Figure 3 is obtained.

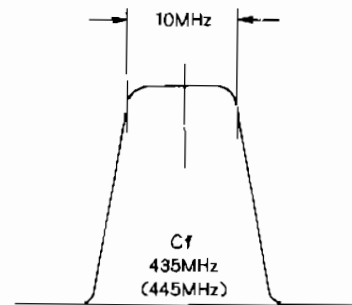

Figure 3

## 6) Total Sensitivity Adjustment

- Set the MODE switch to USB or LSB.
- Connect a standard signal generator to the antenna jack, and set the output level to approximately 10 dB $\mu$  (3.16  $\mu$ V).
- Adjust T<sub>1001</sub>, T<sub>1002</sub>, T<sub>1008</sub> and T<sub>1009</sub> on the MAIN unit, and T<sub>3001</sub>, T<sub>3002</sub> and TC<sub>3003</sub> on the PLL unit for maximum deflection on the S-meter.

## 7) S-meter Full Scale Setting

- Rotate VR<sub>1002</sub> fully clockwise to make sure that all the LED's are illuminated on the S-meter scale.
- Set VR<sub>1002</sub> to the point where all the LED's go off.

- c) Apply a 20 dB $\mu$  (10  $\mu$ V) signal from the signal generator and adjust VR<sub>1003</sub> so that 7 LED's are illuminated.
- d) Reduce the output from the generator to 0 dB $\mu$  (1 $\mu$ V) and adjust VR<sub>1014</sub> to the point where 2 LED's are illuminated.
- e) Repeat Steps c and d a few times to obtain an accurate reading.

#### 8) Noise-Blanker Adjustment

- a) Set the MODE switch to CW, and push the NB switch on.
- b) Connect a signal generator to the antenna jack, and set the output level to 5 dB $\mu$  (1.78  $\mu$ V).
- c) Set the transceiver to receive the signal from the generator.
- d) Connect a DC voltmeter (full scale: 2.5V) to the cathode of D<sub>1061</sub> and ground.
- e) Adjust T<sub>1018</sub>, T<sub>1019</sub> and T<sub>1020</sub> for a maximum reading on the voltmeter scale.

#### 9) Squelch Adjustment

- a) Set the MODE switch to FM.
- b) Set the front panel SQL control to the fully clockwise position.
- c) Apply a 0 dB $\mu$  (1  $\mu$ V) signal with  $\pm$ 3.5 kHz deviation at 1 kHz to the antenna jack.
- d) Adjust VR<sub>1001</sub> to the point where the squelch just opens.

## TRANSMITTER SECTION

Unless otherwise indicated, always perform the transmitter alignment with a dummy load connected to the antenna jack. If the AFP circuits are being aligned, an improper load impedance at a critical time could result in the destruction of the final amplifier module.

#### 1) Bandpass Filter Adjustment

- a) Set the MODE switch to USB or LSB.
- b) Connect a sweep generator to the source of Q<sub>3004</sub>, and set the frequency of the sweep generator to 435 MHz (Model X; 445 MHz).
- c) Unplug the plug connected to J<sub>3006</sub>, and temporarily terminate J<sub>3006</sub> with a 50 ohms resistor.
- d) Connect an oscilloscope to the terminated J<sub>3006</sub>, through a detector.
- e) Close the PTT switch and adjust TC<sub>3004</sub>, TC<sub>3005</sub>, TC<sub>3006</sub> and CV<sub>3003</sub>, until the scope pattern illustrated in Figure 4 is obtained.

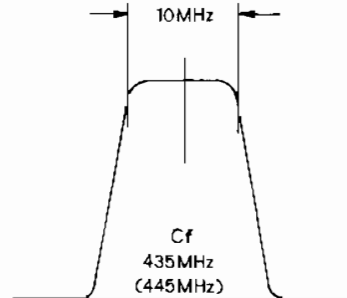

Figure 4

#### 2) Mixer/Interstage Alignment

- a) Tune the transceiver to 435 MHz (Model X; 445 MHz), and set the MODE switch to CW.
- b) Connect a UHF dummy load/power meter to the antenna jack, and connect a CW key to the key jack on the transceiver.
- c) Rotate VR<sub>1009</sub> fully clockwise, and rotate VR<sub>1008</sub> fully counterclockwise.
- d) Close the key and adjust T<sub>1012</sub>, T<sub>1013</sub>, T<sub>1014</sub>, T<sub>1015</sub>, T<sub>1016</sub> and T<sub>1017</sub> for maximum deflection on the power meter.

### 3) CW Carrier Oscillator

- a) Connect a frequency counter to pin 1 of J<sub>1001</sub>.
- b) Set the MODE switch to CW and close the key.
- c) Adjust TC<sub>1004</sub> for a reading of 67.6093 MHz with a tolerance of  $\pm 100$  Hz.

### 4) ALC Adjustment

- a) Set the MODE switch to FM, and close the PTT switch.
- b) Adjust VR<sub>1008</sub> for an output of 10 watts on the power meter.

### 5) PO Meter Adjustment

- a) Set the MODE switch to FM, and close the PTT switch.
- b) Adjust VR<sub>2003</sub> to illuminate 9 LED's on the S/PO meter.

### 6) AFP Adjustment

- a) Connect a DC voltmeter to pin 6 of J<sub>1009</sub> on the Main Unit and ground. Connect a DC ammeter (full scale: 10A) to the DC line from the power supply.
- b) Set the MODE switch to FM and close the PTT switch.
- c) Adjust VR<sub>2001</sub> for minimum indication on the DC voltmeter. Now return to RX.
- d) Remove the dummy load from the antenna jack. Close the PTT switch, and adjust VR<sub>1009</sub> so the reading on the ammeter goes down to less than 3 amps.

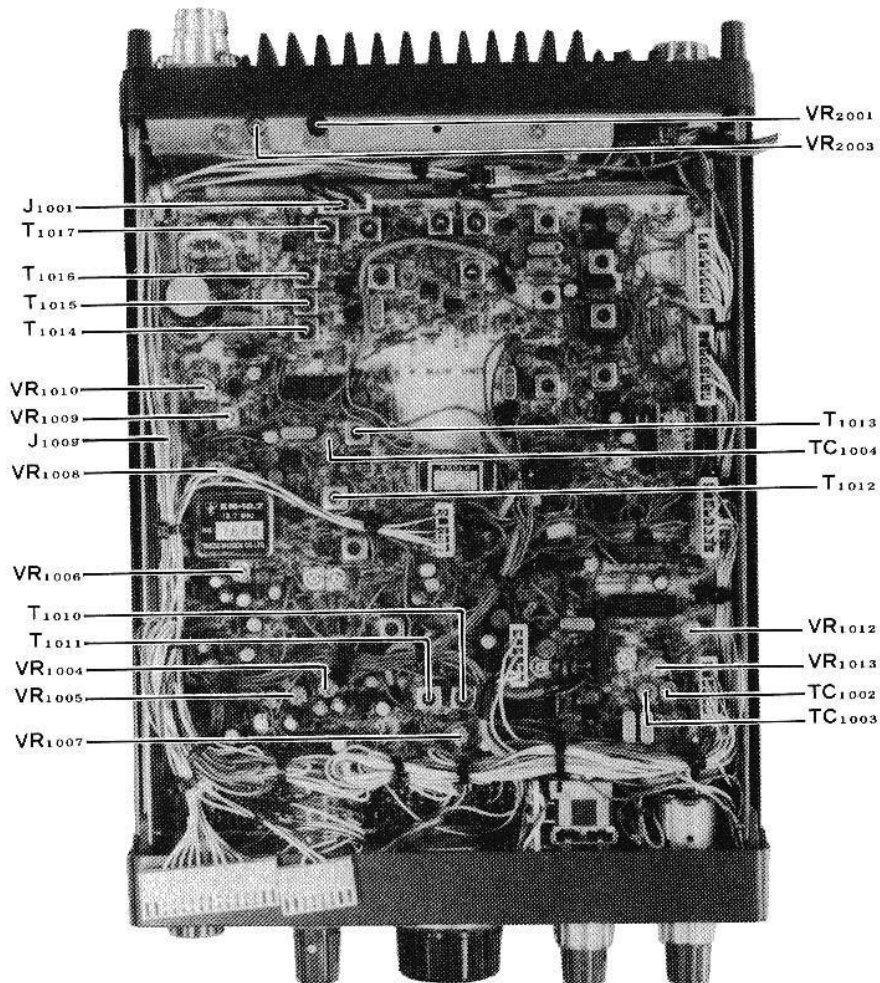

ALIGNMENT AND TEST POINTS FOR TRANSMITTER

## 7) Low Power Output Setting

- a) Set the HI/LOW switch to the LOW position, and key the transmitter in the FM mode.
- b) Adjust VR<sub>1010</sub> for an output of 1 watt on the wattmeter.

## 8) FM Modulator Adjustment

- a) Refer to Fig. 5, and set up the transceiver and test equipment as shown.
- b) Set VR<sub>1005</sub>, located on the Main Unit, to the center of its range, and apply a 1 kHz, 15 mV signal from the audio generator to the mic jack.
- c) Adjust VR<sub>1006</sub> for a deviation of  $\pm 4.5$  kHz while observing the signal waveform on the scope.
- d) Now reduce the audio generator output level to 1.5 mV, and adjust VR<sub>1005</sub> for a deviation of  $\pm 3.5$  kHz. Check to see that the waveform on the scope is not distorted.
- e) Turning the audio generator on and off, make sure that the BUSY/MOD indicator illuminates along with the changing audio input.

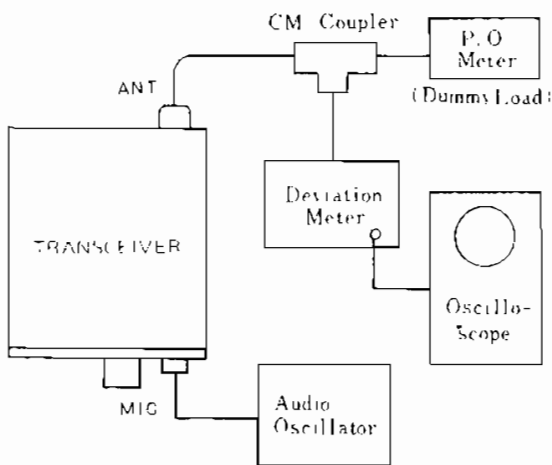

Figure 5

## 9) SSB Modulator Adjustment

### (A) Balanced Modulator Output Transformer Adjustment

- a) With a dummy load/wattmeter connected to the antenna jack, set the MODE switch to USB or LSB.
- b) Set VR<sub>1004</sub> to the center of its range, and apply a 1 kHz, 1 mV signal from the audio generator to the mic jack.
- c) Adjust T<sub>1010</sub> and T<sub>1011</sub> for maximum power output.

### (B) SSB Carrier Point Adjustment

- a) Apply a 1 kHz, 1.2 mV signal from the audio generator to the mic jack, and adjust VR<sub>1004</sub> for an output of 8 watts.
- b) Set the MODE switch to USB and the frequency of the audio generator to 400 Hz. Adjust TC<sub>1002</sub> for an output of 2 watts.
- c) Set the MODE switch to LSB, and the frequency of the audio generator to 400 Hz. Adjust TC<sub>1003</sub> for an output of 2 watts.

### (C) Carrier Balance Adjustment

- a) Temporarily short the mic input terminal of the mic jack (pin 8) to ground with a clip lead. Set the MODE switch to USB.
- b) While monitoring the carrier on a monitor receiver, adjust VR<sub>1007</sub> for a minimum S-Meter reading (or minimum signal level if no S-Meter reading occurs).
- c) Switch between USB and LSB, and compare the output levels with no modulation. Adjustment of VR<sub>1007</sub> may be necessary to achieve good carrier nulling on both modes.

## 10) CW Side Tone Frequency/Semi-break-in Delay Adjustment

- a) Adjust VR<sub>1013</sub> for the desired monitoring level on CW operation.
- b) Adjust VR<sub>1012</sub> for the desired CW VOX relay hang time.

## PLL SECTION

NOTE: The PLL circuit is very critical in its adjustment. Alignment must only be performed by an experienced technician. All alignments should be performed at a temperature within the range of 20° - 30°C, preferably, near the center of this range.

### 1) VCV Lines Adjustment

- a) Set the MODE switch to LSB, the STEP switch to "M", and tune the transceiver to 434.999.9 MHz (Model X; 444.999.9 MHz).
- b) Connect the DC probe of a VTVM to TP<sub>3001</sub>, and adjust the core of L<sub>3029</sub> for a reading of exactly 6.0V.

- c) Change the MODE switch to USB, and tune the transceiver to 434.999.9 MHz (Model x; 444.999.9 MHz).
- d) Connect the DC probe of the VTVM to TP<sub>3003</sub>, and adjust the core of L<sub>3001</sub> for a reading of exactly 6.5V on the VTVM.

### 2) Multiplier Stage Adjustment

- a) Set the MODE switch to LSB, the STEP switch to "M", and tune the transceiver to 434.999.9 MHz (Model X; 449.999.9 MHz).
- b) Connect the RF probe of the VTVM to TP<sub>3002</sub>, and adjust the core of T<sub>3005</sub> for a maximum reading on the VTVM. A nominal value is approximately 3V P-P.

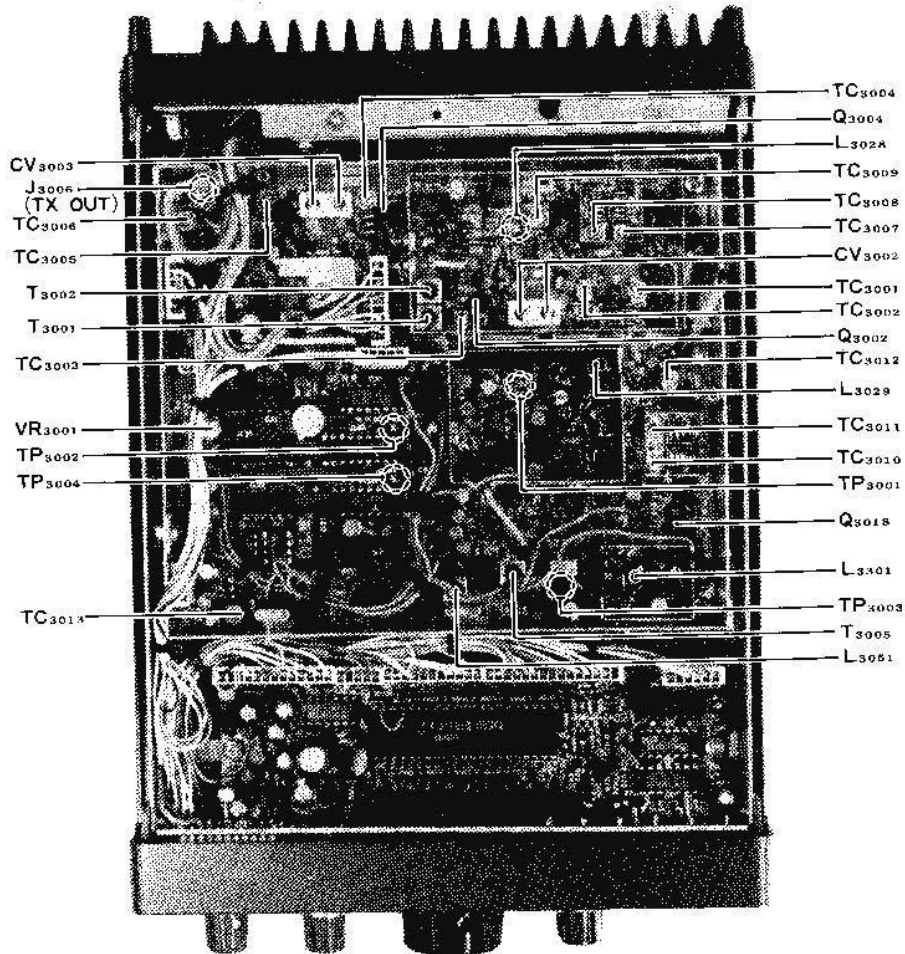

ALIGNMENT AND TEST POINTS FOR PLL

### 3) PLL Bandpass Filter Adjustment

- a) Connect a UHF sweep generator to gate 1 of  $Q_{3018}$ , and connect an oscilloscope, through a detector, to the gate of  $Q_{3002}$ .
- b) Set the frequency of the sweep generator to 367.4 MHz (Model X; 377.4 MHz).
- c) Adjust  $TC_{3007}$ ,  $TC_{3008}$ ,  $TC_{3009}$ ,  $TC_{3010}$ ,  $TC_{3011}$  and  $TC_{3012}$  until the scope pattern illustrated in Figure 6 is achieved.

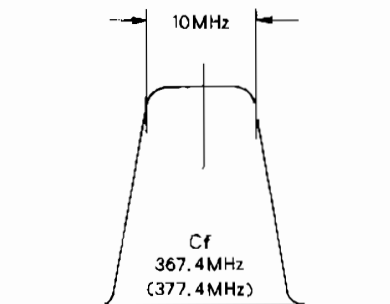

Figure 6

NOTE: In order to achieve the specified frequencies for the above alignment steps, some presetting of the display will be required (because the 10 Hz digit is not displayed). Push the F SET button, switch to USB, then set the STEP switch to "S". The precise frequency may then be set using the main dial.

### 4) PLL Reference Oscillator and PLL Local Oscillator Adjustment

- a) Connect a frequency counter to  $TP_{3002}$ .
- b) Adjust  $TC_{3013}$  for a reading of 9.996.667 MHz.
- c) Set the MODE switch to LSB, the STEP switch to "S" and tune the transceiver to 435.000.0 MHz (Model X; 445.000.0 MHz).
- d) Connect the frequency counter to the lead of  $L_{3028}$ , and adjust the core of  $L_{3051}$  for a reading of 367.388.50 MHz (Model X; 377.388.50 MHz) on the counter.
- e) Change the frequency to 434.999.9 MHz (Model X; 444.999.99 MHz), and adjust  $VR_{3001}$  for a reading of 367.388.49 MHz (Model X; 377.388.49 MHz).
- f) Repeat steps b through e a few times, until the proper frequency is obtained at each step.



Q1052,1066	G3090005	MPS-A13	R1010,1151	J02245821	Carbon film	1/4W SJ	820Ω
			R1173	J01245821	" "	" TJ	820Ω
			R1025,1060,1078, 1142,1145,1150, 1152,1156,1176, 1190,1196,1206, 1242,1244	J02245102	" "	" SJ	1kΩ
DJ001,1004--1008, 1011-1017, 1020-1025, 1028-1030,1034, 1036-1041, 1044-1049, 1051-1053	G2090027	<b>DIODE</b> Silicon ISS53	R1153	J01245102	" "	" TJ	1kΩ
			R1051,1149	J02245122	" "	" SJ	1.2kΩ
			R1172	J01245122	" "	" TJ	1.2kΩ
D1002,1003,1009, 1010,1042,1043, 1050	G2001880F	Germanium 1S188-FM	R1004,1013,1022, 1031,1047,1064, 1070,1098,1246, 1250	J02245152	" "	" SJ	1.5kΩ
D1018,1019	G2015550	Silicon 1S1555	R1030,1033 1035, 1048,1057,1059, 1074,1086,1088, 1090,1136,1144, 1162,1165,1197, 1199	J02245222	" "	" "	2.2kΩ
DJ031,1032	G2090001	" 10D1					
		<b>CRYSTAL</b>					
XJ001	H0102324	HC-18/U 56.910MHz	R1029,1040,1042, 1148	J02245332	" "	" "	3.3kΩ
X1002	H0100720A	" 10.245MHz					
X1003	H0100513	" 10.6993MHz	R1089,1090	J02245392	" "	" "	3.9kΩ
X1004 (US Model)	H0101983	" 7.3728MHz	R1008,1024,1045, 1063,1069, 1093-1095,1102, 1105,1118,1122, 1123,1133,1159, 1168,1180,1191, 1195,1235,1236, 1247,1249,1260, 1261	J02245472	" "	" "	4.7kΩ
X1004 (EU Model)	H0101982	" 7.168MHz					
X1005	H0100512	" 10.6985MHz					
X1006	H0100511	" 10.7015MHz					
		<b>FILTER</b>					
XF1001	H1102027	10M30B	R1036,1037,1140	J02245562	" "	" "	5.6kΩ
XF1002	H1102028	10F-2D	R1254,1263	J02245682	" "	" "	6.8kΩ
CF1001	H3900200	CFW455E (LFII-15S)	R1009,1011,1014, 1019,1046,1082, 1083,1087,1096, 1112,1114,1124, 1126,1157,1158, 1189,1193,1194, 1198,1204,1205, 1207,1210,1240, 1261,1265,1268, 1276,1281	J02245103	" "	" "	10kΩ
CF1002	H3900030	LFBI5					
		<b>CERAMIC DISCRIMINATOR</b>					
CD1001	H7900040	SFD-455S4					
		<b>MODULATOR MODULE</b>					
XM1001	H9500320	XM-10.7	R1081	J01245103	" "	" TJ	10kΩ
			R1053,1097,1129	J02245123	" "	" SJ	12kΩ
			R1054,1075,1130, 1131,1227,1228, 1231	J02245153	" "	" "	15kΩ
		<b>RESISTOR</b>					
R1138	J02245100	Carbon film 1/4W SJ 10Ω	R1084,1103,1252, 1264	J02245183	" "	" "	18kΩ
R1006,1018,1065, 1072,1106,1164, 1169,1170,1174, 1175,1177,1178, 1186-1188,1237, 1269,1270	J02245560	" " " " 56Ω	R1038,1044,1104, 1109,1137,1141, 1161,1163,1184, 1185,1211,1212, 1232,1266,1267, 1274,1275	J02245223	" "	" "	22kΩ
R1066,1262	J01245560	" " " TJ 56Ω					
R1012,1015,1016, 1049,1073,1099, 1101,1132,1135, 1139,1143,1155, 1160,1181,1209, 1245,1248,1251, 1255,1259,1279	J02245101	" " " SJ 100Ω	R1003,1021,1062, 1068,1167,1182, 1257	J02245273	" "	" "	27kΩ
			R1091,1092,1107, 1137,1200,1215, 1223,1239	J02245473	" "	" "	47kΩ
R1005,1017,1023, 1071	J02245151	" " " " 150Ω	R1055,1111,1219	J02245563	" "	" "	56kΩ
			R1125	J02245683	" "	" "	68kΩ
R1027,1043,1077, 1110,1113,1146, 1154,1208	J02245221	" " " " 220Ω	R1076	J02245823	" "	" "	82kΩ
			R1002,1020,1061, 1067,1115,1127, 1128,1166,1183, 1201,1203,1220, 1221,1243,1277	J02245104	" "	" "	100kΩ
R1052	J02245331	" " " " 330Ω					
R1080,1119,1179, 1253,1271	J02245471	" " " " 470Ω					
R1007,1056,1273	J02245561	" " " " 560Ω	R1039,1041,1116, 1282	J02245154	" "	" "	150kΩ

R1026,1032,1050,1218,1238	J02245224	Carbon film 1/4W SJ 220kΩ	C1075,1076	K00175101	Ceramic 50WV SL 100pF (DD105SL101J50V02)
R1028,1100,1134,1147,1256	J02245334	" " " " 330kΩ	C1136,1138	K00175221	" " " 220pF (DD107SL221J50V02)
R1120,1202,1258	J02245474	" " " " 470kΩ	C1050,1203	K00175331	" " " 330pF (DD107SL331J50V02)
R1079,1085,1192,1213,1230	J02245105	" " " " 1MΩ	C1137	K00175471	" " " 470pF (DD109SL471J50V02)
R1217	J01245105	" " " TJ 100kΩ	C1014,1018,1019,1047,1056,1077,1084,1087,1094,1095,1132,1133,1139,1153,1155,1156,1158-1161,1163-1165,1175,1185,1186,1193,1214,1216,1224-1226,1228 1230	K12171102	" " E 0.001μF (DD105E102P50V02)
R1001	J02245225	" " " SJ 2.2MΩ			
R1214,1229	J02245335	" " " " 3.3MΩ			
		<b>THERMISTOR</b>			
TH1001	G9090001	SDT-250			
		<b>POTENTIOMETER</b>			
VR1010	J51730472	P6-S3NA 4.7kΩ	C1003,1004,1006,1009,1015,1016,1020,1022,1066 1068,1071,1072,1074,1089,1107,1113,1115,1118-1121,1125,1126,1127,1131,1140 1142,1149-1151,1167,1188,1194,1196,1197,1205,1207,1210,1213,1217-1219,1221 1223,1227,1238,1239	K14170103	" " FZ 0.01μF (DD106FZ103Z50V02)
VR1001	J51730103	" 10kΩ			
VR1005	J51745103	H0651A013-10KB			
VR1002	J51730473	P6-S3NA 47kΩ			
VR1004	J51745473	H0651A017-47KB			
VR1007	J51745104	H0651A019-100KB			
VR1012	J51745154	H0651A020-150KB			
VR1003	J51730474	P6-S3NA 470KΩB			
VR1011	J51730104	P6-S3NA 100KΩB			
		<b>CAPACITOR</b>			
C1007,1145	K00172020	Ceramic 50WV SL 2pF (DD104SL020C50V02)	C1040,1049,1091,1109	K19149001	" 25WV 0.001μF (UAT04X102K-L05AE)
C1117	K00172030	" " " 3pF (DD104SL030C50V02)	C1041,1043,1045,1102	K19149009	" " 0.0047μF (UAT05X472K-L05AE)
C1064	K00172040	" " " 4pF (DD104SL040C50V02)	C1090	K19149011	" " 0.0068μF (UAT05X682K-L05AE)
C1143	K02172040	" " CH 4pF (DD104CH040C50V02)	C1023,1108,1169,1177-1179,1235	K19149013	" " 0.01μF (UAT05X103K-L05AE)
C1027,1130	K00172050	" " SL 5pF (DD104SL050C50V02)	C1042,1079	K19149017	" " 0.022μF (UAT06X223K-L45AE)
C1001,1008,1146,1147	K02173060	" " CH 6pF (DD104CH060D50V02)	C1024,1025,1199,1200,1201,1208,1236	K19149021	" " 0.047μF (UAT08X473K-L45AE)
C1231	K00173070	" " SL 7pF (DD104SL070D50V02)	C1182	K19149025	" " 0.1μF (UAT13X104K-L46AE)
C1005,1152	K02173080	" " CH 8pF (DD104CH080D50V02)	C1044,1048,1055,1184,1242	K40179002	Electrolytic 50WV 0.1μF (50RC2-R1)
C1017	K02175150	" " " 15pF (DD104CH150J50V02)	C1070,1073,1092,1097-1099,1101,1103,1104,1110-1112,1204,1211,1220,1234	K40170105	" " 1μF (50RL1)
C1116	K02173150	" " SL 15pF (DD104SL150D50V02)	C1162,1176	K40140475	" 25WV 4.7μF (25RL4R7)
C1122	K06175150	" " UJ 15pF (ECC-D1H150JU)	C1039,1051,1054,1069,1080,1081,1093,1096,1100,1106,1114,1157,1206,1209	K40120106	" 16WV 10μF (16RL10)
C1026,1065,1144,1148,1241	K00175220	" " SL 22pF (DD104SL220J50V02)	C1166	K40129008	" 16WV RE 33μF (16RE33)
C1129	K00175270	" " " 27pF (DD104SL270J50V02)	C1187	K40129019	" " RC 1000μF (16RC1000)
C1170,1171	K00175330	" " " 33pF (DD104SL330J50V02)	C1168	K70167104	Tantalum 25WV 0.1μF (CS15E1V0R1M)
C1012	K06175330	" " UJ 33pF (DD104UJ330J50V02)	C1232	K70167474	" " 0.47μF (CS15E1VR47)
C1002	K00175470	" " SL 47pF (DD104SL470J50V02)	C1212,1233	K70147105	" " 1μF (CS15E1E010M)
C1010	K06175470	" " UJ 47pF (ECC-D1H470JU2)			
C1088,1240	K00175560	" " SL 56pF (DD104SL560J50V02)			

C1078,1174	K70167225	" " 2.2μF (CS15E1V2R2M)	R2005	J02245560	<b>RESISTOR</b> Carbon film 1/4W SJ 56Ω
C1173	K70127475	" 16WV 4.7μF (CS15E1C4R7M)			
C1086,1124	K51176101	Styrol 50WV 100pF (S0SU101K)	VR2001	J50716201	<b>POTENTIOMETER</b> RV8-FAS 200Ω
C1030,1031,1085 1123	K51176151	" 25WV 150pF (S0SU151K)	VR2003	J50716503	RV8-FAS 50kΩ
					<b>CAPACITOR</b>
			C2001,2004,2005, 2008,2009,2012, 2018-2023	K12171102	Ceramic 50WV E 0.001μF (DD105E102P50V02)
TC1001 1004	K91000075	<b>TRIMMER CAPACITOR</b> TZ03R200A 20pF	C2002,2006,2010	K14170103	" " FZ 0.01μF (DD106FZ103Z50V02)
			C2013	K00179001	" " SL 0.5pF (DD104SL0R5C50V02)
L1002	L1190004	<b>INDUCTOR</b> FL4H-R68M 0.68μH	C2024	K02179001	" " CH 1pF (DD104CK010C50V02)
L1010,1011	L1190006	FL4H-1R2M 1.2μH	C2026,2027	K02179003	" " " 2pF (DD104CK020C50V02)
L1012	L1190009	FL4H-3R3M 3.3μH	C2016,2017	K00172040	" " SL 4pF (DD104SL040C50V02)
L1009	L1190027	FL5H-390K 39μH	C2015	K00173060	" " " 6pF (DD104SL060D50V02)
L1003,1013,1014	L1190020	FL5H-151K 150μH	C2014	K00173070	" " " 7pF (DD104SL070D50V02)
L1008	L1190038	FL5H-271K 270μH	C2025	K02173090	" " CH 9pF (DD104CH090D50V02)
L1004	L1190017	FL5H-102K 1mH			
L1006,1007	L1190040	S4-102K 1mH			
L1001	L0020417				
					<b>AF CHOKE COIL</b>
CH1001	L2030067A	FR14/7/5-2001F			
					<b>TRANSFORMER</b>
T1001 1004, 1014-1017	L0020825				<b>INDUCTOR</b>
T1005-1009,1012, 1013,1018 1020	L0020187		L2001-2003,2007	L1020673	
T1010	L0020910		L2004	L0020903	
			L2005,2006	L0020767	
			L2008	L0020342	
					<b>CONNECTOR</b>
J1001,1007	P0090050	5048-04A			<b>RELAY</b>
J1002-1004	P0090054	5048-07A	RL2001	M1590002	CX-1051
J1005,1006	P0090042	5048-05A		Q5000011	Wrapping Terminal C
J1008	P0090051	5048-06A			
J1009	P0090038	5048-12A	J2001 (with wire)	T9204010A	5240-061
					<b>RELAY</b>
RL1001	M1190006	221D012			
	L919000	Ferrite Beads RI 3x3-1			
	Q5000038	Terminal TP-I			
					<b>PLL UNIT</b>
			Symbol No.	Part No.	Description
			PB-2211	F0002211	Printed Circuit Board
				C0022110	PCB with Components
					<b>IC</b>
			Q3043	G1090084	78L05
			Q3042	G1090294	μPC7808H
Q2001	G1090341	<b>POWER MODULE</b> M57716	Q3009	G1090164	μPC2002H
			Q3013,3022,3023	G1090012	SN16913P
			Q3015,3025	G1090048	TC5081P
			Q3040,3041	G1090247	TC9122P
D2001-2003	G2090118	<b>DIODE</b> Schottky barrier 1SS97	Q3017	G1090296	HD10551
D2004	G2090027	Silicon 1SS53		G1090064	34024PCQM
D2005	G2090001	" 10D1	Q3031	G1090342	MB84024B

Q3032	G1090108	MC14518D		R3016	J01245681	Carbon film	1/4W TJ	680Ω
Q3035	G1090312	MC14504B		R3008,3027,3030, 3078,3101,3107, 3114,3116,3122	J02245102	" "	" SJ	1kΩ
Q3037-3039	G1090343	MC14094B						
				R3061,3067,3081, 3097	J02245152	" "	" "	1.5kΩ
		<b>FET</b>						
Q3010	G3090035	2SK19TM-GR		R3039,3099	J02245222	" "	" "	2.2kΩ
Q3002,3004	G3801250	2SK125		R3110	J02245332	" "	" "	3.3kΩ
Q3011,3018,3021	G4800730Y	3SK73-Y		R3026,3033	J02245472	" "	" "	4.7kΩ
Q3001	G4800970	3SK97		R3077	J01245562	" "	" TJ	5.6kΩ
				R3068,3082	J02245562	" "	" SJ	5.6kΩ
				R3001,3043,3048, 3051,3070,3088, 3112,3115,3119, 3139,3141	J02245103	" "	" "	10kΩ
		<b>TRANSISTOR</b>						
Q3028,3033	G3107331P	2SA733-P						
Q3012,3014,3016, 3024	G3305350B	2SC535-B						
Q3029,3030,3034, 3036	G3309451P	2SC945-P		R3053,3054,3072, 3073,3090,3091, 3117,3124,3128	J02245223	" "	" "	22kΩ
Q3006	G3314260	2SC1426		R3065,3105,3106, 3108,3109,3123, 3138	J02245473	" "	" "	17kΩ
Q3005,3007,3019, 3020	G3320260	2SC2026						
Q3008	G3324070	2SC2407		R3126,3127	J02245563	" "	" "	56kΩ
Q3026	G3090005	MPS-A13		R3044,3051,3060, 3066,3071,3089, 3111,3113	J02245104	" "	" "	100kΩ
		<b>DIODE</b>		R3096	J02245154	" "	" "	150kΩ
D3001,3004,3005	G2090033	Silicon MI-301		R3057	J02245224	" "	" "	220kΩ
D3002,3003	G2015550	" 1S1555		R3140	J02245334	" "	" "	330kΩ
D3007,3008,3010, 3011	G2090027	" 1SS53		R3132,3137	J20249213	Metallic film	" "	49.9kΩ
D3006,3009	G2090107	Varactor 1T25		R3131,3136	J20249212	" "	" "	100kΩ
D3012	G2090176	Zener HZ6L-A1		R3130,3135	J20249211	" "	" "	200kΩ
D3013-3016	G2090118	Shottky barrier 1SS97		R3133	J20249214	" "	" "	243kΩ
				R3129,3134	J20249210	" "	" "	402kΩ
		<b>CRYSTAL</b>						
X3002	H0102327	HC-18/U 5.3333MHz		VR3001	J51745474	POTENTIOMETER	H0651A	470KΩB
X3001 (LOW BAND)	H0102410A	HC-18/U 35.3928MHz (430-440MHz)						
X3001 (HIGH BAND)	H0102411	HC-18/U 36.4029MHz (440-450MHz)				<b>THERMISTOR</b>		
				TH3001	G9090008	31D26		
		<b>RESISTOR</b>				<b>CAPACITOR</b>		
R3047	J02245010	Carbon film 1/4W SJ 1Ω		C3014,3072	K00179001	Ceramic 50WV 0.5pF (DD104SL0R5C50V02)		
R3046	J01245229	" " " TJ 2.2Ω						
R3005,3121	J02245100	" " " SJ 10Ω		C3113	K00172010	" " " " 1pF (DD104SL010C50V02)		
R3018	J01245180	" " " TJ 18Ω						
R3028	J02245330	" " " SJ 33Ω		C3191	K00172020	" " " SL 2pF (DD104SL020C50V02)		
R3009,3010,3021, 3087,3118	J02245560	" " " " 56Ω		C3045,3068,3097, 3117	K02179004	" " " CH 3pF (DD104CH030C50V02)		
R3035,3055,3059, 3074,3076,3092, 3094,3095,3104	J02245101	" " " " 100Ω		C3048,3104,3105	K02172040	" " " " 4pF (DD104CH040C50V02)		
R3004	J02245121	" " " " 120Ω		C3073	K00172040	" " " SL 4pF (DD104SL040C50V02)		
R3029,3083	J01245221	" " " TJ 220Ω						
R3038,3057,3062, 3084,3098	J02245221	" " " SJ 220Ω		C3074,3080,3122	K00172050	" " " " 5pF (DD104SL050C50V02)		
R3045	J10276221	Carbon composition 1/2WGK 220Ω		C3064	K06173060	" " " UJ 6pF (ECC-D111060DU)		
R3017,3019,3140	J01245331	Carbon film 1/4W TJ 330Ω		C3011	K02173060	" " " CII 6pF (DD104CH060D50V02)		
R3025,3049	J02245331	" " " SJ 330Ω						
R3079	J02245471	" " " " 470Ω		C3015,3061	K02173080	" " " " 8pF (DD104CH080D50V02)		
R3011,3012,3042, 3069,3100	J02245681	" " " " 680Ω						

C3035,3101	K02173100	Ceramic 50WV CII 10pF (DD104CH100D50V02)	C3054,3157	K40170105	Electrolytic 50WV 1μF (50RL1)
C3065,3148	K06173100	" " UJ 10pF (ECC-D1H100DU)	C3034,3037,3039, 3086,3108,3136, 3139,3156,3162, 3165,3170	K40120106	" 16WV 10μF (16RL10)
C3188,3189	K00173100	" " SL 10pF (DD104SL100D50V02)			
C3152	K02175102	" " CH 12pF (DD104CII120J50V02)	C3067	K40129012	" " 10μF (16RC2-10)
C3092,3093,3123, 3124	K00175150	" " SL 15pF (DD104SL150J50V02)	C3176	K40129002	" " 47μF (16RE47)
C3111,3158,3185	K02179009	" " CH 22pF (DD104CII220J50V02)	C3056,3144,3163, 3179,3181	K40109001	" 10WV 100μF (10RE100)
C3125	K00175270	" " SL 27pF (DD104SL270J50V02)			
C3001	K00175330	" " " 33pF (DD104SL330J50V02)			<b>TRIMMER CAPACITOR</b>
C3016,3017,3020, 3021	K00175390	" " " 39pF (DD104SL390J50V02)	TC3004	K91000060	ECV-1ZW 02X53N 2pF
C3025,3029,3030, 3082	K00175470	" " " 47pF (DD104SL470J50V02)	TC3001,3002, 3005,3007, 3008,3010, 3011	K91000059	" 04X53N 4pF
C3081,3128,3131, 3133	K00175560	" " " 56pF (DD104SL560J50V02)	TC3012	K91000055	" 06X53N 6pF
C3090,3132	K00175101	" " " 100pF (DD105SL101J50V02)	TC3003,3009,3014	K91000028	" 10X53N 10pF
C3159,3160	K00175151	" " " 150pF (DD104SL151J50V02)	TC3006	K91000029	" 20X53 20pF
C3003,3004,3006, 3009,3010,3012, 3013,3018,3019, 3024,3026,3028, 3031-3033,3036, 3038,3041,3044, 3046,3047,3049, 3051,3053,3055, 3060,3066, 3069-3071,3083, 3085,3089,3095, 3096,3098-3100, 3102,3103,3106, 3107,3109,3110, 3112,3114,3115, 3134,3137, 3145-3147,3153, 3154,3172,3175, 3177,3178,3180	K12171102	" " E 0.001μF (DD105E102P50V02)	TC3013	K91000075	TZ03R 200A 20pF
					<b>INDUCTOR</b>
			L3030	L1190108	FL3H-R68M 0.68μH
			L3054	L1190004	FL4H-R68M 0.68μH
			L3005,3037	L1190005	FL4H-1R0M 1μH
			L3052	L1190006	FL4H-1R2M 1.2μH
			L3047	L1190011	FL4H-4R7K 4.7μH
			L3033	L1190013	FL4H-6R8K 6.8μH
			L3032,3036,3048, 3049	L1190014	FL4H-100K 10μH
			L3035	L1190120	FL5H-471K 470μH
			L3034,3050,3053	L1190017	FL5H-102K 1mH
			L3029	L0020716	
			L3051	L0020825	
			L3001,3002,3012, 3018	L0020900	
			L3003,3006,3010, 3015,3025,3043	L1020672	
			L3004,3009,3011, 3013,3019,3020, 3021,3027,3031, 3038,3040,3045, 3046	L1020673	
C3075,3077,3079, 3091,3094,3116, 3118-3121,3126, 3127,3129,3130, 3135,3138,3143, 3151,3161,3167, 3186,3187,3190	K14170103	" " FZ 0.01μF (DD106FZ103Z50V02)	L3007,3008	L0020824	
C3084	K19149013	" 25WV 0.01μF (UAT05X103K-1.05AE)	L3016,3026,3039	L0020840	
C3155	K19149017	" " 0.22μF (UAT06X223K-L45AE)	L3017,3028	L0020474	
C3088,3142,3164, 3169,3173,3174	K19149021	" " 0.047μF (UAT08X473K-L45AE)	L3023,3024,3041, 3042	L0020902	
C3058	K19149025	" " 0.1μF (UAT13X104K-L46AE)	L3044	L0020901	
C3087	K70167474	Tantalum 35WV 0.47μF (CS15E1VR47)			
C3166	K70127475	" 16WV 4.7μF (CS15E1C4R7M)			<b>RESONATOR</b>
C3005,3027,3182, 3183,3184	K22170004	Ceramic chip 50WV 0.001μF (CYC12Y5V1H102)	CV3002,3003 (LOW BAND)	Q9000064	252MT-1001A (430-440MHz)
C3022,3023	K21170002	Feed thru 50WV 0.001μF (ECKY1H-102WF)	CV3002,3003 (HIGH BAND)	Q9000063	252MT-1003A (440-450MHz)
C3141	K54200002	Polycrystalline film 0.47μF (B32560-A1474-J)			<b>TRANSFORMER</b>
			T3003,3004	L0190007	

T3005	L0020345					<b>INDUCTOR</b>
T3001,3002	L0020825			L3301	L0020716	
				L3302	L1190108	FL3H-R68M 0.68μH
						<b>CONNECTOR</b>
J3001	P0090041	5048-03A			Q5000016	Terminal TP-E
J3002	P0090042	5048-05A				
J3003	P0090037	5048-08A				
J3004	P0090050	5048-04A				
J3005,3006	P1090210	TMP-JV				
						<b>PLL CONTROL UNIT</b>
	L9190001	Ferrite Beads RI 3x3-1		Symbol No.	Part No.	Description
				PB-2213A	F0002213A	Printed Circuit Board
					C0022130	PCB with Components
	Q5000016	Terminal TP-E				
	Q5000026	" TP-F				
						<b>IC</b>
				Q4001	G1090344	μPD1511-018
				Q4002,4021	G1090068	MC14011B
				Q4020	G1090126	MC14069UB
				Q4022	G1090174	MC14002B
				Q4027,4028	G1090084	78L05
						<b>VCO UNIT</b>
				Symbol No.	Part No.	Description
				PB-2212A	F0002212A	Printed Circuit Board
					C0022120	PCB with Components
						<b>TRANSISTOR</b>
				Q4003-4018,4033,4034	G3107331P /Q	2SA733P or Q
				Q4019,4025	G3309451P /Q	2SC945P or Q
Q3301	G3090035	FET 2SK19TM-GR		Q4026	G3309451K	2SC945K
				Q4029	G3313830R	2SC1383R
				Q4030	G3320020L	2SC2002L
				Q4032	G3327850E	2SC2785E
						<b>DIODE</b>
						<b>DIODE</b>
R3306	J02245101	RESISTOR Carbon film 1/4W SJ 100Ω		D4001-4008,4010,4012-4027,4034,4036,4054-4058	G2090027	Silicon 1SS53
R3305	J02245331	" " " " 330Ω				
R3301,3302,3303,3304	J02245473	" " " " 47kΩ		Q4033	G2001880F	Germanium 1S188FM
				Q4035	G2090143	Zener HZ11B-1
						<b>THERMISTOR</b>
TH3301	G9090008	31D26				
				X4001	H7900080	CERAMIC CSA 2.56MA
						<b>CAPACITOR</b>
C3305	K06172040	Ceramic 50WV UJ 4pF (ECC-D1H040CU)		R4044	J10276829	RESISTOR Carbon composition 1/2WGK 8.2Ω
C3307	K06172050	" " " " 5pF (ECC-D1H050CU)		R4042	J10276221	" " " " 220Ω
C3306	K02173070	" " " CH 7pF (DD104CH070D50V02)		R4043	J02245271	Carbon film 1/4W SJ 270Ω
				R4041	J02245331	" " " " 330Ω
C3304	K02173080	" " " " 8pF (DD104CH080D50V02)		R4039	J02245471	" " " " 470Ω
				R4046	J02245122	" " " " 1.2kΩ
C3308	K06175150	" " " UJ 15pF (ECC-D1H150JU)		R4047	J02245152	" " " " 1.5kΩ
				R4023	J02245222	" " " " 2.2kΩ
C3301-3303,3309	K12171102	" " " E 0.001μF (DD105E102P50V02)		R4037,4040	J02245472	" " " " 4.7kΩ
				R4006,4056	J02245103	" " " " 10kΩ
C3310	K40129012	Electrolytic 16WV RC-2 10μF (16RC2-10)		R4061	J01245103	" " " " TJ 10kΩ
				R4004	J02245153	" " " " SJ 15kΩ
				R4024-4026	J02245223	" " " " 22kΩ
				R4062	J01245223	" " " " TJ 22kΩ
				R4003	J02245273	" " " " SJ 27kΩ

R4057	J02245333	Carbon film 1/4W SJ 33kΩ			<b>IC</b>
R4029,4032	J02245393	" " " " 39kΩ	Q4031	G1090241	TA7612AP
R4007-4022	J02245473	" " " " 47kΩ			
R4045,4059	J02245563	" " " " 56kΩ			
R4001,4005,4025,4026,4033,4034,4038	J02245104	" " " " 100kΩ	Q4024	G3309451P/Q	<b>TRANSISTOR</b>
R4060	J01245104	" " " TJ 100kΩ			
R4027,4030	J02245334	" " " SJ 330kΩ			
R4028,4031	J02245684	" " " " 680kΩ			<b>DIODE</b>
R4002	J02245105	" " " " 1MΩ	D4028,4029 4030,4031,4032	G2090027	Silicon 1SS53
<b>BLOCK RESISTOR</b>					
PB4001	Q80000006				<b>LED</b>
PB4002	Q80000007		D4037-4041	G2090144	TLG226
			D4042,4043	G2090145	TLY226
			D4044-4046	G2090142	TLR226
			D4047,4049	G2090137	TLR205
			D4048,4050	G2090136	TLG205
<b>CAPACITOR</b>					
C4002,4003	K00175101	Ceramic 50WV SL 100pF (DD105SL101J50V02)			
C4005-4008	K10176471	" " B 470pF (DD104B471K50V02)			<b>RESISTOR</b>
C4010,4013,4016,4019,4020	K14170103	" " FZ 0.01μF (DD106FZ103Z50V02)	R4048	J02245471	Carbon film 1/4W SJ 470Ω
C4023	K50177152	Mylar " " 0.0015μF (50F2U152M)	R4052	J01245471	" " " TJ 470Ω
C4004	K50177103	" " " " 0.01μF (50F2U103M)	R4053	J02245102	" " " SJ 1kΩ
C4001	K50177473	" " " " 0.047μF (50F2U473M)	R4051	J01245122	" " " TJ 1.2kΩ
C4011,4012	K40170105	Electrolytic 50WV 1μF (50RL1)	R4036	J02245223	" " " SJ 22kΩ
C4009,4014,4015,4017,4018,4021,4022	K40120106	" 16WV 10μF (16RL10)	R4050	J02245393	" " " " 39kΩ
C4024	K40170106	" 50WV 10μF (50RL10)	R4049	J02245683	" " " " 68kΩ
			R4054	J01245224	" " " TJ 220kΩ
<b>BLOCK RESISTOR</b>					
			RB4003,4004	Q80000001	
			RB4005	Q80000002	
<b>SWITCH</b>					
			S4001-4004	N4090036	SUT-110
			S4005-4010	N5090003	KEF10901
<b>DC-DC CONVERTER</b>					
T4001	L3030078	MC-102C			
<b>CONNECTOR</b>					
J4001	P0090038	5048-12A			
J4002	P0090050	5048-04A			
J4003	P0090052	5048-10A			
J4004	P0090036	5048-14A			
J4005	P0090042	5048-05A			
<b>ACCESSORIES</b>					
			Symbol No.	Part No.	Description
				M3090028	Microphone YM-40
				T9002805	Power Cord Assembly
				Q0000005	Fuse 5A
				P0090034	P-2240
	Q5000007	F. Terminal		R0062300	Stand A
<b>ACC PLUG</b>					
				P0090188	EMCHUM0301W (Housing)
				Q5000034	EMCKNMOID (Contact)
<b>DISPLAY UNIT</b>					
Symbol No.	Part No.	Description			
PB-2139C	F0002139C	Printed Circuit Board			
	C0021390	PCB with Components			
<b>TONE IN PLUG</b>					
				P0090174	EMCHUM0401W (Housing)
				Q5000034	EMCKNMOID (Contact)
<b>DISPLAY TUBE</b>					
V4001	G6090008	LD8231/F1P9C5			

DISPLAY UNIT (NO. 40.) PB-2139

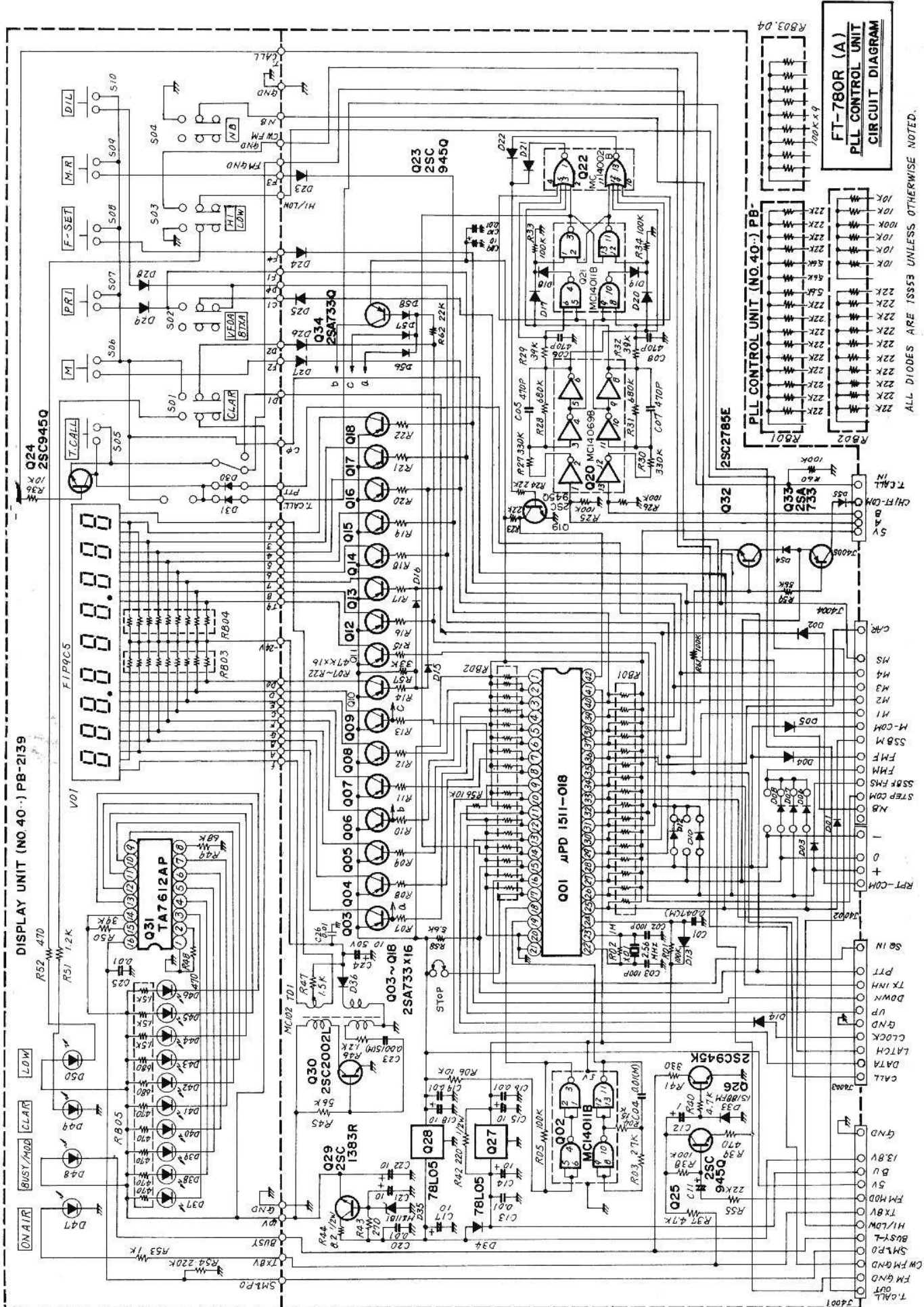

FT-780R (A)  
PLL CONTROL UNIT  
CIRCUIT DIAGRAM

ALL DIODES ARE 1SS53 UNLESS OTHERWISE NOTED.

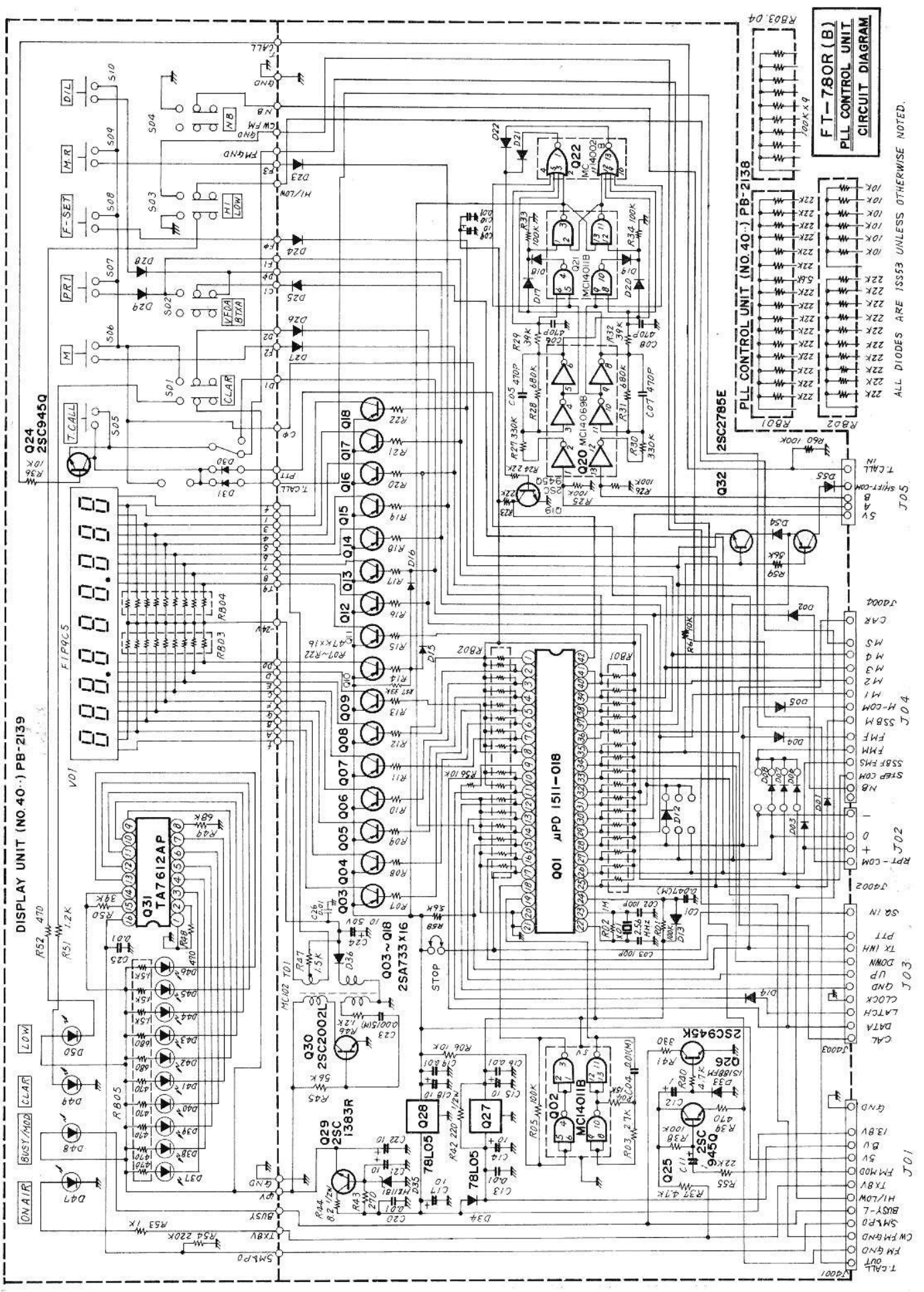

**FT-780R (B)  
PLL CONTROL UNIT  
CIRCUIT DIAGRAM**

ALL DIODES ARE 1SS53 UNLESS OTHERWISE NOTED.

DISPLAY UNIT (NO. 40) PB-2139

PLL CONTROL UNIT (NO. 40) PB-2138

DISPLAY UNIT (NO. 40-) PB-2139

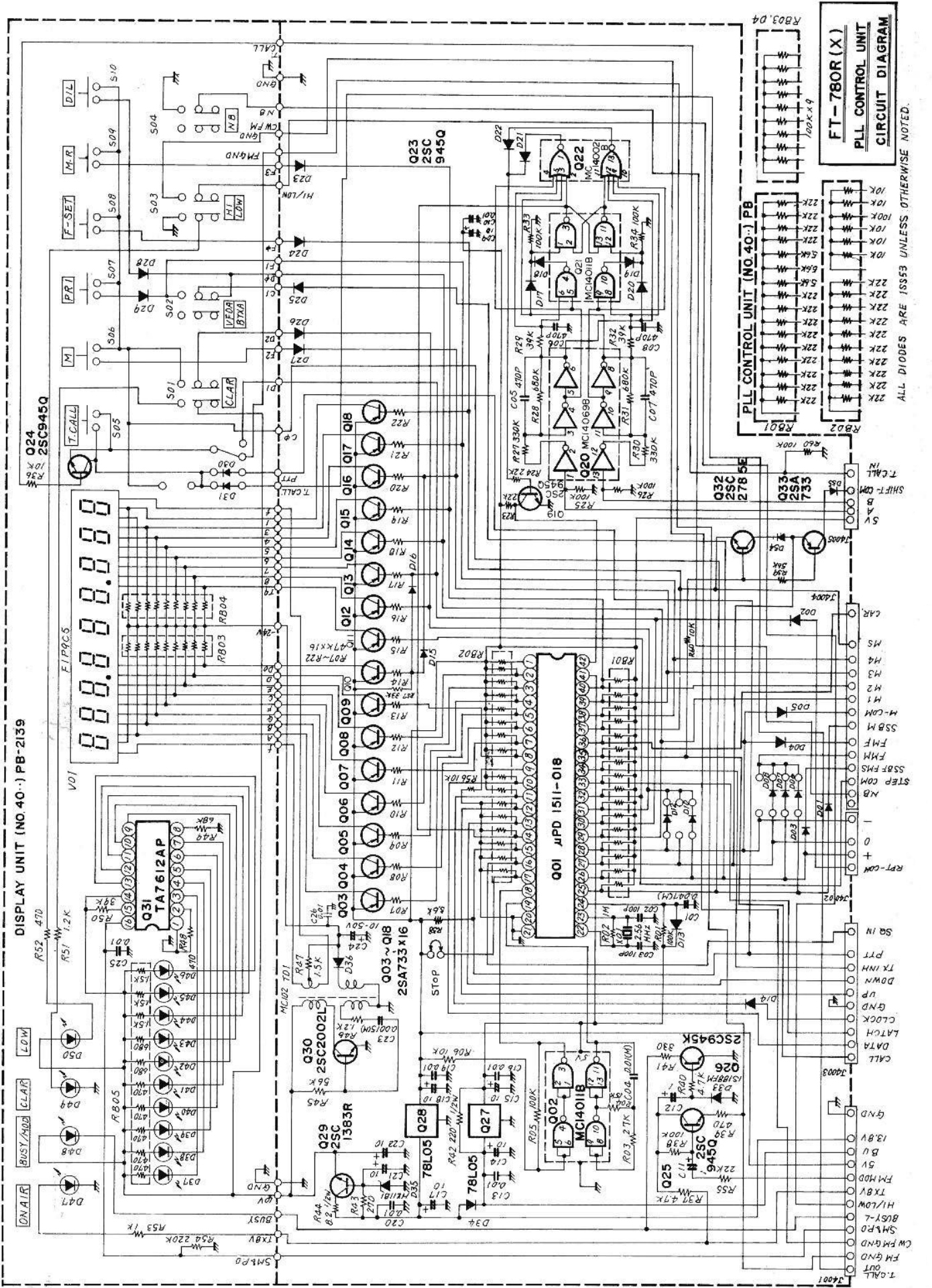

FT-780R(X)  
PLL CONTROL UNIT  
CIRCUIT DIAGRAM

ALL DIODES ARE 1SS53 UNLESS OTHERWISE NOTED.

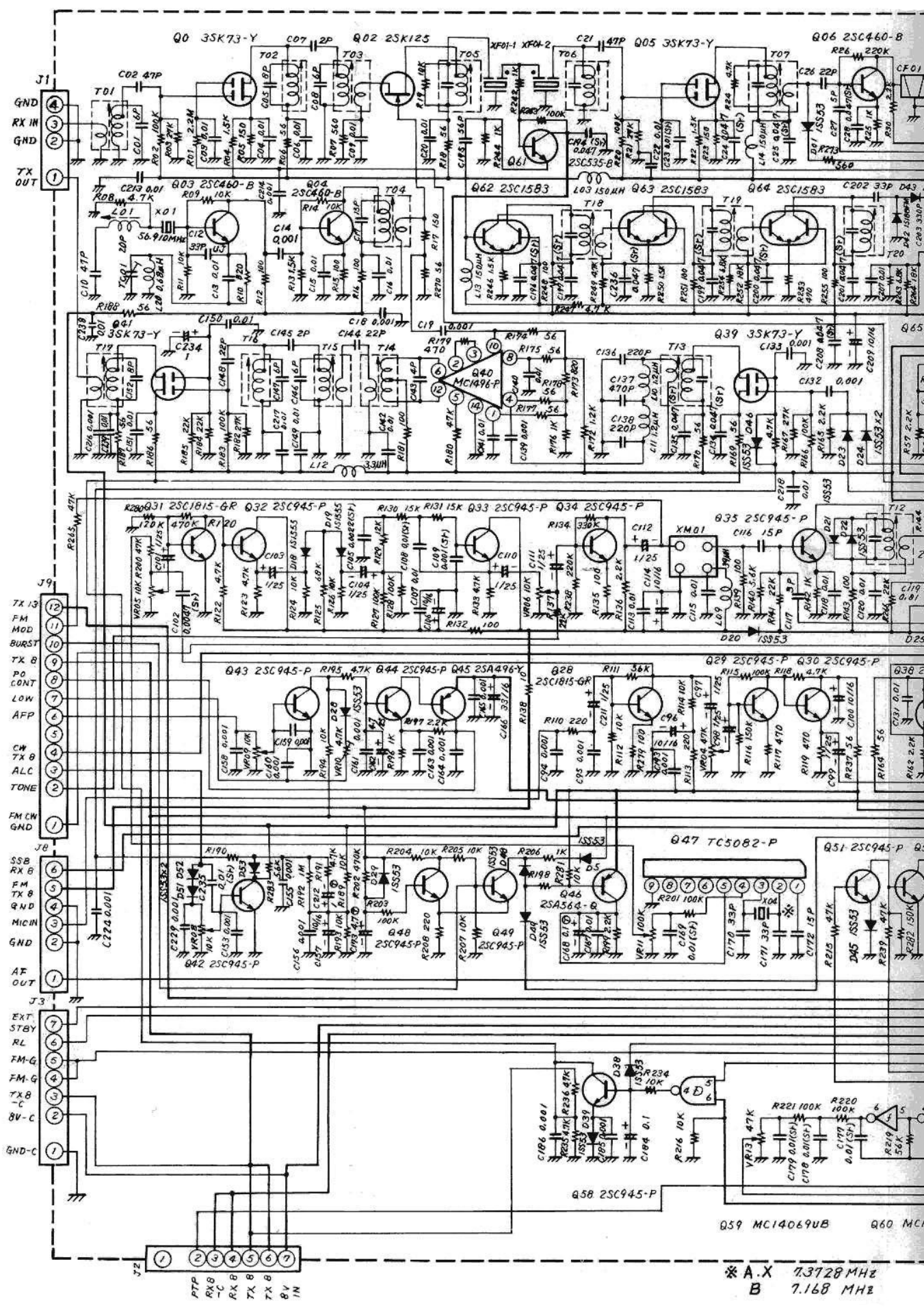

\* A.X 73728 MHz  
 B 7.168 MHz

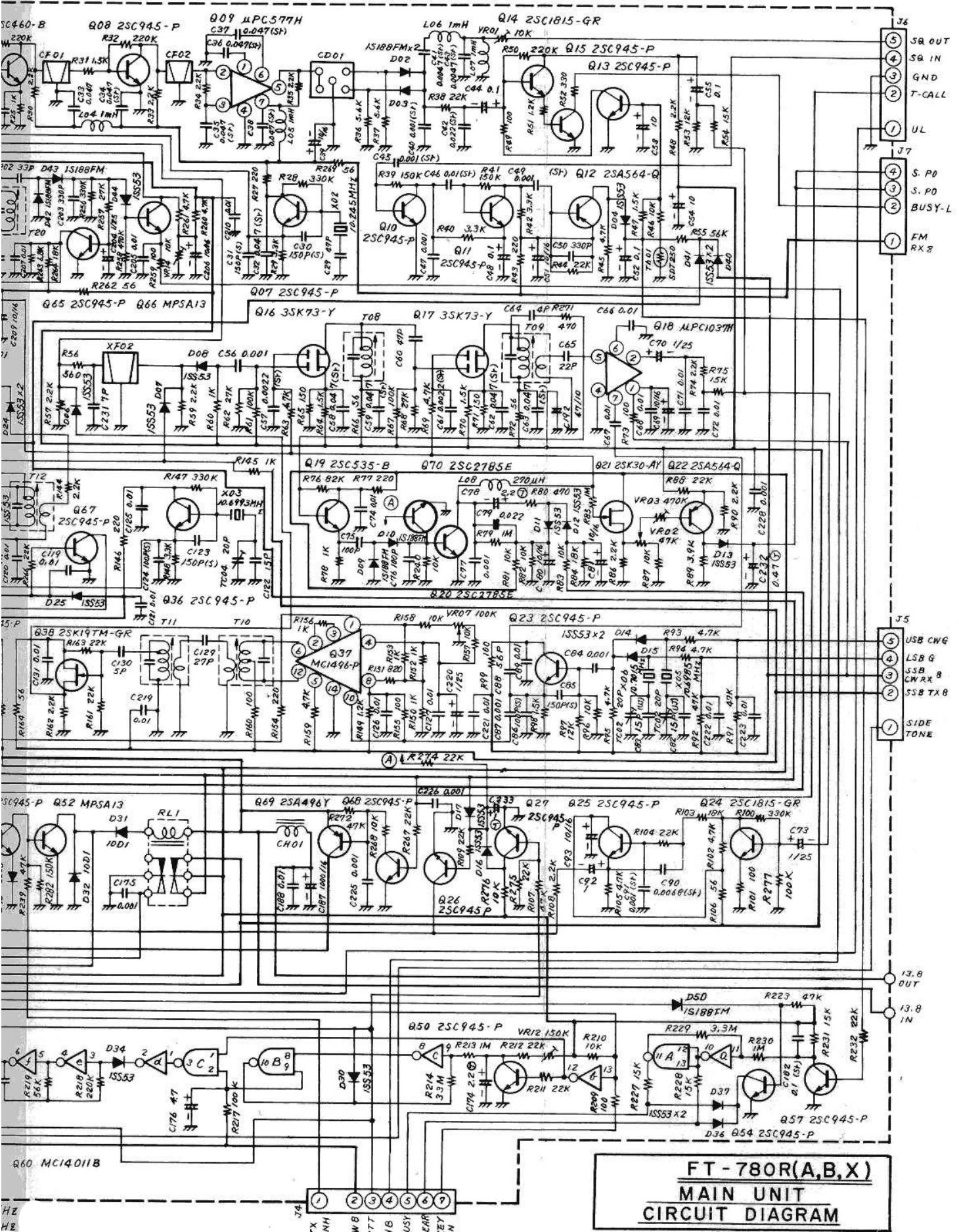

**FT-780R(A,B,X)**  
**MAIN UNIT**  
**CIRCUIT DIAGRAM**

**PLL CONTROL UNIT PB-2213A**  
**DISPLAY UNIT PB-2139C**

- |       |      |      |         |        |    |        |      |      |      |      |     |    |    |    |    |    |     |      |      |       |       |     |    |      |       |     |       |       |   |   |            |        |           |       |        |     |     |        |    |    |       |     |   |   |
|-------|------|------|---------|--------|----|--------|------|------|------|------|-----|----|----|----|----|----|-----|------|------|-------|-------|-----|----|------|-------|-----|-------|-------|---|---|------------|--------|-----------|-------|--------|-----|-----|--------|----|----|-------|-----|---|---|
| SV(3) | A(2) | B(1) | SHIFT-C | T.CALL | NB | STEP-C | SSBF | FM M | FM F | SSBM | M-C | M1 | M2 | M3 | M4 | M5 | CAR | CALL | DATA | LATCH | CLOCK | GND | UP | DOWN | TXINH | PTT | SQ IN | RPT-C | + | - | T.CALL OUT | FM GND | CW FM GND | SM PO | BUSY-L | LOW | TXB | FM MOD | 5V | BU | 13.8V | GND |   |   |
| 5     | 4    | 3    | 2       | 1      | 4  | 3      | 2    | 1    | 10   | 9    | 8   | 7  | 6  | 5  | 4  | 3  | 2   | 1    | 10   | 9     | 8     | 7   | 6  | 5    | 4     | 3   | 2     | 1     | 4 | 3 | 2          | 1      | 2         | 1     | 10     | 9   | 8   | 7      | 6  | 5  | 4     | 3   | 2 | 1 |

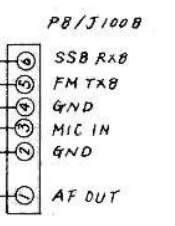
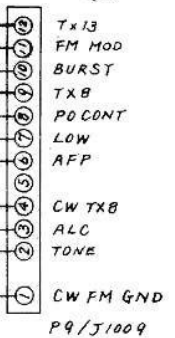
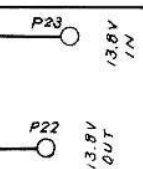
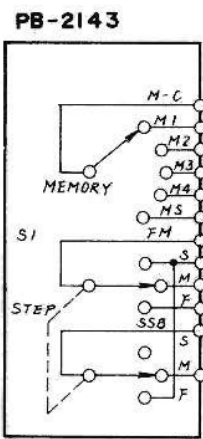
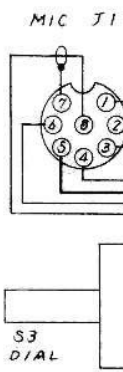

**MAIN UNIT**  
**PB-2209A**

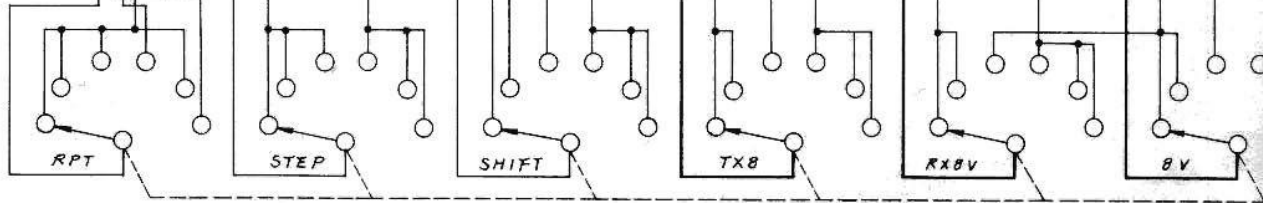
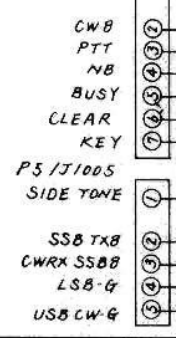
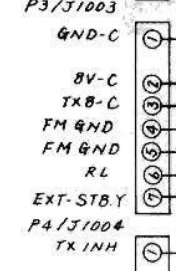
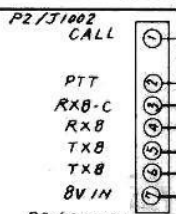
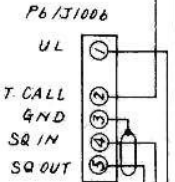
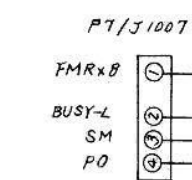

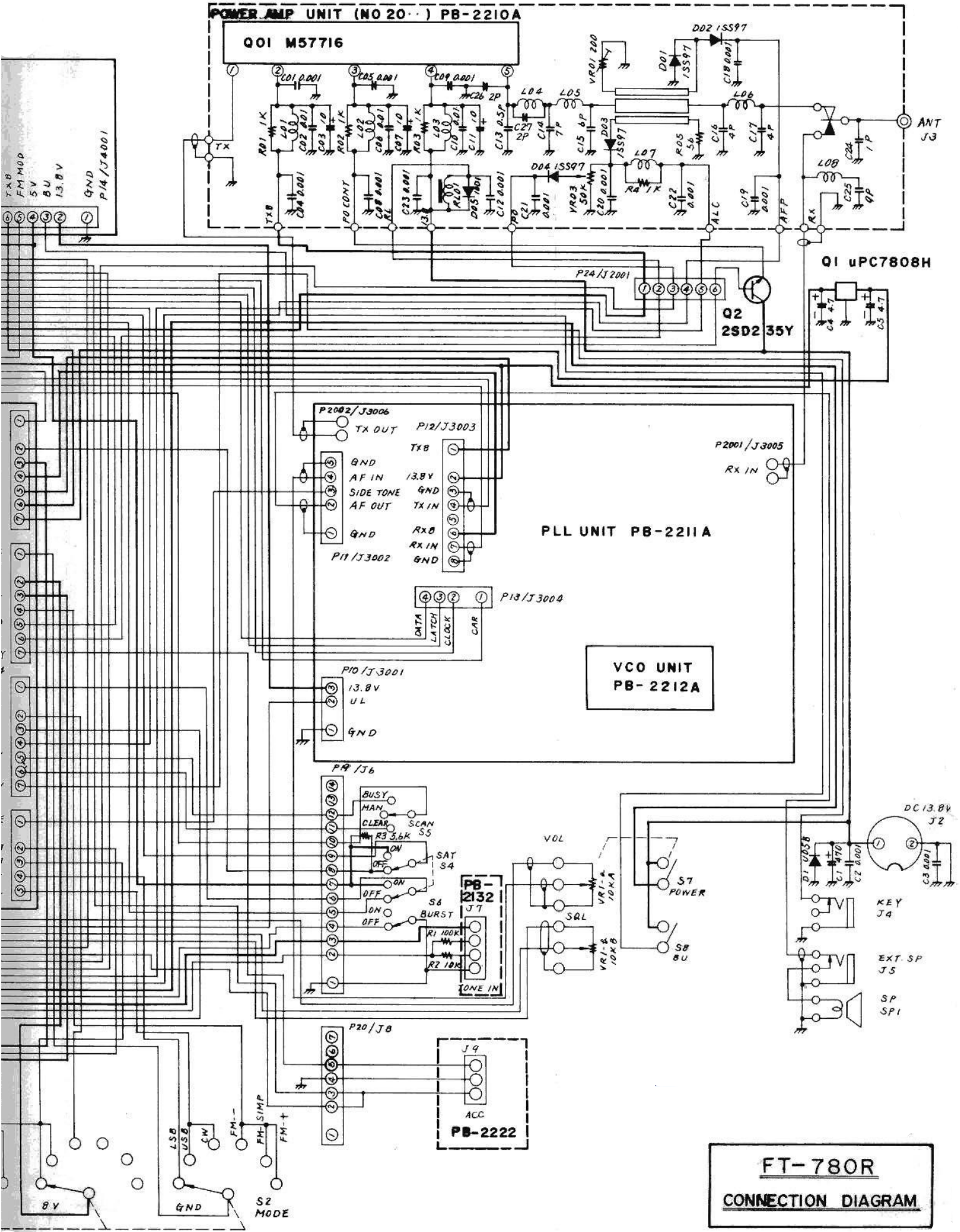

**POWER AMP UNIT (NO 20.. ) PB-2210A**

**Q01 M57716**

**Q1 uPC7808H**

**Q2 2SD235Y**

**PLL UNIT PB-2211A**

**VCO UNIT PB-2212A**

**PB-2222**

**FT-780R**

**CONNECTION DIAGRAM**

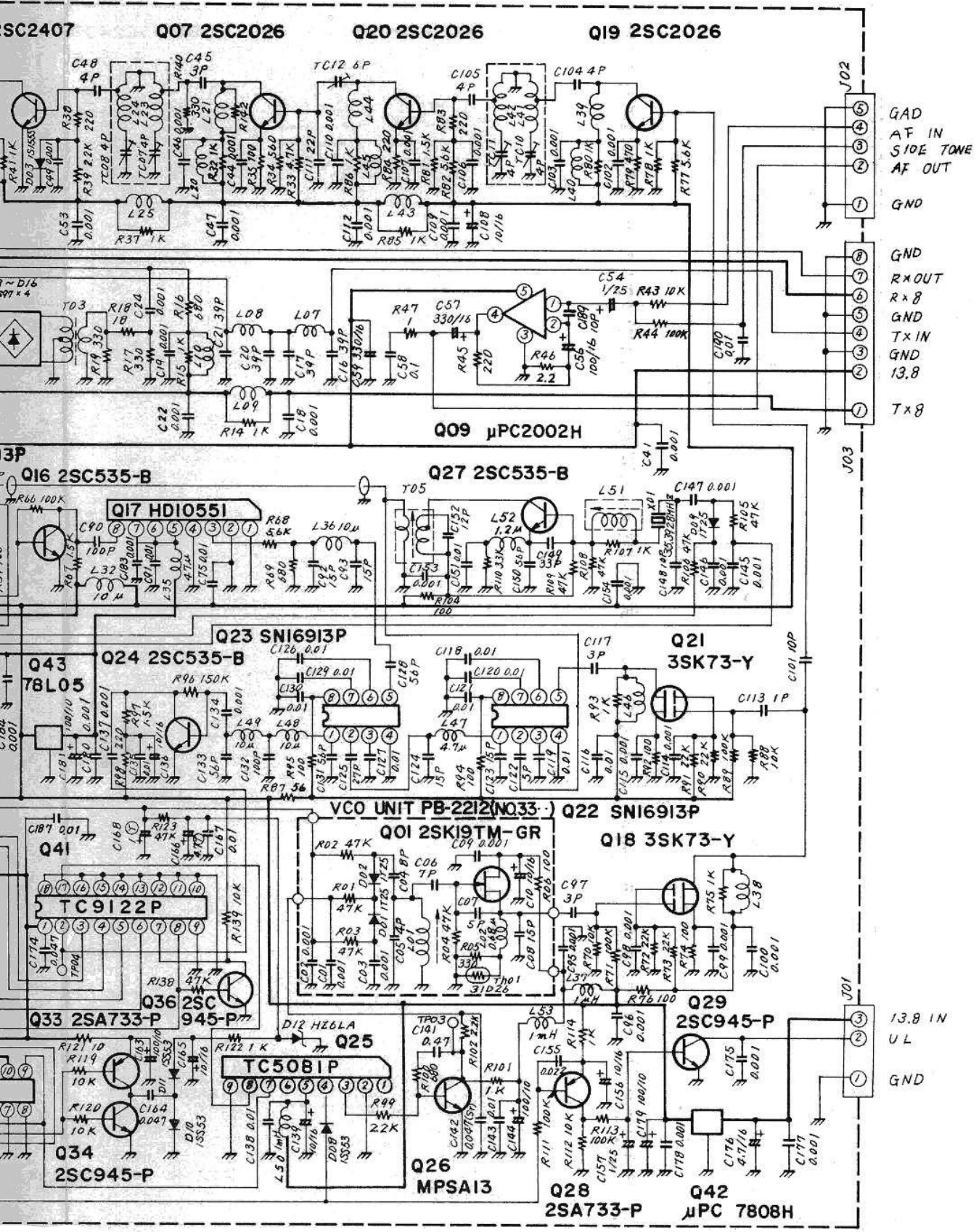

**FT-780R(A)**  
**PLL UNIT**  
**CIRCUIT DIAGRAM**

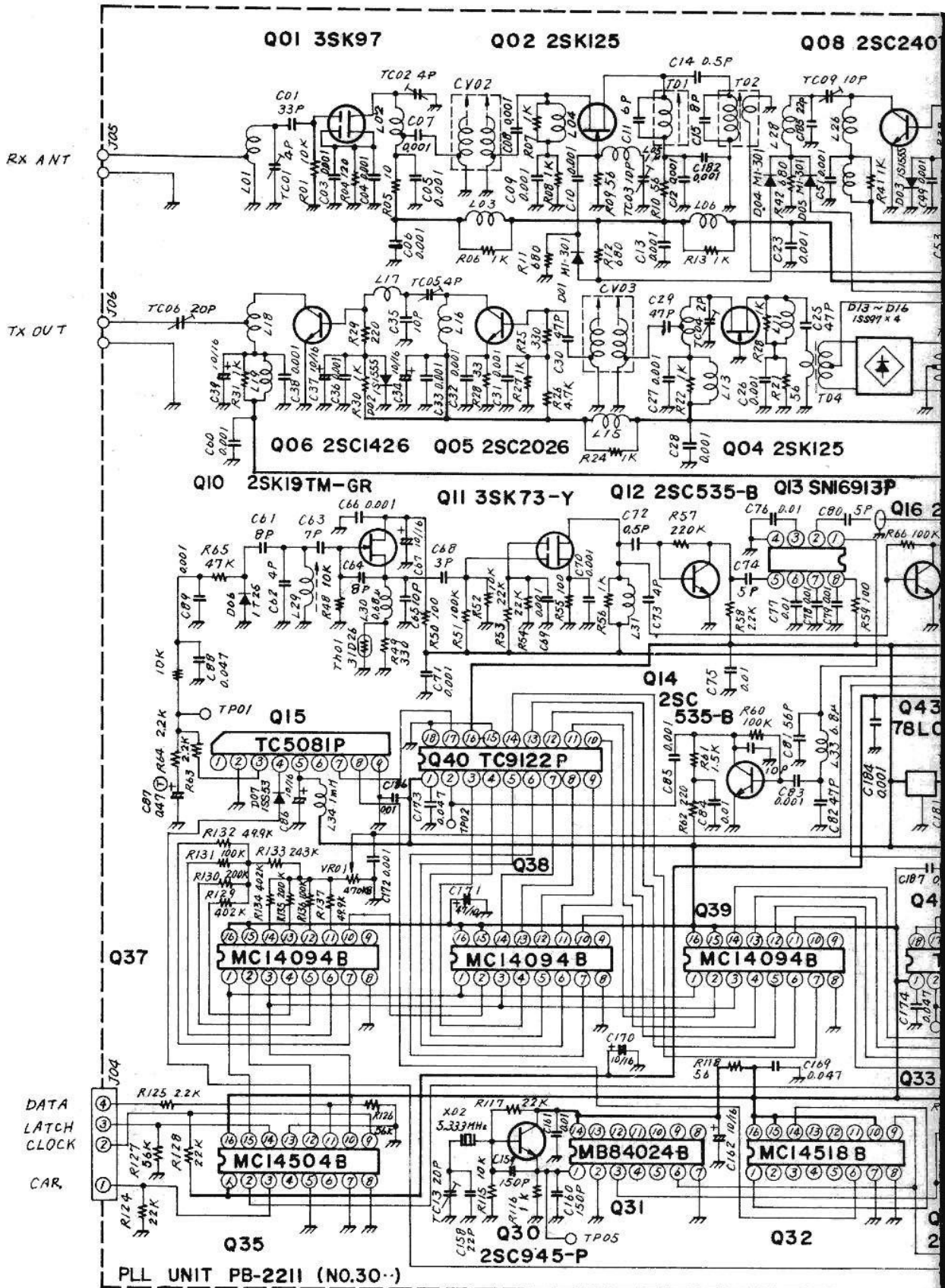

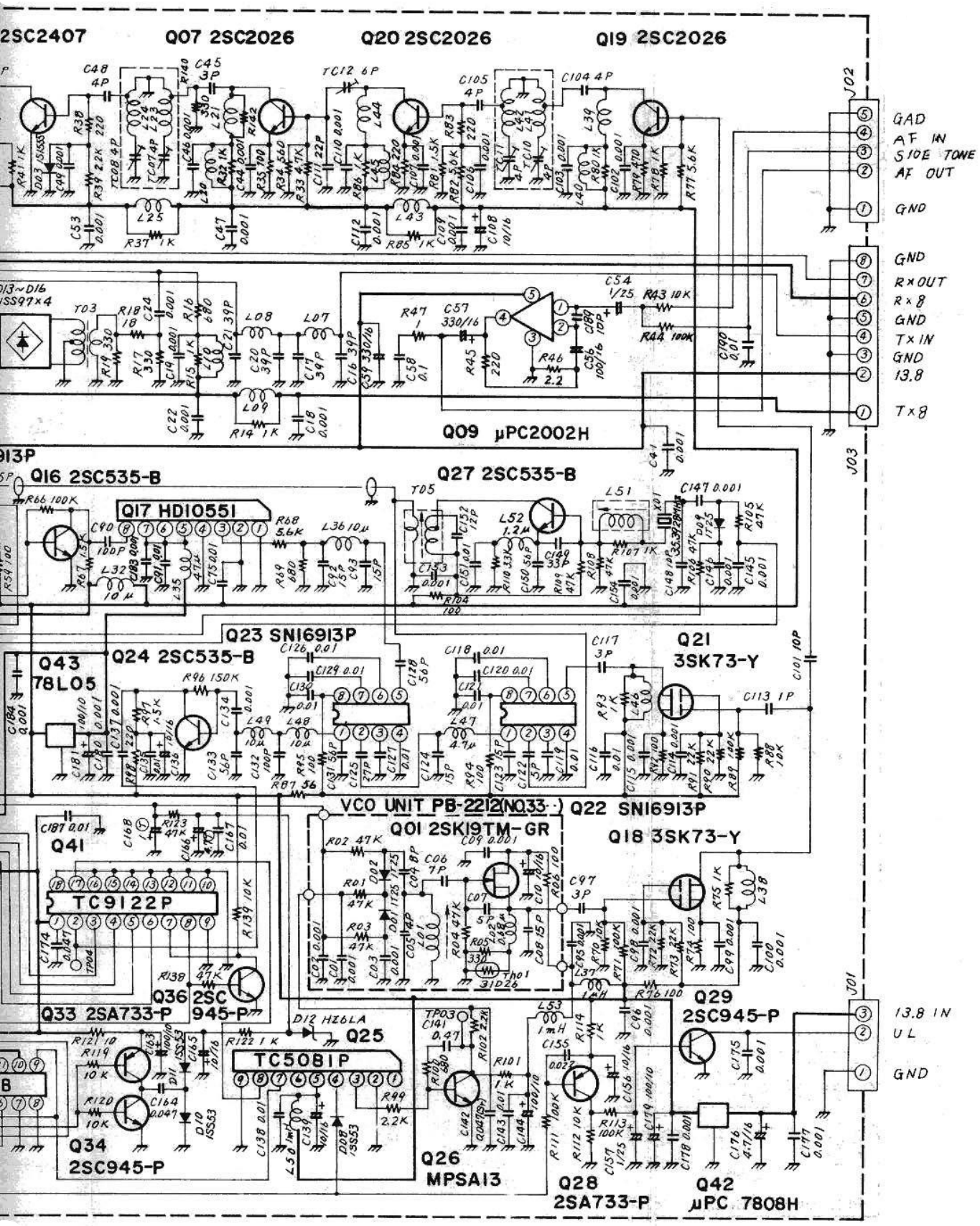

**FT-780R(BX)**  
**PLL UNIT**  
**CIRCUIT DIAGRAM**

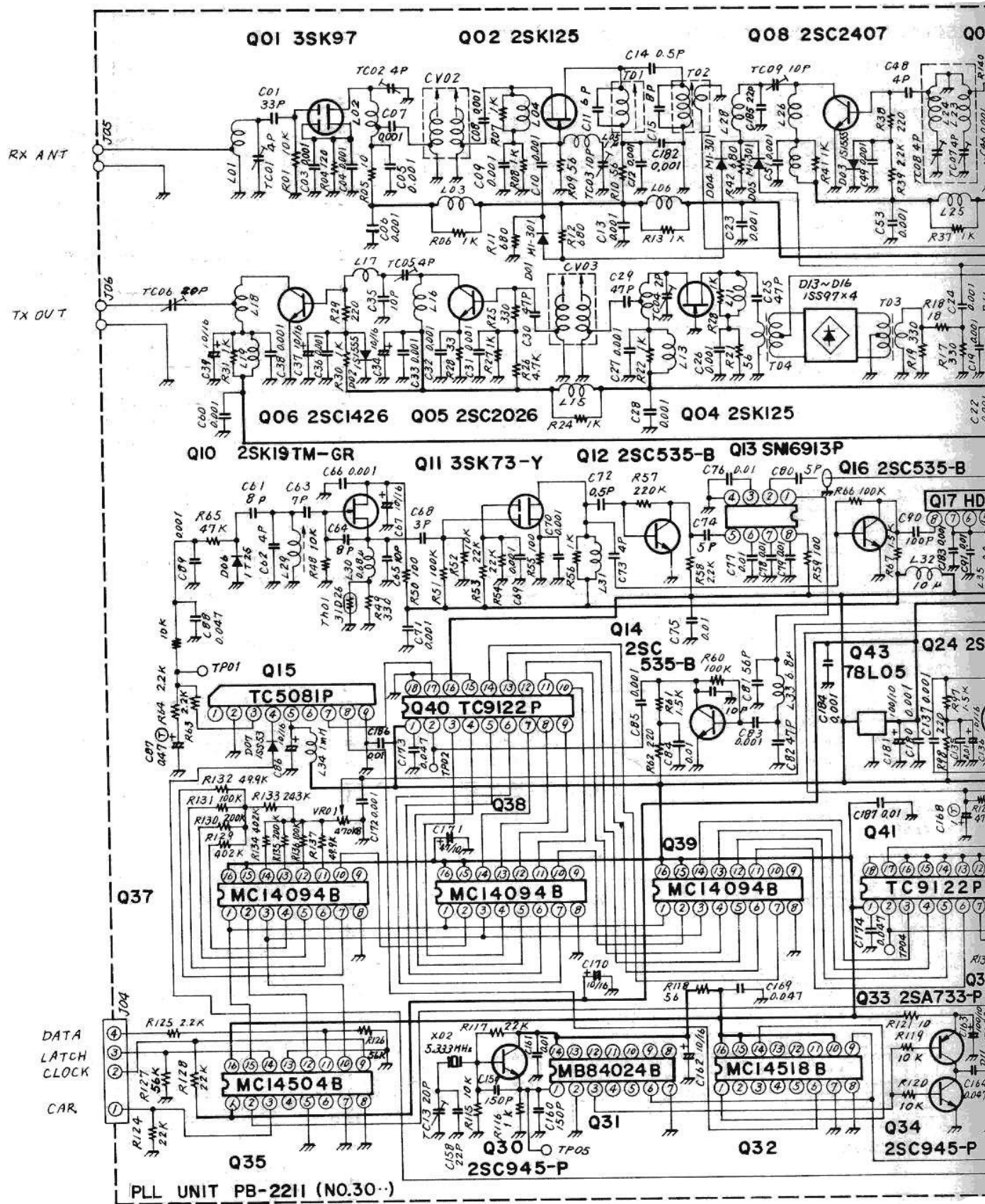

PLL UNIT PB-2211 (NO.30-)